

# Multilayer Diplexers

For GSM850/PCS Tx & Rx

## DPX Series

**Type:**            **DPX205850DT-4032A1 (2.0×1.25×0.95mm)**  
                      **DPX201990DT-4114A2 (2.0×1.25×0.95mm)**  
                      **DPX201990DT-4014A2 (2.0×1.25×0.95mm)**

**Issue date:**     December 2010

- All specifications are subject to change without notice.
  - Conformity to RoHS Directive: This means that, in conformity with EU Directive 2002/95/EC, lead, cadmium, mercury, hexavalent chromium, and specific bromine-based flame retardants, PBB and PBDE, have not been used, except for exempted applications.
-

# Multilayer Chip Diplexers For GSM850/PCS Tx & Rx

Conformity to RoHS Directive

DPX Series DPX205850DT-4032A1

## SHAPES AND DIMENSIONS

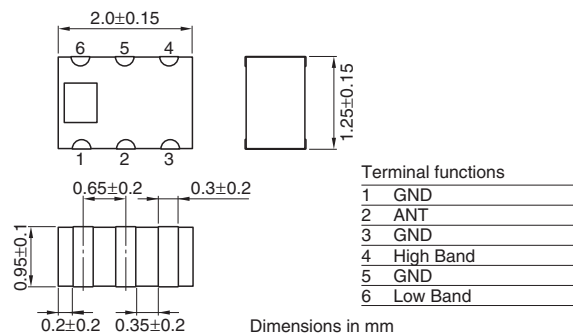

## RECOMMENDED PC BOARD PATTERNS

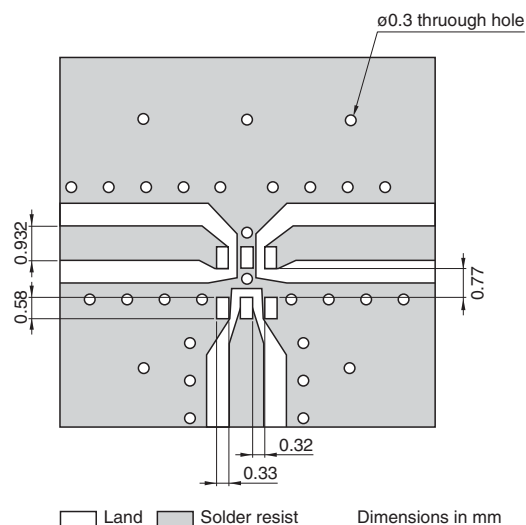

## ELECTRICAL CHARACTERISTICS

Item	Port	Frequency range		Minimum value	Typical value	Maximum value
Insertion loss	ANT Lo-band	800 to 2170MHz	(dB)	—	1.51	3.0
	ANT Hi-band	2400 to 5850MHz	(dB)	—	1.36	3.0
Attenuation	ANT Lo-band	2400 to 5850MHz	(dB)	8.0	12.7	—
	ANT Hi-band	800 to 2170MHz	(dB)	8.0	11.5	—
Temperature range	Operating		(°C)	-40	—	+85
	Storage		(°C)	-40	—	+85

• Ta: +25°C

• Conformity to RoHS Directive: This means that, in conformity with EU Directive 2002/95/EC, lead, cadmium, mercury, hexavalent chromium, and specific bromine-based flame retardants, PBB and PBDE, have not been used, except for exempted applications.

• All specifications are subject to change without notice.

### FREQUENCY CHARACTERISTICS

#### Lo-BAND PORT ATTENUATION S21

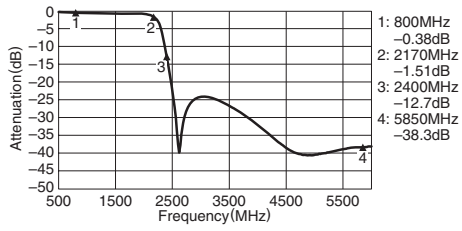

#### Hi-BAND PORT ATTENUATION S31

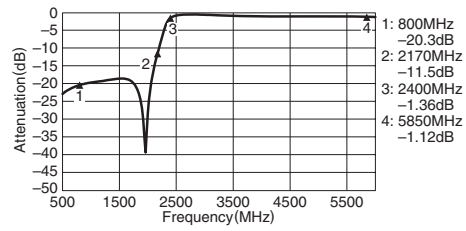

#### COMMON PORT RETURN LOSS S11

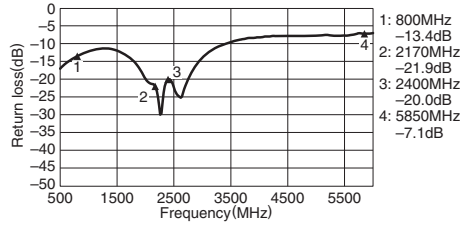

#### ISOLATION S23

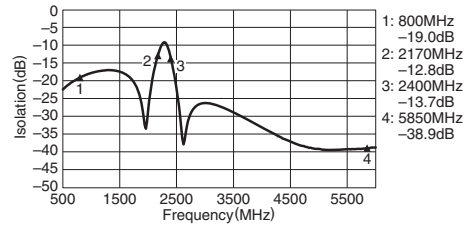

#### Lo-BAND PORT RETURN LOSS S22

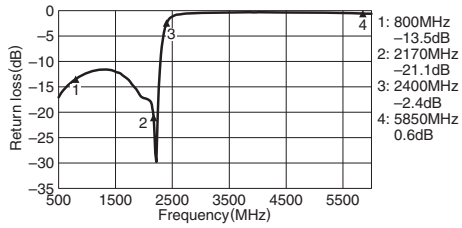

#### Hi-PORT RETURN LOSS S33

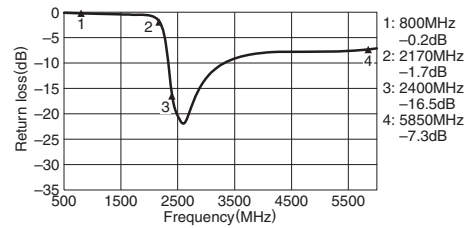

# Multilayer Chip Diplexers For GSM850/PCS Tx & Rx

Conformity to RoHS Directive

DPX Series DPX201990DT-4114A2

## SHAPES AND DIMENSIONS

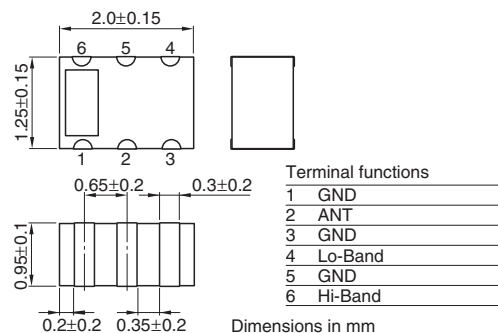

## RECOMMENDED PC BOARD PATTERNS

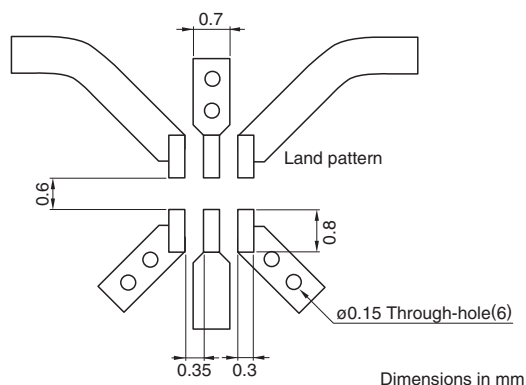

Line width be designed to match 50Ω characteristic impedance depending on PCB material and thickness.

## ELECTRICAL CHARACTERISTICS

Item	Port	Frequency range	Minimum value	Typical value	Maximum value
Insertion loss	Lo-band	[−40 to +85°C] 824 to 894MHz	(dB) —	—	0.5
	Hi-band	[−40 to +85°C] 1850 to 1990MHz	(dB) —	—	0.55
	Lo-band	[25°C] 824 to 894MHz	(dB) —	—	0.45
	Hi-band	[25°C] 1850 to 1990MHz	(dB) —	—	0.5
Return loss	ANT	824 to 894, 1850 to 1990MHz	(dB) 10.0	—	—
	Hi-band	824 to 894MHz	(dB) 19.0	—	—
Attenuation	Lo-band	1850 to 1990MHz	(dB) 20.0	—	—
	Lo-band	1648 to 1788MHz(AGSM 2fo)	(dB) 10.0	—	—
	Lo-band	2472 to 2682MHz(AGSM 3fo)	(dB) 28.0	—	—
Power capability			(W) —	—	3.0
Temperature range		Operating	(°C) −40	—	+85
		Storage	(°C) −40	—	+85

• Conformity to RoHS Directive: This means that, in conformity with EU Directive 2002/95/EC, lead, cadmium, mercury, hexavalent chromium, and specific bromine-based flame retardants, PBB and PBDE, have not been used, except for exempted applications.

• All specifications are subject to change without notice.

### FREQUENCY CHARACTERISTICS

#### Hi-BAND PORT S21

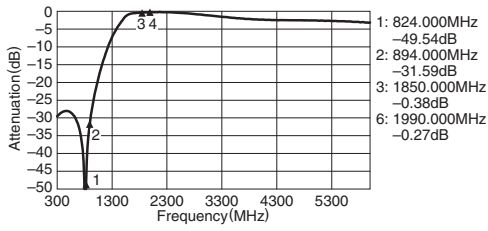

#### Lo-BAND PORT S31

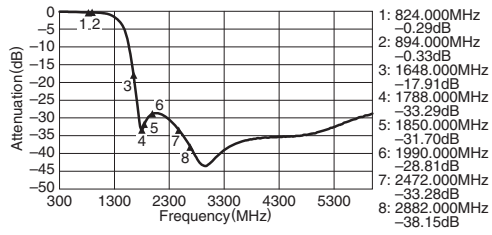

#### COMMON PORT RETURN LOSS S11

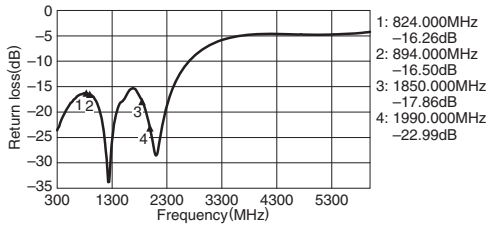

#### ISOLATION S23

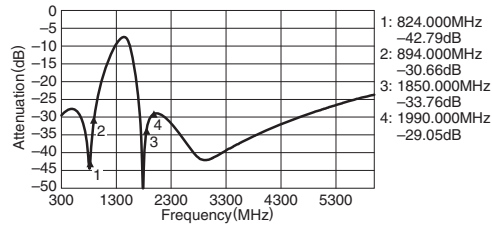

#### Hi-BAND PORT RETURN LOSS S22

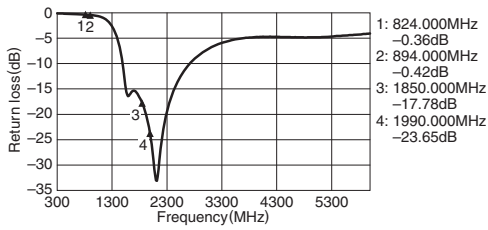

#### Lo-PORT RETURN LOSS S33

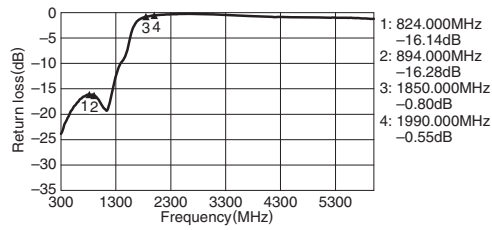

#### SMITH CHARTS

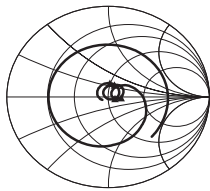

S11

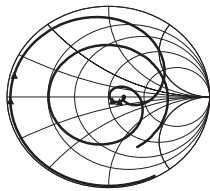

S22

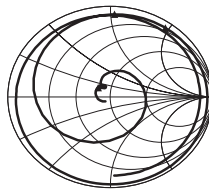

S33

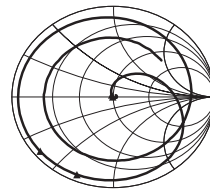

S21

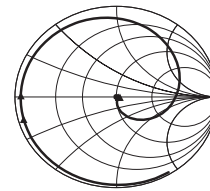

S31

# Multilayer Chip Diplexers For AGSM/PCS Tx/Rx

Conformity to RoHS Directive

DPX Series DPX201990DT-4014A2

## SHAPES AND DIMENSIONS

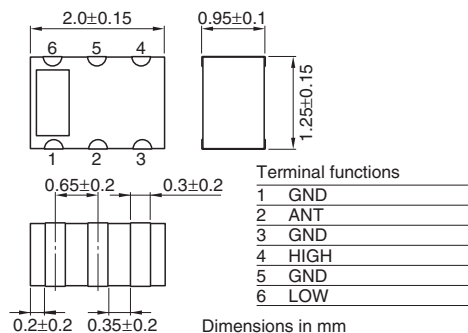

## RECOMMENDED PC BOARD PATTERNS

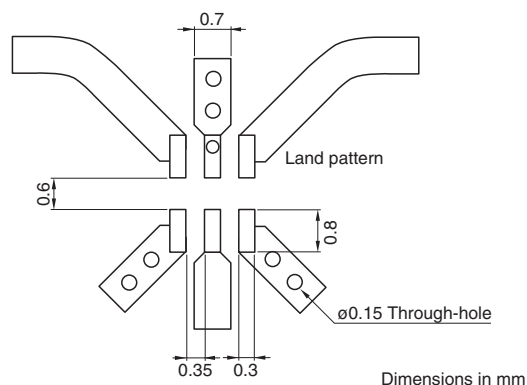

Line width be designed to match 50Ω characteristic impedance depending on PCB material and thickness.

## ELECTRICAL CHARACTERISTICS

Item	Port	Frequency range	Minimum value	Typical value	Maximum value
Insertion loss	Lo-band	[−40 to +85°C] 824 to 894MHz	(dB) —	—	0.5
	Hi-band	[−40 to +85°C] 1850 to 1990MHz	(dB) —	—	0.55
	Lo-band	[25°C] 824 to 894MHz	(dB) —	—	0.45
	Hi-band	[25°C] 1850 to 1990MHz	(dB) —	—	0.5
Return loss	ANT	824 to 894, 1850 to 1990MHz	(dB) 10.0	—	—
	Hi-band	824 to 894MHz	(dB) 19.0	—	—
Attenuation	Lo-band	1850 to 1990MHz	(dB) 20.0	—	—
	Lo-band	1648 to 1788MHz(AGSM 2fo)	(dB) 10.0	—	—
	Lo-band	2472 to 2682MHz(AGSM 3fo)	(dB) 28.0	—	—
Power capability			(W) —	—	3.0
Temperature range		Operating	(°C) −40	—	+85
		Storage	(°C) −40	—	+85

• Conformity to RoHS Directive: This means that, in conformity with EU Directive 2002/95/EC, lead, cadmium, mercury, hexavalent chromium, and specific bromine-based flame retardants, PBB and PBDE, have not been used, except for exempted applications.

• All specifications are subject to change without notice.

### FREQUENCY CHARACTERISTICS

#### Lo-BAND PORT S21

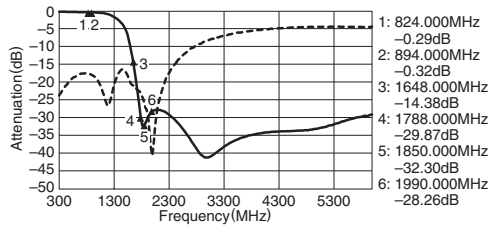

#### Hi-BAND PORT S31

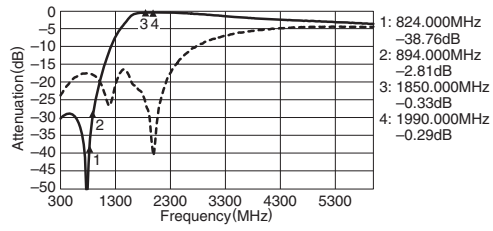

#### COMMON PORT RETURN LOSS S11

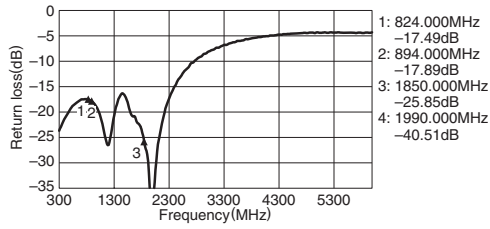

#### ISOLATION S23

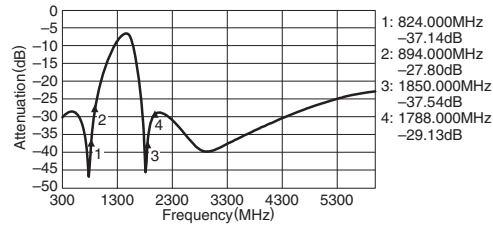

#### Lo-BAND PORT RETURN LOSS S22

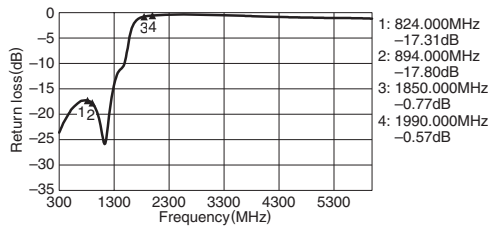

#### Hi-PORT RETURN LOSS S33

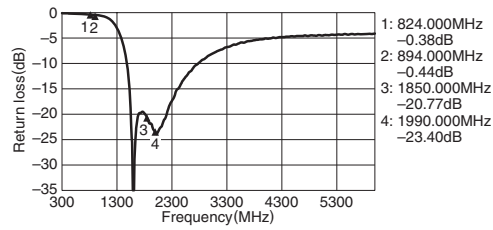

### SMITH CHARTS

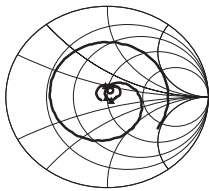

S11

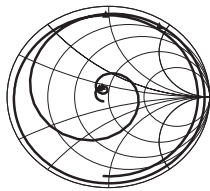

S22

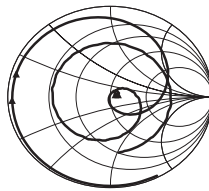

S33

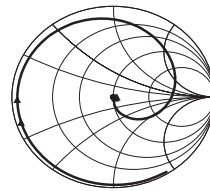

S21

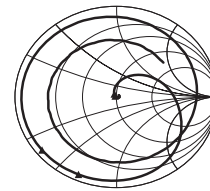

S31