

# MJE18002G

## SWITCHMODE™

### NPN Bipolar Power Transistor For Switching Power Supply Applications

The MJE18002G have an applications specific state-of-the-art die designed for use in 220 V line operated Switchmode Power supplies and electronic light ballasts.

#### Features

- Improved Efficiency Due to Low Base Drive Requirements:
  - ◆ High and Flat DC Current Gain  $h_{FE}$
  - ◆ Fast Switching
  - ◆ No Coil Required in Base Circuit for Turn-Off (No Current Tail)
- Tight Parametric Distributions are Consistent Lot-to-Lot
- Standard TO-220
- These Devices are Pb-Free and are RoHS Compliant\*

#### MAXIMUM RATINGS

Rating	Symbol	Value	Unit
Collector-Emitter Sustaining Voltage	$V_{CEO}$	450	Vdc
Collector-Emitter Breakdown Voltage	$V_{CES}$	1000	Vdc
Emitter-Base Voltage	$V_{EBO}$	9.0	Vdc
Collector Current – Continuous – Peak (Note 1)	$I_C$ $I_{CM}$	2.0 5.0	Adc
Base Current – Continuous – Peak (Note 1)	$I_B$ $I_{BM}$	1.0 2.0	Adc
Total Device Dissipation @ $T_C = 25^\circ\text{C}$ Derate above $25^\circ\text{C}$	$P_D$	50 0.4	W W/ $^\circ\text{C}$
Operating and Storage Temperature	$T_J, T_{stg}$	-65 to 150	$^\circ\text{C}$

#### THERMAL CHARACTERISTICS

Characteristics	Symbol	Max	Unit
Thermal Resistance, Junction-to-Case	$R_{\theta JC}$	2.5	$^\circ\text{C}/\text{W}$
Thermal Resistance, Junction-to-Ambient	$R_{\theta JA}$	62.5	$^\circ\text{C}/\text{W}$
Maximum Lead Temperature for Soldering Purposes 1/8" from Case for 5 Seconds	$T_L$	260	$^\circ\text{C}$

Stresses exceeding Maximum Ratings may damage the device. Maximum Ratings are stress ratings only. Functional operation above the Recommended Operating Conditions is not implied. Extended exposure to stresses above the Recommended Operating Conditions may affect device reliability.

1. Pulse Test: Pulse Width = 5 ms, Duty Cycle  $\leq 10\%$ .



ON Semiconductor®

<http://onsemi.com>

**POWER TRANSISTOR  
2.0 AMPERES  
100 VOLTS – 50 WATTS**

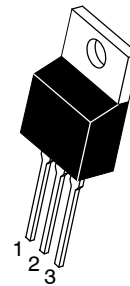

TO-220AB  
CASE 221A-09  
STYLE 1

#### MARKING DIAGRAM

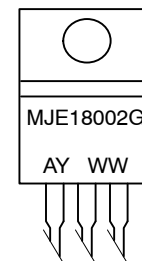

A = Assembly Location  
Y = Year  
WW = Work Week  
G = Pb-Free Package

#### ORDERING INFORMATION

Device	Package	Shipping
MJE18002G	TO-220 (Pb-Free)	50 Units / Rail

\*For additional information on our Pb-Free strategy and soldering details, please download the ON Semiconductor Soldering and Mounting Techniques Reference Manual, SOLDERRM/D.

# MJE18002G

## ELECTRICAL CHARACTERISTICS (T<sub>C</sub> = 25°C unless otherwise noted)

Characteristic				Symbol	Min	Typ	Max	Unit	
<b>OFF CHARACTERISTICS</b>									
Collector-Emitter Sustaining Voltage (I <sub>C</sub> = 100 mA, L = 25 mH)				V <sub>CEO(sus)</sub>	450	–	–	Vdc	
Collector Cutoff Current (V <sub>CE</sub> = Rated V <sub>CEO</sub> , I <sub>B</sub> = 0)				I <sub>CEO</sub>	–	–	100	μAdc	
Collector Cutoff Current (V <sub>CE</sub> = Rated V <sub>CE(s)</sub> , V <sub>EB</sub> = 0) (V <sub>CE</sub> = 800 V, V <sub>EB</sub> = 0)				I <sub>CES</sub>	–	–	100	μAdc	
					–	–	500		
					–	–	100		
Emitter Cutoff Current (V <sub>EB</sub> = 9.0 Vdc, I <sub>C</sub> = 0)				I <sub>EBO</sub>	–	–	100	μAdc	
<b>ON CHARACTERISTICS</b>									
Base-Emitter Saturation Voltage (I <sub>C</sub> = 0.4 Adc, I <sub>B</sub> = 40 mAdc) (I <sub>C</sub> = 1.0 Adc, I <sub>B</sub> = 0.2 Adc)				V <sub>BE(sat)</sub>	–	0.825	1.1	Vdc	
Collector-Emitter Saturation Voltage (I <sub>C</sub> = 0.4 Adc, I <sub>B</sub> = 40 mAdc)  (I <sub>C</sub> = 1.0 Adc, I <sub>B</sub> = 0.2 Adc)				V <sub>CE(sat)</sub>	–	0.2	0.5	Vdc	
					@ T <sub>C</sub> = 125°C	–	0.2		0.5
					@ T <sub>C</sub> = 125°C	–	0.25		0.5
					@ T <sub>C</sub> = 125°C	–	0.3		0.6
DC Current Gain (I <sub>C</sub> = 0.2 Adc, V <sub>CE</sub> = 5.0 Vdc)				h <sub>FE</sub>	14	–	34	–	
(I <sub>C</sub> = 0.4 Adc, V <sub>CE</sub> = 1.0 Vdc)					@ T <sub>C</sub> = 125°C	–	27		–
					@ T <sub>C</sub> = 125°C	11	17		–
(I <sub>C</sub> = 1.0 Adc, V <sub>CE</sub> = 1.0 Vdc)					@ T <sub>C</sub> = 125°C	11	20		–
					@ T <sub>C</sub> = 125°C	6.0	8.0		–
(I <sub>C</sub> = 10 mAdc, V <sub>CE</sub> = 5.0 Vdc)					@ T <sub>C</sub> = 125°C	5.0	8.0		–
				@ T <sub>C</sub> = 125°C	10	20	–		
<b>DYNAMIC CHARACTERISTICS</b>									
Current Gain Bandwidth (I <sub>C</sub> = 0.2 Adc, V <sub>CE</sub> = 10 Vdc, f = 1.0 MHz)				f <sub>T</sub>	–	13	–	MHz	
Output Capacitance (V <sub>CB</sub> = 10 Vdc, I <sub>E</sub> = 0, f = 1.0 MHz)				C <sub>ob</sub>	–	35	60	pF	
Input Capacitance (V <sub>EB</sub> = 8.0 V)				C <sub>ib</sub>	–	400	600	pF	
Dynamic Saturation:  determined 1.0 μs and 3.0 μs after rising I <sub>B1</sub> reach 0.9 final I <sub>B1</sub> (see Figure 18)		I <sub>C</sub> = 0.4 A I <sub>B1</sub> = 40 mA V <sub>CC</sub> = 300 V	1.0 μs	@ T <sub>C</sub> = 125°C	V <sub>CE(dsat)</sub>	–	3.5	–	Vdc
			3.0 μs	@ T <sub>C</sub> = 125°C		–	8.0	–	
		I <sub>C</sub> = 1.0 A I <sub>B1</sub> = 0.2 A V <sub>CC</sub> = 300 V	1.0 μs	@ T <sub>C</sub> = 125°C		–	1.5	–	
			3.0 μs	@ T <sub>C</sub> = 125°C		–	3.8	–	
			1.0 μs	@ T <sub>C</sub> = 125°C		–	8.0	–	
			3.0 μs	@ T <sub>C</sub> = 125°C		–	14	–	
					–	2.0	–		
					–	7.0	–		

2. Proper strike and creepage distance must be provided.

# MJE18002G

## ELECTRICAL CHARACTERISTICS – continued ( $T_C = 25^\circ\text{C}$ unless otherwise noted)

Characteristic	Symbol	Min	Typ	Max	Unit
----------------	--------	-----	-----	-----	------

### SWITCHING CHARACTERISTICS: Resistive Load ( $D.C. \leq 10\%$ , Pulse Width = 20 $\mu\text{s}$ )

Turn-On Time	$I_C = 0.4 \text{ Adc}$ $I_{B1} = 40 \text{ mAdc}$ $I_{B2} = 0.2 \text{ Adc}$ $V_{CC} = 300 \text{ V}$	@ $T_C = 125^\circ\text{C}$	$t_{on}$	– –	200 130	300 –	ns
Turn-Off Time		@ $T_C = 125^\circ\text{C}$	$t_{off}$	– –	1.2 1.5	2.5 –	$\mu\text{s}$
Turn-On Time	$I_C = 1.0 \text{ Adc}$ $I_{B1} = 0.2 \text{ Adc}$ $I_{B2} = 0.5 \text{ Adc}$ $V_{CC} = 300 \text{ V}$	@ $T_C = 125^\circ\text{C}$	$t_{on}$	– –	85 95	150 –	ns
Turn-Off Time		@ $T_C = 125^\circ\text{C}$	$t_{off}$	– –	1.7 2.1	2.5 –	$\mu\text{s}$

### SWITCHING CHARACTERISTICS: Inductive Load ( $V_{clamp} = 300 \text{ V}$ , $V_{CC} = 15 \text{ V}$ , $L = 200 \mu\text{H}$ )

Fall Time	$I_C = 0.4 \text{ Adc}$ , $I_{B1} = 40 \text{ mAdc}$ , $I_{B2} = 0.2 \text{ Adc}$	@ $T_C = 125^\circ\text{C}$	$t_{fi}$	– –	125 120	200 –	ns
Storage Time		@ $T_C = 125^\circ\text{C}$	$t_{si}$	– –	0.7 0.8	1.25 –	$\mu\text{s}$
Crossover Time		@ $T_C = 125^\circ\text{C}$	$t_c$	– –	110 110	200 –	ns
Fall Time	$I_C = 1.0 \text{ Adc}$ , $I_{B1} = 0.2 \text{ Adc}$ , $I_{B2} = 0.5 \text{ Adc}$	@ $T_C = 125^\circ\text{C}$	$t_{fi}$	– –	110 120	175 –	ns
Storage Time		@ $T_C = 125^\circ\text{C}$	$t_{si}$	– –	1.7 2.25	2.75 –	$\mu\text{s}$
Crossover Time		@ $T_C = 125^\circ\text{C}$	$t_c$	– –	200 250	300 –	ns
Fall Time	$I_C = 0.4 \text{ Adc}$ , $I_{B1} = 50 \text{ mAdc}$ , $I_{B2} = 50 \text{ mAdc}$	@ $T_C = 125^\circ\text{C}$	$t_{fi}$	– –	140 185	200 –	ns
Storage Time		@ $T_C = 125^\circ\text{C}$	$t_{si}$	– –	2.2 2.5	3.0 –	$\mu\text{s}$
Crossover Time		@ $T_C = 125^\circ\text{C}$	$t_c$	– –	140 220	250 –	ns

TYPICAL STATIC CHARACTERISTICS

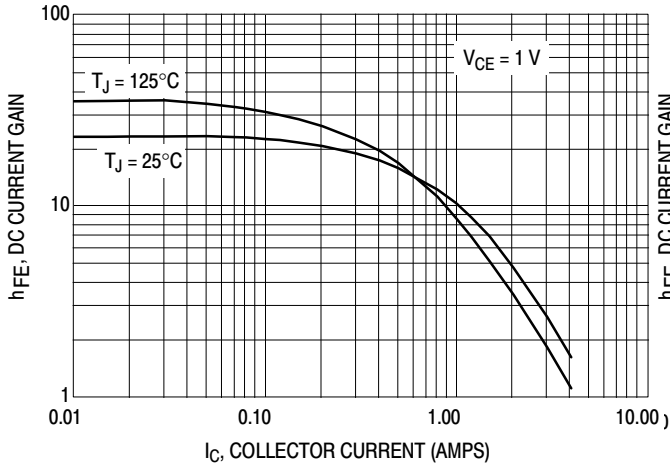

Figure 1. DC Current Gain @ 1 Volt

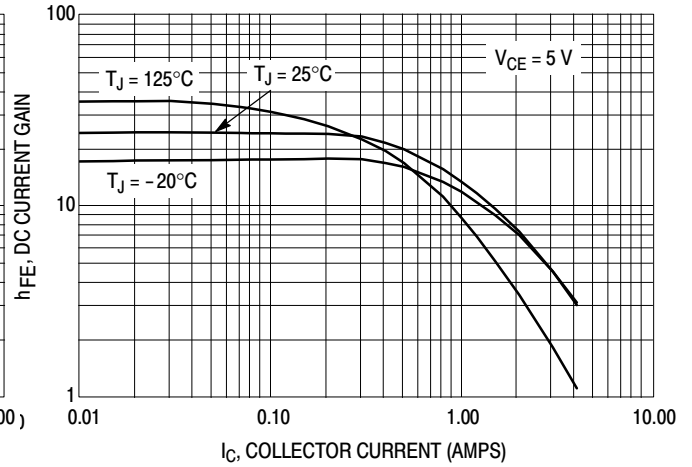

Figure 2. DC Current Gain @ 5 Volts

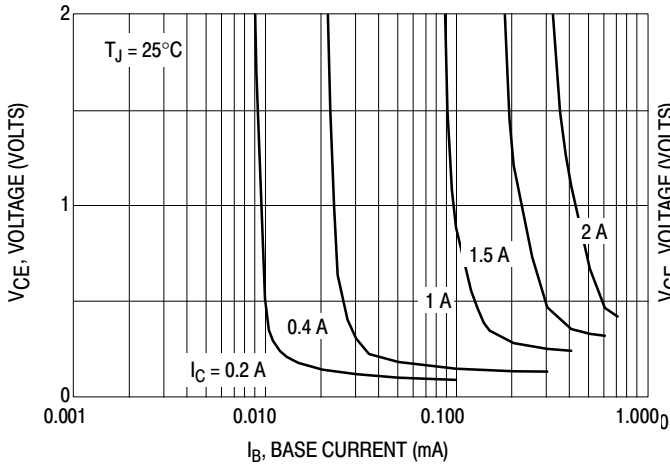

Figure 3. Collector Saturation Region

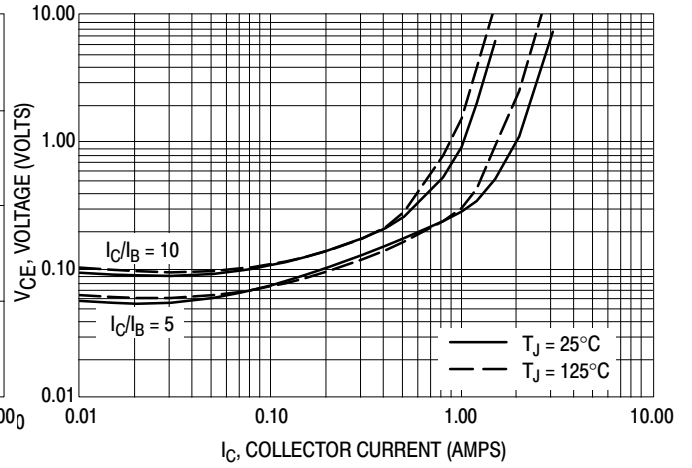

Figure 4. Collector-Emitter Saturation Voltage

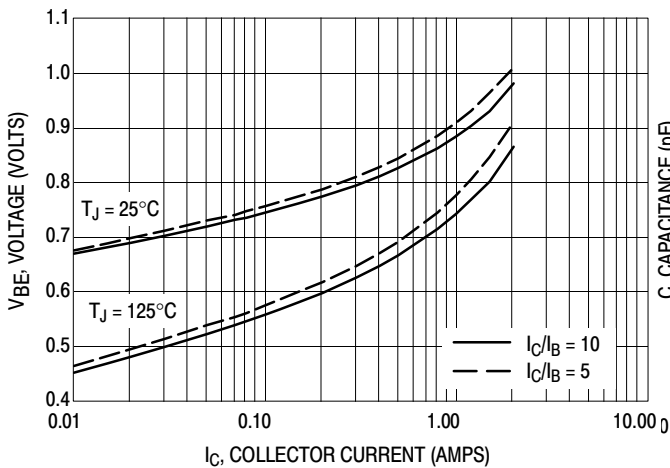

Figure 5. Base-Emitter Saturation Region

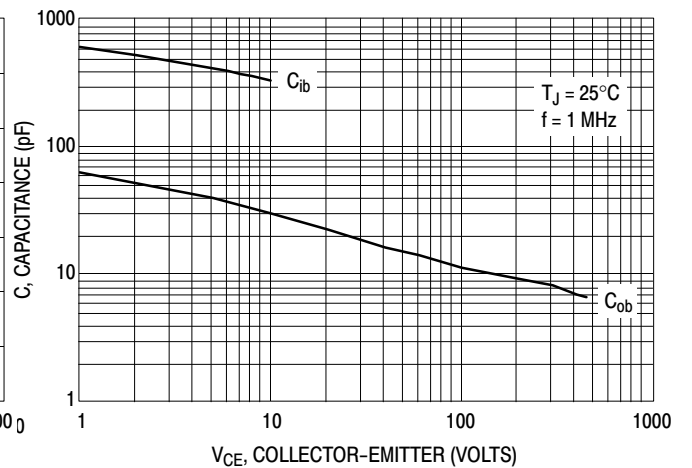

Figure 6. Capacitance

TYPICAL SWITCHING CHARACTERISTICS  
( $I_{B2} = I_C/2$  for all switching)

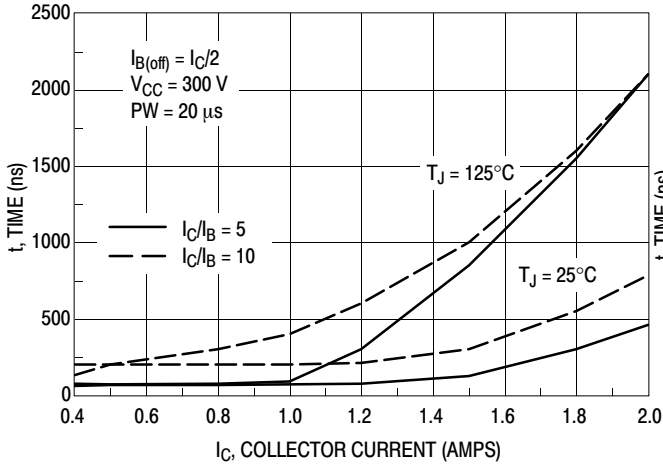

Figure 7. Resistive Switching,  $t_{on}$

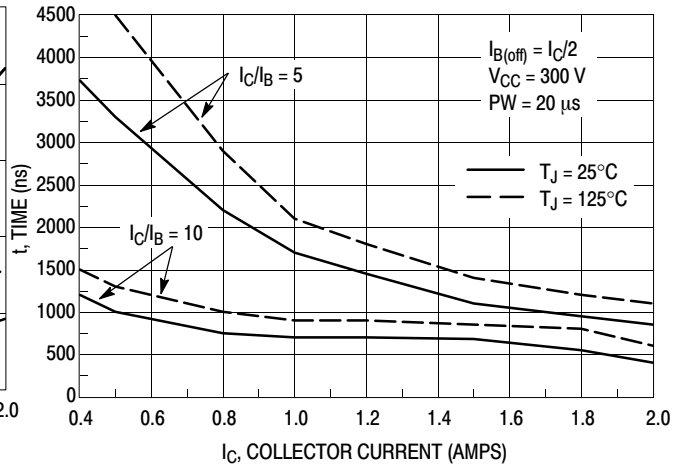

Figure 8. Resistive Switching,  $t_{off}$

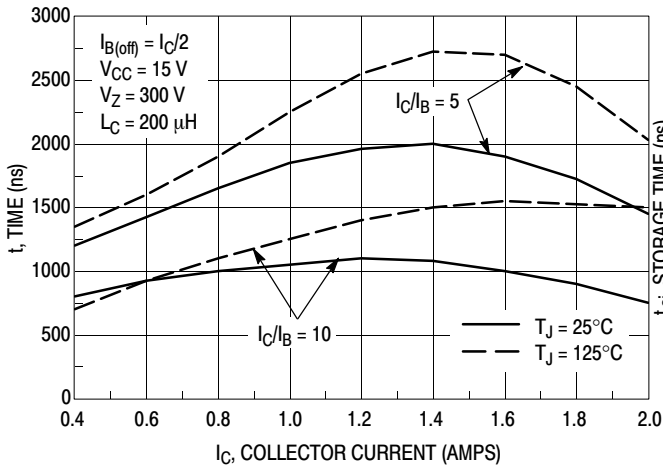

Figure 9. Inductive Storage Time,  $t_{si}$

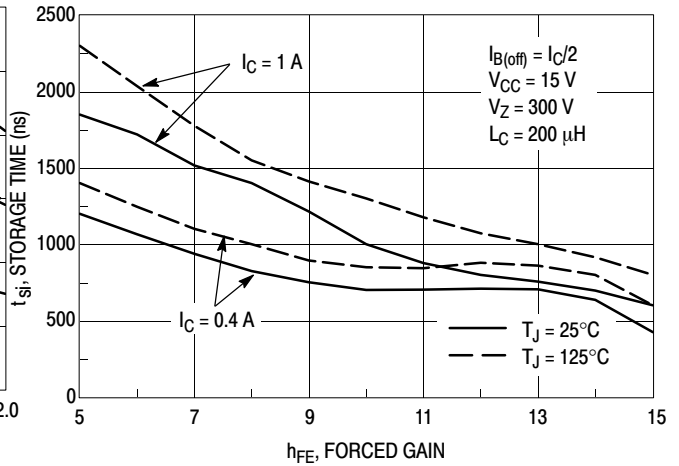

Figure 10. Inductive Storage Time

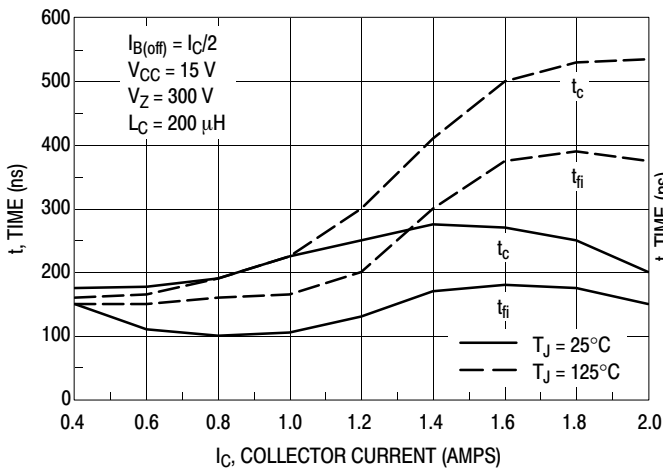

Figure 11. Inductive Switching,  $t_c$  and  $t_{fi}$ ,  $I_C/I_B = 5$

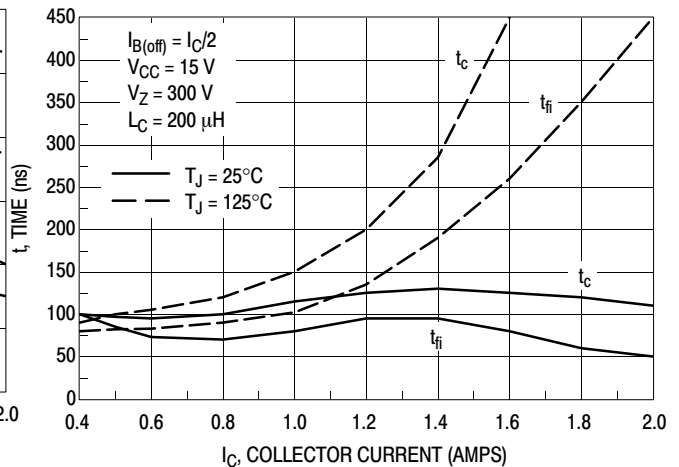

Figure 12. Inductive Switching,  $t_c$  and  $t_{fi}$ ,  $I_C/I_B = 10$

# MJE18002G

## TYPICAL SWITCHING CHARACTERISTICS ( $I_{B2} = I_C/2$ for all switching)

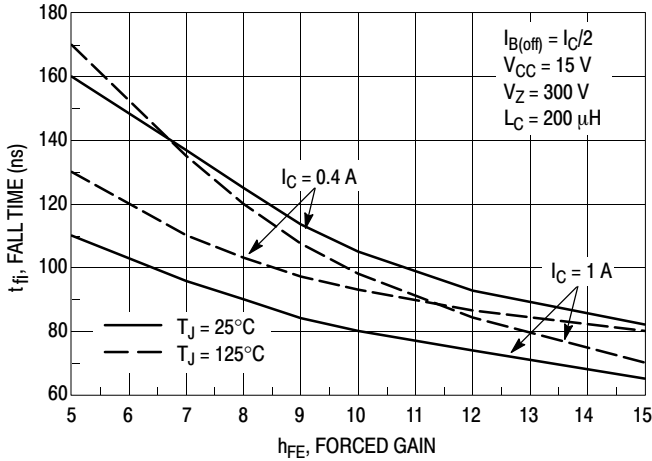

Figure 13. Inductive Fall Time

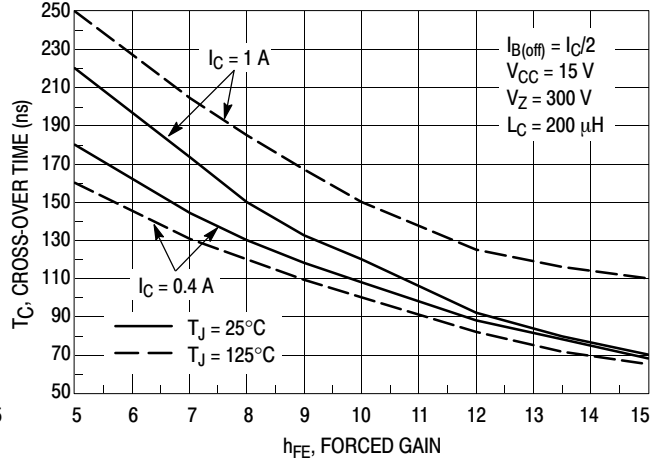

Figure 14. Inductive Crossover Time

## GUARANTEED SAFE OPERATING AREA INFORMATION

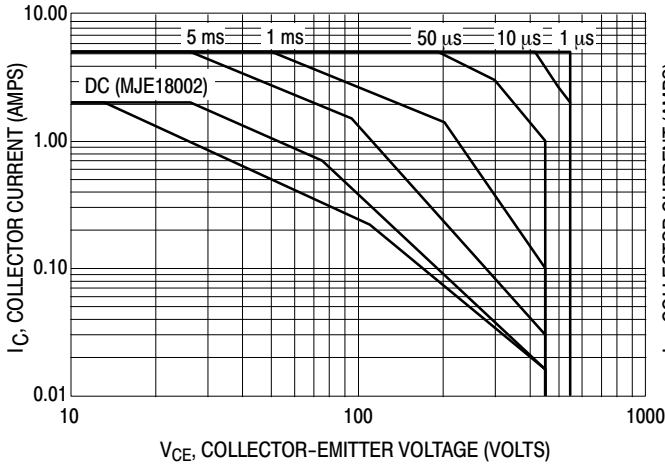

Figure 15. Forward Bias Safe Operating Area

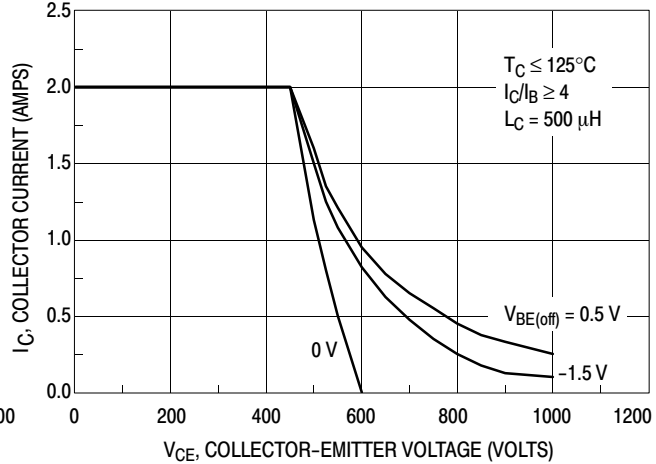

Figure 16. Reverse Bias Switching Safe Operating Area

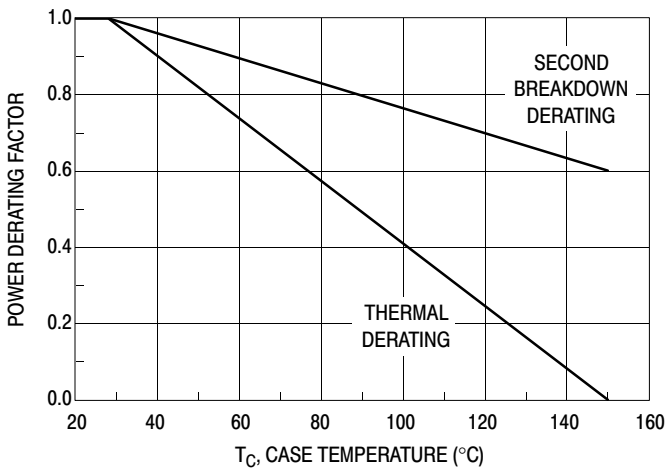

Figure 17. Forward Bias Power Derating

There are two limitations on the power handling ability of a transistor: average junction temperature and second breakdown. Safe operating area curves indicate  $I_C$ - $V_{CE}$  limits of the transistor that must be observed for reliable operation; i.e., the transistor must not be subjected to greater dissipation than the curves indicate. The data of Figure 15 is based on  $T_C = 25^\circ\text{C}$ ;  $T_J(\text{pk})$  is variable depending on power level. Second breakdown pulse limits are valid for duty cycles to 10% but must be derated when  $T_C > 25^\circ\text{C}$ . Second breakdown limitations do not derate the same as thermal limitations. Allowable current at the voltages shown on Figure 15 may be found at any case temperature by using the appropriate curve on Figure 17.  $T_J(\text{pk})$  may be calculated from the data in Figures 20. At any case temperatures, thermal limitations will reduce the power that can be handled to values less the limitations imposed by second breakdown. For inductive loads, high voltage and current must be sustained simultaneously during turn-off with the base to emitter junction reverse biased. The safe level is specified as a reverse biased safe operating area (Figure 16). This rating is verified under clamped conditions so that the device is never subjected to an avalanche mode.

# MJE1802G

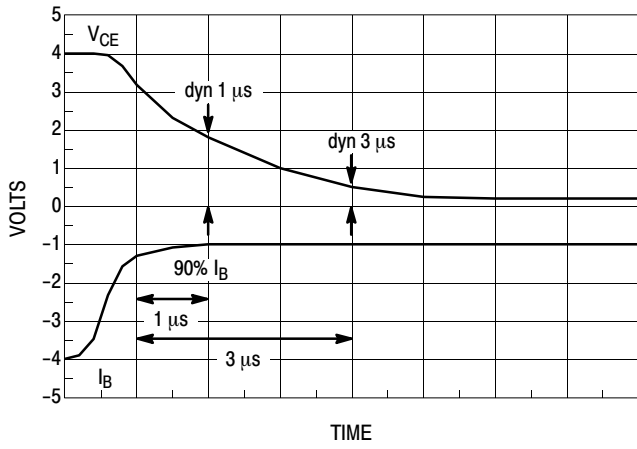

Figure 18. Dynamic Saturation Voltage Measurements

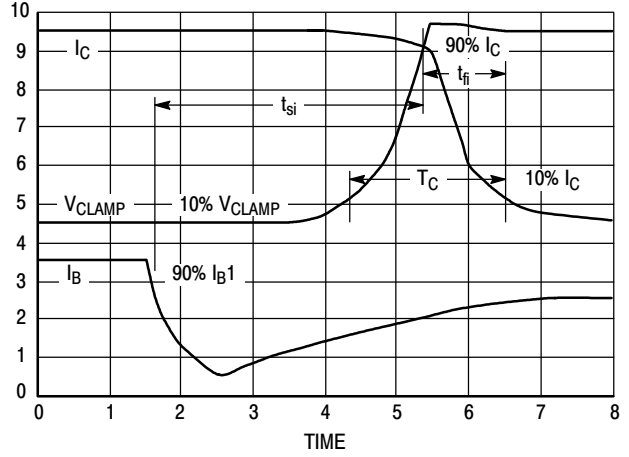
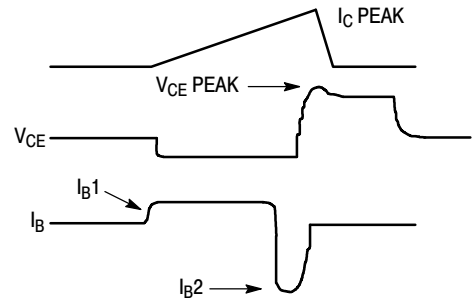
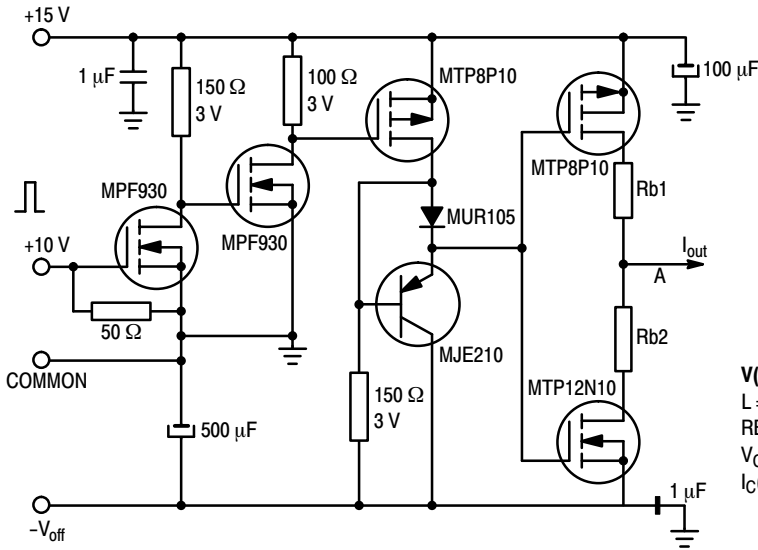

Figure 19. Inductive Switching Measurements



V(BR)CEO(sus)	INDUCTIVE SWITCHING	RBSOA
L = 10 μH	L = 200 μH	L = 500 μH
RB2 = ∞	RB2 = 0	RB2 = 0
VCC = 20 VOLTS	VCC = 15 VOLTS	VCC = 15 VOLTS
IC(pk) = 100 mA	RB1 SELECTED FOR DESIRED IB1	RB1 SELECTED FOR DESIRED IB1

Table 1. Inductive Load Switching Drive Circuit

## TYPICAL THERMAL RESPONSE

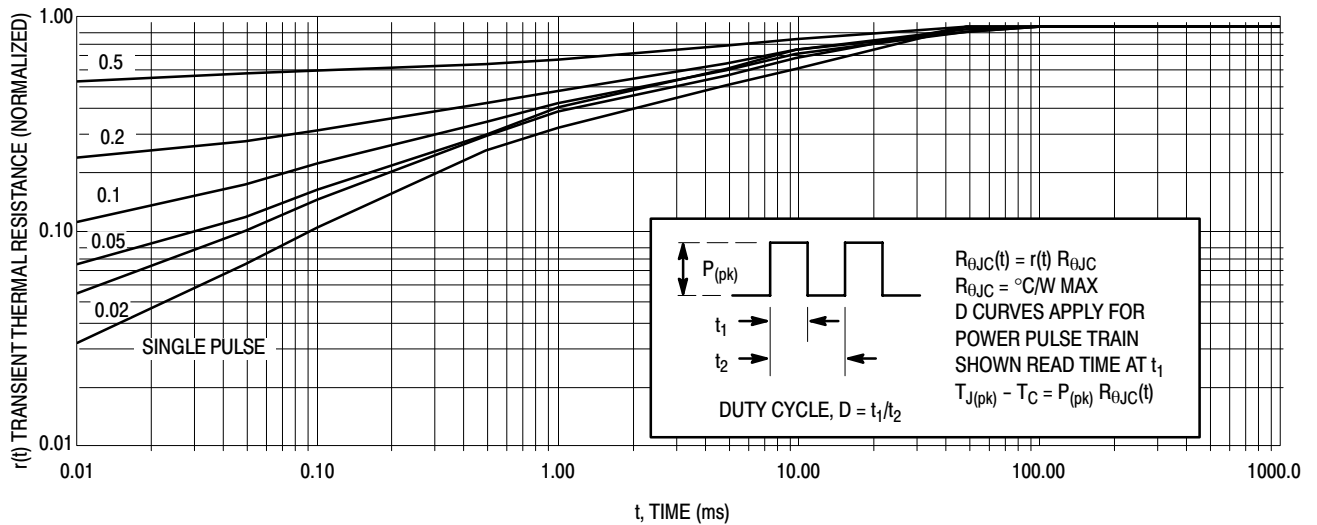
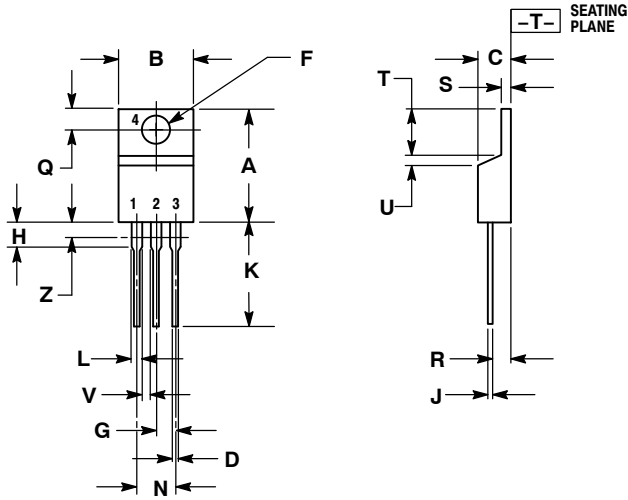

Figure 20. Typical Thermal Response ( $Z_{\theta JC}(t)$ ) for MJE1802

# MJE18002G

## PACKAGE DIMENSIONS

TO-220AB  
CASE 221A-09  
ISSUE AF



**NOTES:**

1. DIMENSIONING AND TOLERANCING PER ANSI Y14.5M, 1982.
2. CONTROLLING DIMENSION: INCH.
3. DIMENSION Z DEFINES A ZONE WHERE ALL BODY AND LEAD IRREGULARITIES ARE ALLOWED.

DIM	INCHES		MILLIMETERS	
	MIN	MAX	MIN	MAX
A	0.570	0.620	14.48	15.75
B	0.380	0.405	9.66	10.28
C	0.160	0.190	4.07	4.82
D	0.025	0.035	0.64	0.88
F	0.142	0.161	3.61	4.09
G	0.095	0.105	2.42	2.66
H	0.110	0.155	2.80	3.93
J	0.014	0.025	0.36	0.64
K	0.500	0.562	12.70	14.27
L	0.045	0.060	1.15	1.52
N	0.190	0.210	4.83	5.33
Q	0.100	0.120	2.54	3.04
R	0.080	0.110	2.04	2.79
S	0.045	0.055	1.15	1.39
T	0.235	0.255	5.97	6.47
U	0.000	0.050	0.00	1.27
V	0.045	---	1.15	---
Z	---	0.080	---	2.04

**STYLE 1:**

1. BASE
2. COLLECTOR
3. EMITTER
4. COLLECTOR

SWITCHMODE is a trademark of Semiconductor Components Industries, LLC.

ON Semiconductor and are registered trademarks of Semiconductor Components Industries, LLC (SCILLC). SCILLC reserves the right to make changes without further notice to any products herein. SCILLC makes no warranty, representation or guarantee regarding the suitability of its products for any particular purpose, nor does SCILLC assume any liability arising out of the application or use of any product or circuit, and specifically disclaims any and all liability, including without limitation special, consequential or incidental damages. "Typical" parameters which may be provided in SCILLC data sheets and/or specifications can and do vary in different applications and actual performance may vary over time. All operating parameters, including "Typicals" must be validated for each customer application by customer's technical experts. SCILLC does not convey any license under its patent rights nor the rights of others. SCILLC products are not designed, intended, or authorized for use as components in systems intended for surgical implant into the body, or other applications intended to support or sustain life, or for any other application in which the failure of the SCILLC product could create a situation where personal injury or death may occur. Should Buyer purchase or use SCILLC products for any such unintended or unauthorized application, Buyer shall indemnify and hold SCILLC and its officers, employees, subsidiaries, affiliates, and distributors harmless against all claims, costs, damages, and expenses, and reasonable attorney fees arising out of, directly or indirectly, any claim of personal injury or death associated with such unintended or unauthorized use, even if such claim alleges that SCILLC was negligent regarding the design or manufacture of the part. SCILLC is an Equal Opportunity/Affirmative Action Employer. This literature is subject to all applicable copyright laws and is not for resale in any manner.

### PUBLICATION ORDERING INFORMATION

**LITERATURE FULFILLMENT:**

Literature Distribution Center for ON Semiconductor  
P.O. Box 5163, Denver, Colorado 80217 USA  
Phone: 303-675-2175 or 800-344-3860 Toll Free USA/Canada  
Fax: 303-675-2176 or 800-344-3867 Toll Free USA/Canada  
Email: [orderlit@onsemi.com](mailto:orderlit@onsemi.com)

**N. American Technical Support:** 800-282-9855 Toll Free USA/Canada  
**Europe, Middle East and Africa Technical Support:**  
Phone: 421 33 790 2910  
**Japan Customer Focus Center**  
Phone: 81-3-5773-3850

**ON Semiconductor Website:** [www.onsemi.com](http://www.onsemi.com)

**Order Literature:** <http://www.onsemi.com/orderlit>

For additional information, please contact your local Sales Representative