



# MIC2870

## 1.5A Synchronous Boost Flash LED Driver with I<sup>2</sup>C Interface

### General Description

The MIC2870 is a high-current, high-efficiency flash LED driver for one or two high-brightness camera flash LEDs.

The LED driver current is generated by an integrated inductive boost converter with 2MHz switching frequency which allows the use of a very-small inductor and output capacitor. These features make the MIC2870 an ideal solution for high-resolution camera phone LED flashlight driver applications.

MIC2870 supports two 750mA white-LEDs (WLEDs) or a single 1.5A WLED configuration. When two WLEDs are connected, their currents are matched automatically.

MIC2870 operates in either flash or torch modes that can be controlled through either an I<sup>2</sup>C interface or external pins. The brightness in the flash and torch mode can be adjusted via two external resistors individually. High-speed mode I<sup>2</sup>C interface provides a simple control at a clock speed up to 3.4MHz to support most camera functions such as auto-focus, white balance, and image capture (flash mode).

The MIC2870 is available in 16-pin, 2mm x 2mm TQFN package with a junction temperature range of -40°C to +125°C.

Datasheets and support documentation are available on Micrel's web site at: [www.micrel.com](http://www.micrel.com).

### Features

- Up to 1.5A flash LED driving current
  - 2.7V to 5.0V input voltage range
- High-efficiency 2MHz V<sub>F</sub> adaptive boost driver
- Configurable 1 or 2 channel(s) WLED driver
- LED driving current soft-start
- Control through I<sup>2</sup>C interface or external pins
- Flash inhibit function for GSM pulse synchronization
- True load disconnect
- Flash time-out protection
- 1µA shutdown current
- Available in 16-pin 2mm x 2mm TQFN package

### Applications

- Camera phones/mobile handsets
- Cellular phones/smart phones
- LED light for image capture/auto focus/white balance
- Handset video light (torch light)
- Digital cameras
- Portable applications

### Typical Application

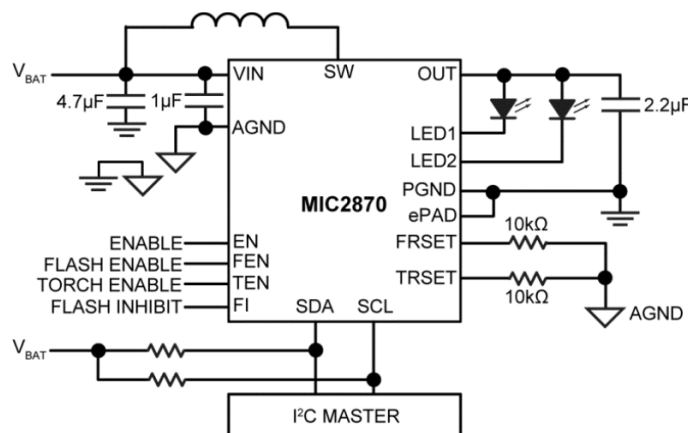

## Ordering Information

Part Number	Marking	Temperature Range	Package <sup>(1)</sup>	Lead Finish
MIC2870YFT	70H	-40°C to +125°C	16-Pin 2mm x 2mm TQFN	NiPdAu

### Note:

1. Package is a GREEN, RoHS-compliant package. Lead finish is NiPdAu. Mold compound is Halogen Free.
2. Thin QFN pin 1 identifier = "▲".

## Pin Configuration

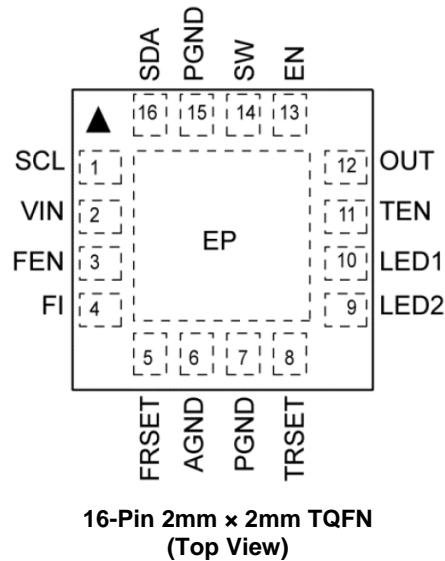

## Pin Description

Pin Number	Pin Name	Pin Function
1	SCL	High-Speed Mode (3.4MHz) I <sup>2</sup> C Clock Input.
2	VIN	Supply Input. Connect a low-ESR ceramic capacitor of at least 4.7μF to PGND. A small capacitor of 100nF between VIN and AGND is highly recommended.
3	FEN	Flash-Mode Enable Pin. A LOW-to-HIGH transition initiates the flash mode and flash-mode timer. If FEN is left floating, it is pulled-down internally by a built-in 1μA current source when the device is enabled.
4	FI	Flash Inhibit. When FI is pulled HIGH, both LED currents are changed from the flash-mode current level to the torch-mode current level. If FI is left floating, it is pulled-down internally by a built-in 1μA current source when the device is enabled. This function is generally used to reduce instantaneous battery load current by synchronizing with the handset's GSM pulse off time.
5	FRSET	Flash-Mode Current Level Programming. Connect a resistor from FRSET to AGND to set the maximum current in the flash mode. For example, a 10kΩ resistor sets the LED sink current to its maximum value of 750mA per channel. FRSET can be grounded if the default maximum flash-mode current (750mA) is desired. FRSET, however, cannot be left floating and the maximum resistance is limited to 80kΩ.
6	AGND	Analog Ground. Reference ground for FRSET and TRSET pins.

**Pin Description (Continued)**

Pin Number	Pin Name	Pin Function
7, 15	PGND	Power Ground. PGND is used for the switching NMOS and PMOS of boost converter, and power ground for LED current sinks.
8	TRSET	Torch-Mode Current Level Programming. Connect a resistor from TRSET to AGND to set the maximum current in the torch mode. For example, a 10k $\Omega$ resistor sets the LED sink current to its maximum value of 187.5mA per channel. TRSET can be grounded if the default maximum torch-mode current (187.5mA) is desired. TRSET, however, cannot be left floating and the maximum resistance is limited to 80k $\Omega$ .
9	LED2	Channel 2 LED Current Sink. Connect the LED anode to OUT and cathode to LED2.
10	LED1	Channel 1 LED Current Sink. Connect the LED anode to OUT and cathode to LED1.
11	TEN	Torch-Mode Enable. Initiates torch mode when TEN is HIGH. If TEN is left floating, it is pulled-down internally by a built-in 1 $\mu$ A current source when the device is enabled.
12	OUT	Boost Converter Output.
13	EN	Enable (IC). The MIC2870 is in standby mode when EN is asserted HIGH. If EN is driven low for more than 1s, the IC is shut down. Alternatively, the I <sup>2</sup> C interface can be used for enabling/disabling the IC through the master control/status register. EN is pulled down by an internal resistor.
14	SW	Inductor Connection. It is connected to the internal power MOSFETs.
16	SDA	High-Speed Mode (3.4MHz) I <sup>2</sup> C Data Input/Output.
EP	ePad	Exposed Heat Sink Pad. Connect to PGND ground plane for best thermal performance. This pin is internally connected to PGND.

### Absolute Maximum Ratings<sup>(3)</sup>

Supply Voltage ( $V_{IN}$ )	-0.3V to +6.0V
Enable Input Voltage ( $V_{EN}$ , $V_{FEN}$ , $V_{FI}$ , $V_{TEN}$ )	-0.3V to $V_{IN} + 0.3V$
$V_{OUT}$ , $V_{LED1}$ , and $V_{LED2}$	-0.3V to 6.0V
I <sup>2</sup> C I/O ( $V_{SCL}$ , $V_{SDA}$ )	-0.3V to $V_{IN} + 0.3V$
$V_{FRSET}$ and $V_{TRSET}$	-0.3V to $V_{IN} + 0.3V$
$V_{SW}$	-0.3V to 6.0V
Power Dissipation <sup>(5)</sup> ( $P_{DISS}$ )	Internally Limited
Lead Temperature (soldering, 10s)	+260°C
Junction Temperature ( $T_J$ )	-40°C to +150°C
Storage Temperature ( $T_S$ )	-40°C to +150°C
ESD Rating <sup>(6)</sup>	2kV HBM and 150V MM

### Operating Ratings<sup>(4)</sup>

Supply Voltage ( $V_{IN}$ )	+2.7V to +5.0V
Enable Input Voltage ( $V_{EN}$ , $V_{FEN}$ , $V_{FI}$ , $V_{TEN}$ )	0V to $V_{IN}$
I <sup>2</sup> C I/O ( $V_{SCL}$ , $V_{SDA}$ )	0V to $V_{IN}$
Junction Temperature ( $T_J$ )	-40°C to 125°C
Package Thermal Resistance <sup>(5)</sup> 2mm x 2mm TQFN ( $\theta_{JA}$ )	80°C/W

### Electrical Characteristics<sup>(7)</sup>

$V_{IN} = 3.6V$ ;  $L = 1\mu H$ ,  $C_{OUT} = 2.2\mu F$ ,  $R_{FRSET} = 10k\Omega$ ,  $R_{TRSET} = 10k\Omega$ ,  $I_{LED} = 100mA$ ;  $T_A = 25^\circ C$ , **bold** values indicate  $-40^\circ C \leq T_J \leq 125^\circ C$ , unless otherwise noted.

Symbol	Parameter	Condition	Min.	Typ.	Max.	Units
<b>Power Supply</b>						
$V_{IN}$	Input Voltage		<b>2.7</b>		<b>5.0</b>	V
$I_{VIN}$	Quiescent Current	$V_{LED1} = V_{LED2} > 200mV$ , not switching		0.9		mA
		$V_{LED1} = V_{LED2} = 70mV$ , boost keeps switching		4.2		
$I_{VIN(SD)}$	Shutdown Current	$V_{EN} = 0V$		0.6		$\mu A$
$I_{SW(SD)}$	SW Pin Shutdown Current	$V_{EN} = 0V$		1	<b>5</b>	$\mu A$
UVLO_Rise	UVLO Threshold (Rising)		2.35	2.5	2.65	V
UVLO_Hyst	UVLO Hysteresis			300		mV
$V_{OUT}$	Output Voltage	$V_{IN} \geq V_{OUT}$			$V_{IN}$	V
		$V_{OUT} > V_{IN}$			5.2	
$V_{OVP}$	Overvoltage Protection Threshold	$V_{OUT} > V_{IN}$	<b>5.26</b>	5.38	<b>5.6</b>	V
	Overvoltage Protection Hysteresis			60		mV
	OVP Blanking Time			24		$\mu s$
$D_{MAX}$	Maximum Duty Cycle		80	85	90	%
$D_{MIN}$	Minimum Duty Cycle			5.5		%
$I_{SW\_OC}$	Switch Current Limit	$V_{IN} = V_{OUT} = 2.7V$	<b>3.35</b>	4.5	<b>5.65</b>	A

**Notes:**

- Exceeding the absolute maximum ratings may damage the device.
- The device is not guaranteed to function outside its operating ratings.
- The maximum allowable power dissipation of any  $T_A$  (ambient temperature) is  $P_{DISS(max)} = (T_{J(max)} - T_A) / \theta_{JA}$ . Exceeding the maximum allowable power dissipation will result in excessive die temperature, and the regulator will go into thermal shutdown.
- Devices are ESD sensitive. Handling precautions are recommended. Human body model, 1.5k $\Omega$  in series with 100pF.
- Specification for packaged product only

## Electrical Characteristics<sup>(7)</sup> (Continued)

$V_{IN} = 3.6V$ ;  $L = 1\mu H$ ,  $C_{OUT} = 2.2\mu F$ ,  $R_{FRSET} = 10k\Omega$ ,  $R_{TRSET} = 10k\Omega$ ,  $I_{LED} = 100mA$ ;  $T_A = 25^\circ C$ , **bold** values indicate  $-40^\circ C \leq T_J \leq 125^\circ C$ , unless otherwise noted.

Symbol	Parameter	Condition	Min.	Typ.	Max.	Units
$F_{SW}$	Oscillator Frequency		1.8	2.0	2.2	MHz
$R_{ON(N)}$	Switch On-Resistance	$V_{VIN} = 2.7 V$ , $I_{SW} = 750 mA$		80		m $\Omega$
$R_{ON(P)}$		$V_{SW} = 2.7 V$ , $I_{OUT} = 750 mA$		80		
$I_{LK(N)}$	NMOS Switch Leakage Current	$V_{EN} = 0 V$ , $V_{IN} = V_{SW} = V_{OUT} = 5 V$		1	<b>5</b>	$\mu A$
$I_{LK(P)}$	PMOS Switch Leakage Current	$V_{EN} = 0 V$ , $V_{IN} = V_{OUT} = 5 V$ , $V_{SW} = 0 V$		1	<b>5</b>	$\mu A$
$R_{DCHG}$	Auto-Discharge NMOS Resistance	$V_{EN} = 0 V$ , $I_{OUT} = -1 mA$		160		$\Omega$
$T_{SD}$	Overtemperature Shutdown Threshold			160		$^\circ C$
$T_{SD\_HYST}$	Overtemperature Shutdown Hysteresis			25		$^\circ C$
$T_{FLASH\_TIMEOUT}$	Flash Safety Timeout Shutdown	Maximum timeout setting		1.25		s
<b>Current Sink Channels</b>						
$ACC_{LED\_Ch}$	Channel Current Accuracy	$V_{LED1} = V_{LED2} = 890mV$ , $I_{LED1} = I_{LED2} = 750mA$	-10		10	%
$Match_{LED\_Ch}$	Channel Current Matching	$V_{LED1} = V_{LED2} = 890mV$ , $I_{LED1} = I_{LED2} = 750mA$	-5		5	%
$V_{DROPOUT}$	Current Sink Dropout	Boost is in regulation		100		mV
$I_{LK\_LED1}$	LED1 Leakage Current	$V_{IN} = 3.6 V$ , $V_{EN} = 0 V$ , $V_{LED1} = 3.6 V$		0.05		$\mu A$
$I_{LK\_LED2}$	LED2 Leakage Current	$V_{IN} = 3.6 V$ , $V_{EN} = 0 V$ , $V_{LED2} = 3.6 V$		0.05		$\mu A$
$V_{FRSET}$	FRSET Pin Voltage	$R_{FRSET} = 10k\Omega$ , flash mode	<b>0.970</b>	1.00	<b>1.030</b>	V
$I_{FRSET}$	FRSET Current Sourcing	FRSET pin is shorted to ground, flash mode	<b>90</b>	100	<b>110</b>	$\mu A$
$V_{TRSET}$	TRSET Pin Voltage	$R_{TRSET} = 10k\Omega$ , torch mode	<b>0.970</b>	1.00	<b>1.030</b>	V
$I_{TRSET}$	TRSET Current Sourcing	TRSET pin is shorted to ground, torch mode	<b>90</b>	100	<b>110</b>	$\mu A$

## Electrical Characteristics<sup>(7)</sup> (Continued)

$V_{IN} = 3.6V$ ;  $L = 1\mu H$ ,  $C_{OUT} = 2.2\mu F$ ,  $R_{FRSET} = 10k\Omega$ ,  $R_{TRSET} = 10k\Omega$ ,  $I_{LED} = 100mA$ ;  $T_A = 25^\circ C$ , **bold** values indicate  $-40^\circ C \leq T_J \leq 125^\circ C$ , unless otherwise noted.

Symbol	Parameter	Condition	Min.	Typ.	Max.	Units
<b>EN / FEN / TEN / FI Control Pins</b>						
$V_{EN\_ON}$	EN On Threshold	Boost converter and chip logic ON	<b>1.5</b>			V
$V_{EN\_OFF}$	EN Off Threshold	Boost converter and chip logic ON			<b>0.4</b>	V
$V_{FEN\_ON}$	FEN On Threshold	FLASH ON	<b>1.5</b>			V
$V_{FEN\_OFF}$	FEN Off Threshold	FLASH OFF			<b>0.4</b>	V
$V_{TEN\_ON}$	TEN On Threshold	TORCH ON	<b>1.5</b>			V
$V_{TEN\_OFF}$	TEN Off Threshold	TORCH OFF			<b>0.4</b>	V
$V_{FI\_ON}$	FI On Threshold	FLASH INHIBIT ON	<b>1.5</b>			V
$V_{FI\_OFF}$	FI Off Threshold	FLASH INHIBIT OFF			<b>0.4</b>	V
	EN Pin Current	$V_{EN} = 5V$		2	5	$\mu A$
	FEN/TEN/FI Pin Current	$V_{FEN} = V_{TEN} = V_{FI} = 5V$		1	5	$\mu A$
$t_{Blank\_EN\_Off}$	EN OFF Blanking Time	EN pin should be driven low for more than this time before the IC enters sleep mode	0.90	1.10	1.30	s
<b>I<sup>2</sup>C Interface (SCL / SDA Pins) (Guaranteed by Design)</b>						
$f_{SCL}$	Maximum Operating Frequency				<b>3.4</b>	MHz
$V_{IL}$	Low-Level Input Voltage				<b>0.4</b>	V
$V_{IH}$	High-Level Input Voltage		<b>1.5</b>			V
$R_{SDA\_DN}$	SDA Pulled-Down Resistance			20		$\Omega$
<b>Additional Protection Features</b>						
$V_{TH\_LEDOPE}$	LED1 / LED2 Open Detect Threshold		15	25	40	mV
$T_{BLANK\_OPEN}$	Open Detect Blanking Time			65		$\mu s$
$T_{RETRY\_OPEN}$	Open Retry Timeout			100		ms
$V_{TH\_LEDSSH}$	Short Trigger Threshold	$V_{OUT} - \text{MAX}[V_{LED1}, V_{LED2}]$ , $V_{OUT} = 3.6V$	400	600	800	mV
$V_{HYST\_LEDSSH}$	Short Trigger Hysteresis			200		mV
$T_{BLANK\_SSH}$	Short Trigger Blanking Time			30		$\mu s$
$T_{RETRY\_SSH}$	Short Retry Timeout			100		ms

# Typical Characteristics

**Shutdown Current vs. Temperature**

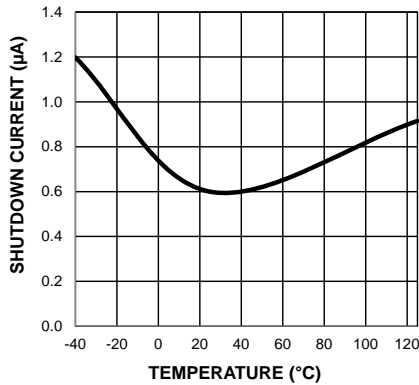

**Quiescent Current (Linear Mode) vs. Temperature**

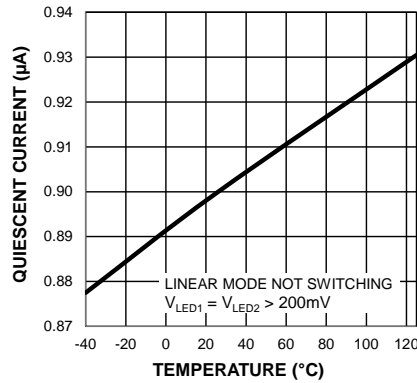

**Quiescent Current (Boost Mode) vs. Temperature**

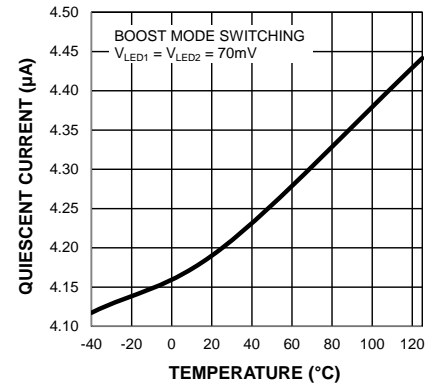

**Torch Mode LED1 and LED2 Current vs. Temperature**

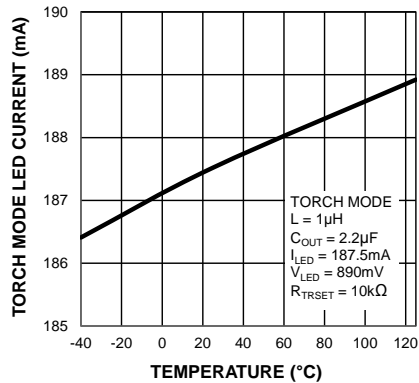

**Flash Mode LED1 and LED2 Current vs. Temperature**

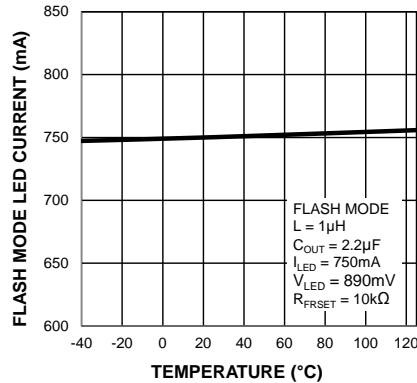

**Torch Mode  $I_{LED(MAX)}$  (Dual LEDs) vs. TRSET Resistor**

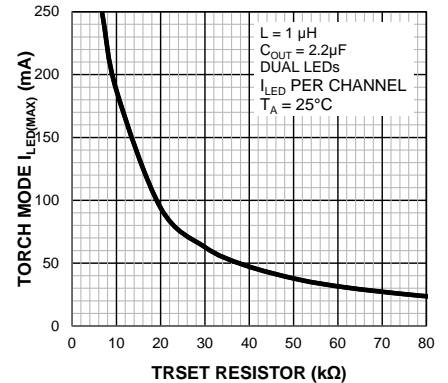

**Flash Mode  $I_{LED(MAX)}$  (Dual LEDs) vs. FRSET Resistor**

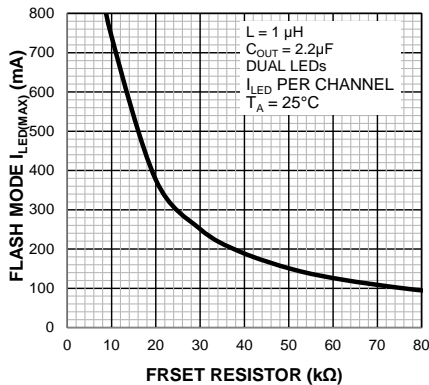

**Torch Mode  $I_{LED(MAX)}$  (Single LED) vs. TRSET Resistor**

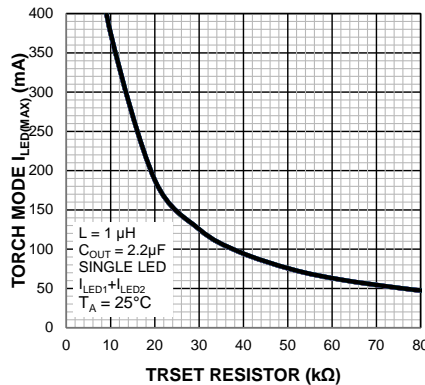

**Flash Mode  $I_{LED(MAX)}$  (Single LED) vs. FRSET Resistor**

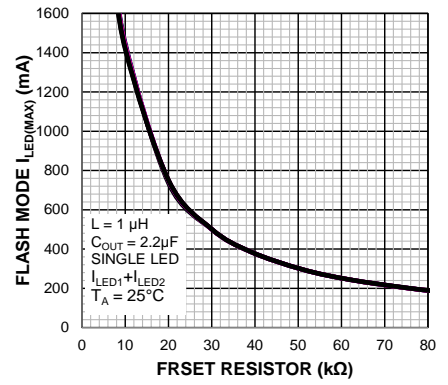

### Typical Characteristics (Continued)

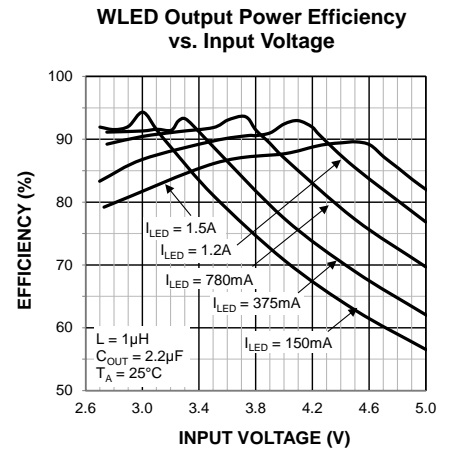
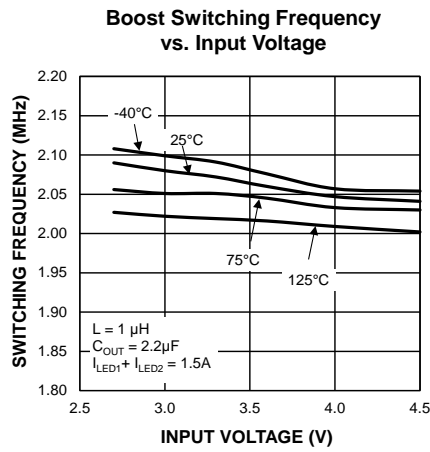
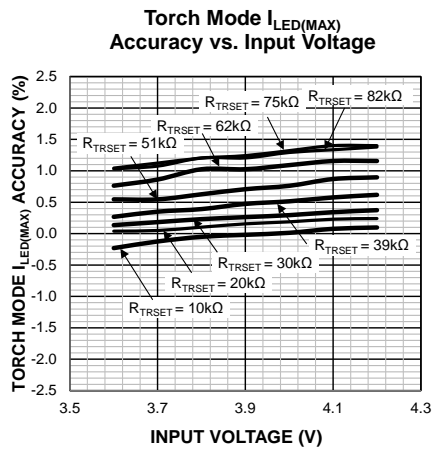



## Functional Characteristics

**Flash-Mode Turn-On Sequence  
(Boost Mode)**

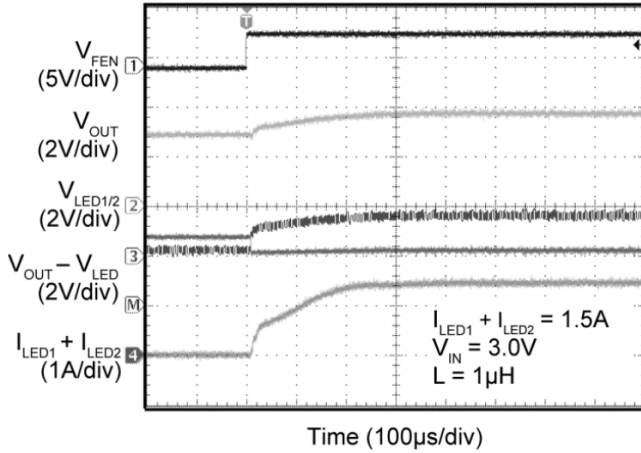

**Flash-Mode Turn-On Sequence  
(Linear Mode)**

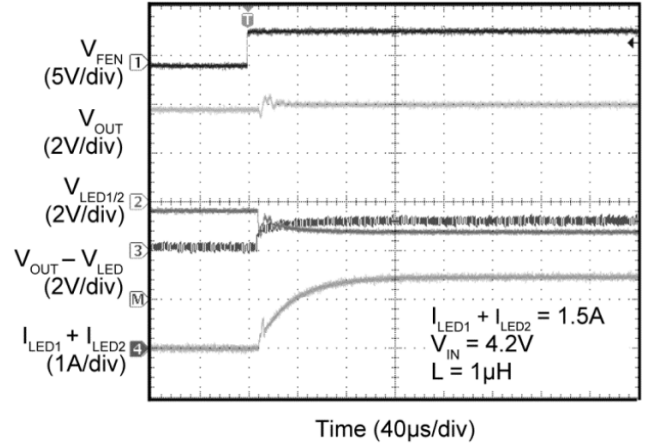

**Torch-Mode Turn-On Sequence  
(Boost Mode)**

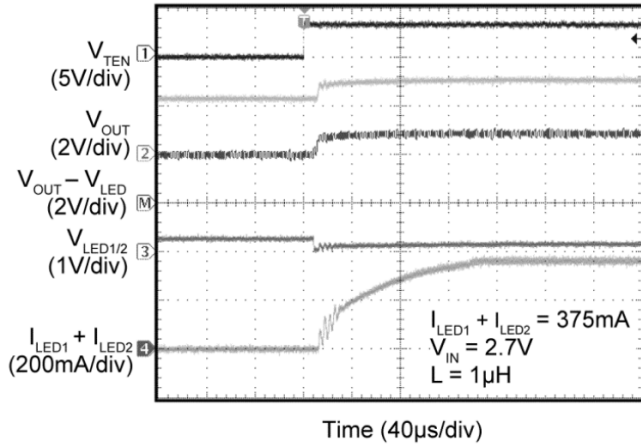

**Torch-Mode Turn-On Sequence  
(Linear Mode)**

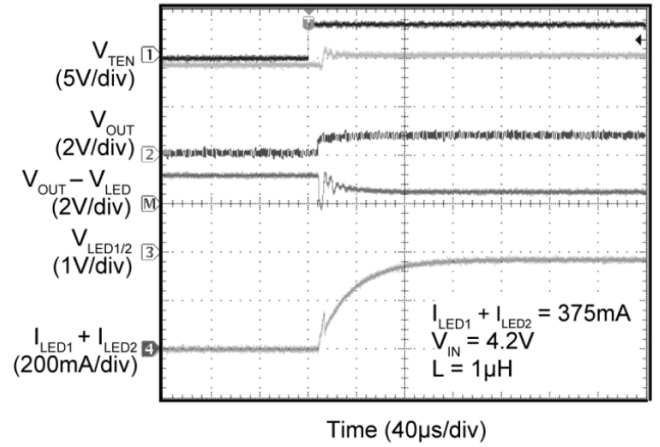

**Flash-Mode Load Disconnect  
and Enable Off Blanking Time**

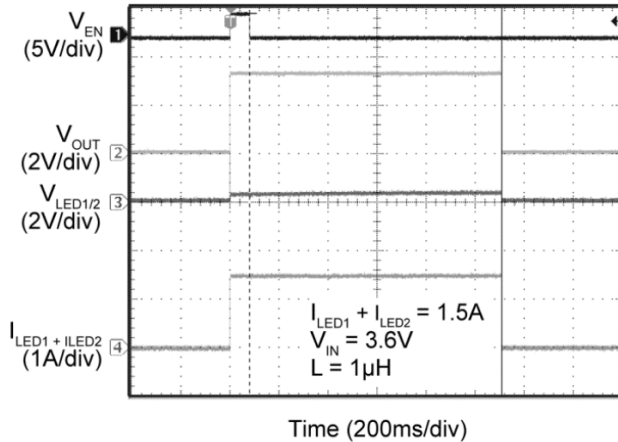

**Torch-Mode Load Disconnect  
and Enable Off Blanking Time**

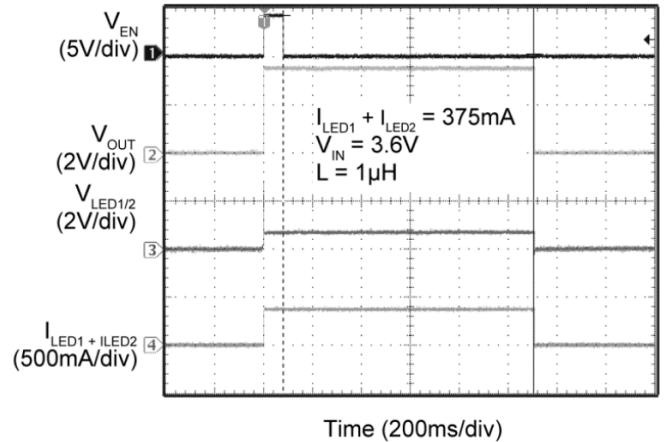

Functional Characteristics (Continued)

LED Open-Circuit Protection

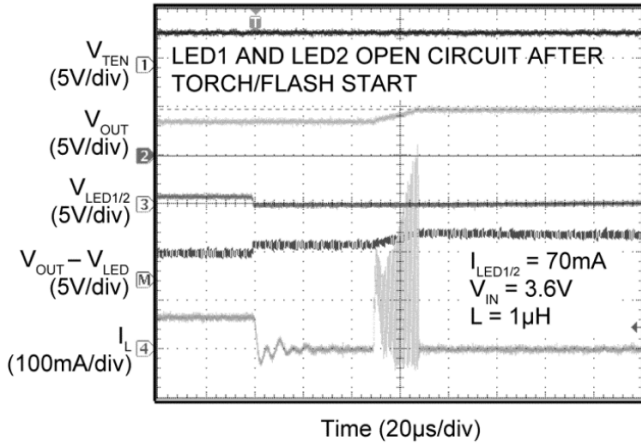

LED Open-Circuit Protection Recovery

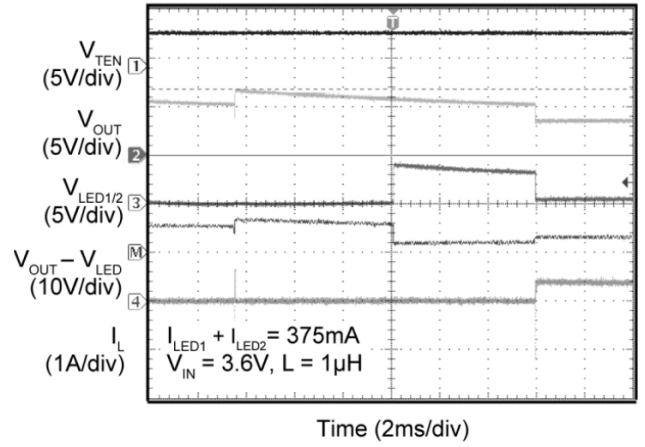

Overvoltage Protection

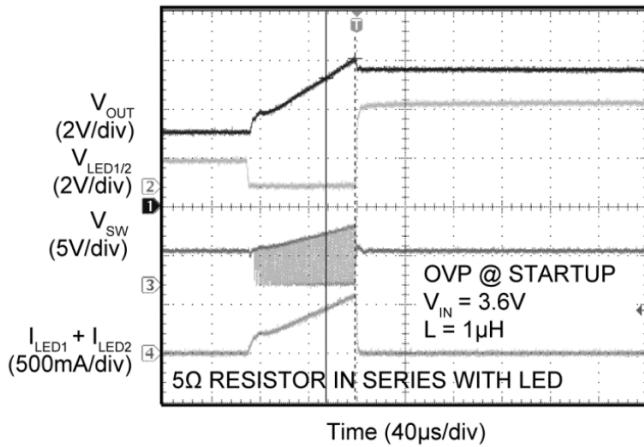

Overvoltage Protection Recovery

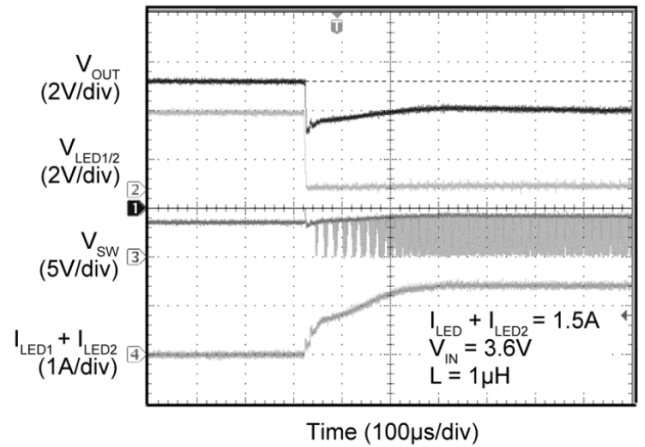

Flash Inhibit and Recovery

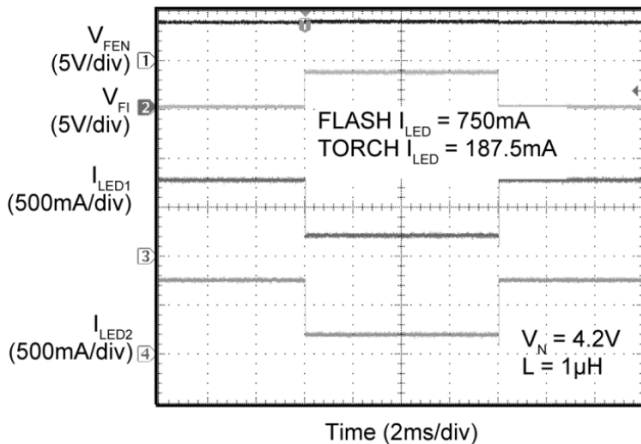

LED Short-Circuit Protection, Retry, and Recovery

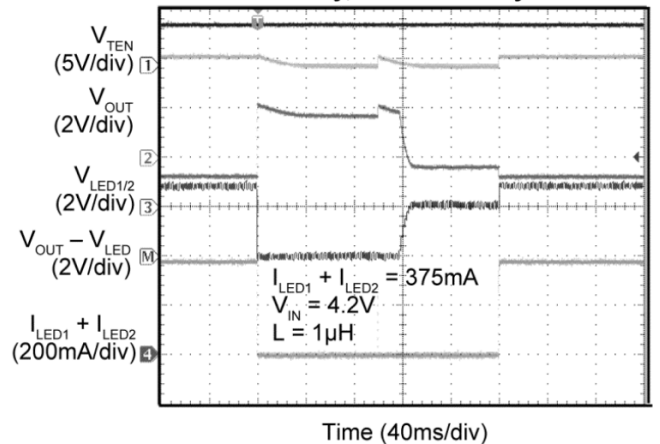

### Functional Characteristics (Continued)

Flash Safety Timer @ 1250ms

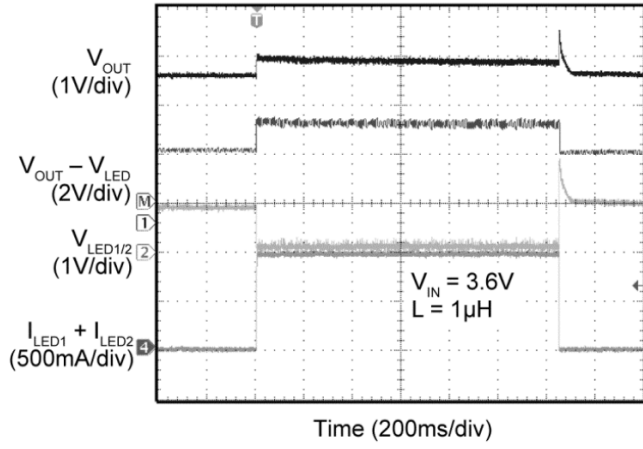

Flash Safety Timer @ 256ms

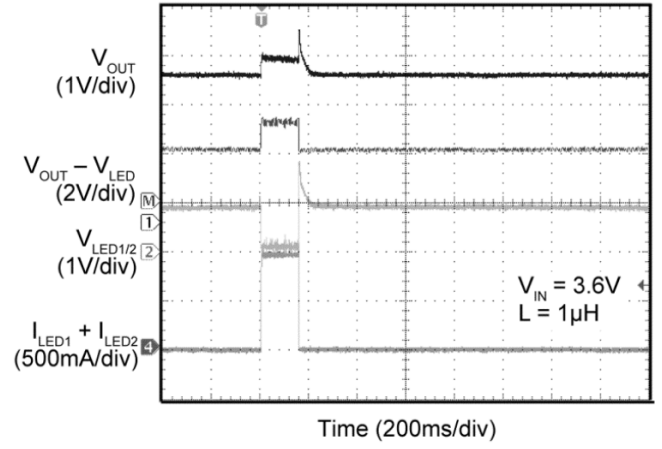

# Functional Diagram

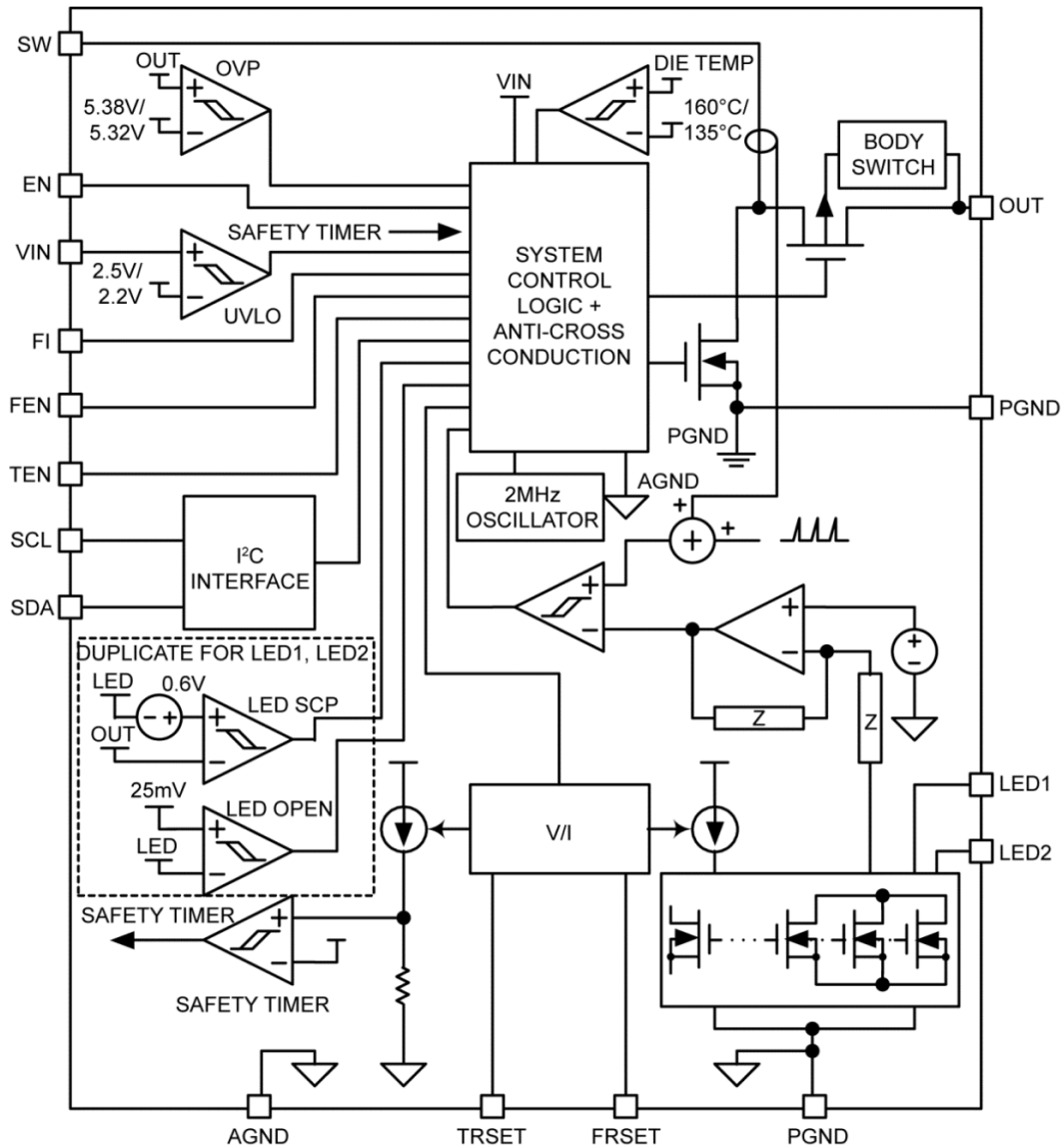

Figure 1. Simplified MIC2870 Functional Block Diagram

## Functional Description

### VIN

The input supply provides power to the internal MOSFETs gate drive and controls circuitry for the switch-mode regulator. The operating input voltage range is from 2.7V to 5.0V. A 4.7 $\mu$ F low-ESR ceramic input capacitor should be connected from VIN to AGND as close to MIC2870 as possible to ensure a clean supply voltage for the device. The minimum voltage rating of 10V is recommended for the input capacitor.

### SW

The MIC2870 has internal low-side and synchronous MOSFET switches. The switch node (SW) between the internal MOSFET switches connects directly to one end of the inductor and provides the current paths during switching cycles. The other end of the inductor is connected to the input supply voltage. Due to the high-speed switching on this pin, the switch node should be routed away from sensitive nodes wherever possible.

### AGND

This is the ground path for the internal biasing and control circuitry. The current loop of the analog ground should be separated from that of the power ground (PGND). AGND should be connected to PGND at a single point.

### PGND

The power ground pin is the ground path for the high current in the boost switch and the ground path of the LED current sinks. The current loop for the power ground should be as small as possible and separate from the AGND loop as applicable.

### OUT

Boost converter output pin which is connected to the anode of the LED. A low-ESR ceramic capacitor of 2.2 $\mu$ F or larger should be connected from OUT to PGND as close as possible to the MIC2870. The minimum voltage rating of 10V is recommended for the output capacitor.

### LED1/LED2

The current sink pins for the LED(s). The LED anode is connected to the OUT pin and the LED cathode is connected to the LED1/LED2 pin(s).

### EN

This is the enable pin of the MIC2870. The MIC2870 is in standby mode when the EN pin is asserted high. If this pin is driven low for more than 1s, the IC is shutdown. Alternatively, the I<sup>2</sup>C interface can be used for enabling/disabling the IC through the master control/status register. EN is pulled down by an internal resistor.

### FEN

FEN is the hardware enable pin for flash mode. A logic low-to-high transition on FEN pin initiates the flash mode. If FEN pin is left floating, it is pulled down internally by a built-in 1 $\mu$ A current source when the device is enabled. Flash mode is terminated when FEN is pulled low or left floating, and the flash control register is cleared.

### TEN

TEN is the hardware enable pin for torch mode. A logic low-to-high transition on TEN pin initiates the torch mode. If TEN pin is left floating, it is pulled down internally by a built-in 1 $\mu$ A current source when the device is enabled. Torch mode is terminated when TEN is pulled low or left floating, and the torch control register is cleared.

### FI

FI is the flash inhibit pin. When this pin is high in flash mode, both LED1 and LED2 currents are changed from the flash-mode current level to the torch-mode current level. When this pin is low, both LED1 and LED2 currents are changed from torch-mode current level back to the original flash-mode current level.

### FRSET

The flash-mode maximum LED current level is programmed through FRSET. A resistor connected from FRSET to AGND sets the maximum current in the flash mode. FRSET can be grounded for the default flash-mode current of 0.75A. For best current accuracy, a 0.1% tolerance resistor is recommended. FRSET cannot be left floating and the maximum resistance is limited to 80k $\Omega$ .

### TRSET

The torch-mode maximum LED current level is programmed through TRSET. A resistor connected from the TRSET pin to AGND sets the maximum current in the torch mode. TRSET can be grounded for the default torch-mode current of 187.5mA. For best current accuracy, a 0.1% tolerance resistor is recommended. TRSET cannot be left floating and the maximum resistance is limited to 80k $\Omega$ .

### SCL

I<sup>2</sup>C clock input pin provides a reference clock for clocking in the data signal. This is a high-speed mode up to 3.4MHz input pin, and requires a 4.7k $\Omega$  pull-up resistor.

### SDA

I<sup>2</sup>C data input/output pin allows for data to be written to and read from the MIC2870. This is a high-speed mode up to 3.4MHz I<sup>2</sup>C pin, and requires a 4.7k $\Omega$  pull-up resistor.

## Application Information

The MIC2870 can drive one or two high-current flash WLEDs in either flash mode or torch mode. Two WLEDs can be used to optimize the light output and beam shaping through the optical lens/reflector assembly. In this case, the two channels, up to 750mA each, are matched to within 10% for optimal flash illumination. When the two channels are combined to drive a single high-brightness WLED, the maximum current is 1.5A. If one of the channels is left floating, MIC2870 senses the circuit condition automatically and allows the other channel to operate.

### Flash Mode

The maximum current level in the flash mode is 750mA per channel. This current level can be adjusted through an external resistor connecting to FRSET according to the following equation:

$$I_{\text{LED(MAX)}} = \frac{7500}{R_{\text{FRSET}}} \quad \text{Eq. 1}$$

Alternatively, the default maximum value of 750mA per channel is used when FRSET is grounded.

The flash-mode current can be initiated at the preset FRSET brightness level by asserting FEN high or by setting the I<sup>2</sup>C flash control register (address 01h) for the desired flash duration, subjected to the flash safety timeout setting. The flash-mode current is terminated when FEN is brought low and the I<sup>2</sup>C flash register is cleared.

The flash inhibit (FI) pin can be used to synchronize the flash current to a handset GSM pulse event to prevent excessive battery droop. When FEN and FI pins are both HIGH, the flash-mode current is limited to the torch-mode current setting. The FI pin is also functional when the flash-mode current is enabled through the I<sup>2</sup>C flash register.

Flash-mode current can be adjusted to a fraction of the maximum flash-mode level (either default or set by the FRSET resistor) by selecting the desired flash current level percentage in the flash control register (address 01h) through the I<sup>2</sup>C interface. The flash current is the product of the maximum flash current setting and the percentage selected in the flash register.

The flash safety timeout feature automatically shuts down the flash current if the flash mode is enabled for an extended period of time. Refer to the flash safety timer setting in [Table 4](#).

### Torch Mode

The maximum torch-mode current level can be adjusted through an external resistor connecting to the TRSET pin according to Equation 2:

$$I_{\text{LED(MAX)}} = \frac{7500}{4R_{\text{TRSET}}} \quad \text{Eq. 2}$$

Alternatively, the default maximum value of 187.5 mA per channel is used when the TRSET pin is grounded. The torch-mode operation is activated by asserting TEN high or by setting the I<sup>2</sup>C torch register (address 02h) for the desired duration. The torch-mode current is terminated when TEN is brought low and the I<sup>2</sup>C torch register is cleared.

Like the flash-mode current, the torch-mode current can be set to a fraction of the maximum torch-mode level (either default or set by the TRSET resistor) by selecting the desired torch current level percentage in the torch register (address 02h) through the I<sup>2</sup>C interface. The torch current is the product of the maximum torch current setting and the percentage selected in the torch register.

### Overvoltage Protection

When the output voltage rises above the overvoltage protection (OVP) threshold, the MIC2870 is turned off automatically to avoid permanent damage to the IC.

### Open-Circuit Detection

The open-circuit detector (OCD) is active only when the LED current regulator is turned on. When the external LED is missing or fails open, the LED1/2 pin voltage is pulled to near the ground potential by the internal current sink. If both LEDs are open or missing, the open-circuit detector would force the boost regulator and LED current regulator to turn off. The MIC2870 will try to turn on the boost regulator and LED current regulator again after a 100ms timeout. However, in most practical cases, the boost output voltage would rise above the OVP threshold, when both LED channels have an open fault. The OVP function would cause the MIC2870 to shut down.

### Short-Circuit Detection

Like the OCD, the short-circuit detector is active only when the current regulator is turned on. If either one or both of the external LEDs fail a short, the short-circuit detector would force the MIC2870 to turn off. The MIC2870 will try to turn on the boost regulator and LED current regulator again after a 100ms timeout. If the short condition persists, the whole cycle repeats again. Prolonged operation in short-circuit condition is not recommended as it can damage the device.

## I<sup>2</sup>C Interface

Figure 2 shows the communications required for write and read operations via the I<sup>2</sup>C interface. The black lines show master communications and the red lines show the slave communications. During a write operation the master must drive SDA and SCL for all stages except the acknowledgement (A) shown in red, which are provided by the slave (MIC2870):



Figure 2. I<sup>2</sup>C Timing Example

The read operation begins firstly with a data-less write to select the register address from which to read. Then a restart sequence is issued, and then a read command followed by the data read.

The MIC2870 responds to a slave address of hex 0xB4 and 0xB5 for write and read operations respectively, or binary 1011010X (where X is the read/write bit).

The register address is eight bits wide and carries the address of the MIC2870 register to be operated upon. Only the lower three bits are used.

### I<sup>2</sup>C Registers

MIC2870 contains three 8-bit read/write registers having an address from 00h to 02h for operation control as shown in Table 1. These registers are reset to their default values in power-on-reset (POR) event. In other words, they hold their previous contents when the chip is shutdown as long as supply voltage is above 1.5V (typical).

Table 1. MIC2870 Register Map

Register Address	Register Name	Description
00h	Master Control/Status	Chip enable control and status register
01h	Flash Control	Flash-mode current, flash-mode enable, and flash timeout control register
02h	Torch Control	Torch-mode current and torch-mode enable control register

### Master Control / Status Register [00h]

The master control / status register allows the MIC2870 to be enabled by the I<sup>2</sup>C interface -- setting the ON [ ] bit high has the same effect as asserting EN pin. The LED short bit, LED\_SHT[ ] is set if any or both of the LED is shorted to OUT, while the LED open bit, LED\_OP[ ] is asserted only when both LED are open circuit. The thermal shutdown bit, TSD[ ] is set when the junction temperature of the MIC2870 is higher than 160°C.

### Flash Control Register [01h]

The flash safety timer and flash-mode current are configurable via the flash control register. Refer to flash timeout duration setting and flash-mode current setting in Table 4 and Table 5.

### Torch Control Register [02h]

The torch-mode current is configurable via the torch control register. Refer to torch-mode current setting in Table 7. The FI[ ] bit has the same function as the FI pin. When the FI[ ] bit is set, the flash-mode current is reduced to the torch-mode current setting.

**Table 2. Master Control Register [00h]**

Bit	D7	D6	D5	D4	D3	D2	D1	D0
Name	Reserved				ON	LED_SHT	LED_OP	TSD
Access	R				R/W	R		
Default Value	0							

**Table 3. Flash Control Register [01h]**

Bit	D7	D6	D5	D4	D3	D2	D1	D0
Name	FTMR			FEN	FCUR			
Access	R/W							
Default Value	111			0	0000			

**Table 4. Flash Safety Timer Setting (FTMR)**

Register Value [D7:D5] of 01h	Flash Timeout Duration (ms)
111	1250
110	1093.75
101	937.5
100	781.25
011	625
010	468.75
001	312.5
000	156.25



**Table 5. Flash-Mode Current Setting (FCUR)**

Percentage of Maximum Current / %	Register Value [D3:D0] of 01h	Current per Channel (mA) ( $R_{FRSET} = 0\Omega$ )	Combined Current (mA) ( $R_{FRSET} = 0\Omega$ )
100	0000	750.0	1500.0
90	0001	675.0	1350.0
80	0010	600.0	1200.0
70	0011	525.0	1050.0
63	0100	472.5	945.0
56	0101	420.0	840.0
50	0110	375.0	750.0
44.7	0111	335.3	670.5
39.8	1000	298.5	597.0
35.5	1001	266.3	532.5
31.6	1010	237.0	474.0
28.2	1011	211.5	423.0
25.1	1100	188.3	376.5
22.4	1101	168.0	336.0
20	1110	150.0	300.0
18	1111	135.0	270.0

**Table 6. Torch Control Register [02h]**

Bit	D7	D6	D5	D4	D3	D2	D1	D0
Name	Reserved		FI	TEN	TCUR			
Access	RO		R/W					
Default Value	0				0000			

**Table 7. Torch-Mode Current Setting (TCUR)**

Percentage of Maximum Current (%)	Register Value [D3:D0] of 02h	Current per Channel (mA) ( $R_{TRSET} = 0\Omega$ )	Combined Current (mA) ( $R_{TRSET} = 0\Omega$ )
100	0000	187.5	375.0
90	0001	168.8	337.5
80	0010	150.0	300.0
70	0011	131.3	262.5
63	0100	118.1	236.3
56	0101	105.0	210.0
50	0110	93.8	187.5
44.7	0111	83.8	167.6
39.8	1000	74.6	149.3
35.5	1001	66.6	133.1
31.6	1010	59.3	118.5
28.2	1011	52.9	105.8
25.1	1100	47.1	94.1
22.4	1101	42.0	84.0
20	1110	37.5	75.0
18	1111	33.8	67.5

## Component Selection

### Inductor

Inductor selection is a balance between efficiency, stability, cost, size, and rated current. Since the boost converter is compensated internally, the recommended inductance of L is limited from 1 $\mu$ H to 2.2 $\mu$ H to ensure system stability. It is usually a good balance between these considerations.

A large inductance value reduces the peak-to-peak inductor ripple current hence the output ripple voltage and the LED ripple current. This also reduces both the DC loss and the transition loss at the same inductor's DC resistance (DCR). However, the DCR of an inductor usually increases with the inductance in the same package size. This is due to the longer windings required for an increase in inductance. Since the majority of the input current passes through the inductor, the higher the DCR the lower the efficiency is, and more significantly at higher load currents. On the other hand, inductor with smaller DCR but the same inductance usually has a larger size. The saturation current rating of the selected inductor must be higher than the maximum peak inductor current to be encountered and should be at least 20% to 30% higher than the average inductor current at maximum output current.

### Input Capacitor

A ceramic capacitor of 4.7 $\mu$ F or larger with low ESR is recommended to reduce the input voltage ripple to ensure a clean supply voltage for the device. The input capacitor should be placed as close as possible to the MIC2870 VIN pin with short trace for good noise performance. X5R or X7R type ceramic capacitors are recommended for better tolerance over temperature. The Y5V and Z5U type temperature rating ceramic capacitors are not recommended due to their large reduction in capacitance over temperature and increased resistance at high frequencies. These reduce their ability to filter out high-frequency noise. The rated voltage of the input capacitor should be at least 20% higher than the maximum operating input voltage over the operating temperature range.

### Output Capacitor

Output capacitor selection is also a trade-off between performance, size, and cost. Increasing output capacitor will lead to an improved transient response, however, the size and cost also increase. The output capacitor is preferred in the range of 2.2 $\mu$ F to 10 $\mu$ F with ESR from 10m $\Omega$  to 50m $\Omega$ . X5R or X7R type ceramic capacitors are recommended for better tolerance over temperature.

The Y5V and Z5U type ceramic capacitors are not recommended due to their wide variation in capacitance over temperature and increased resistance at high frequencies. The rated voltage of the output capacitor should be at least 20% higher than the maximum operating output voltage over the operating temperature range.

### FRSET/TRSET Resistor

Since FRSET/TRSET resistor is used for setting the maximum LED current in flash mode and torch mode respectively, resistor type with 0.1% tolerance is recommended for more accurate LED current setting.

### Power Dissipation Consideration

As with all power devices, the ultimate current rating of the output is limited by the thermal properties of the device package and the PCB on which the device is mounted. There is a simple, Ohm's law type relationship between thermal resistance, power dissipation and temperature which are analogous to an electrical circuit:

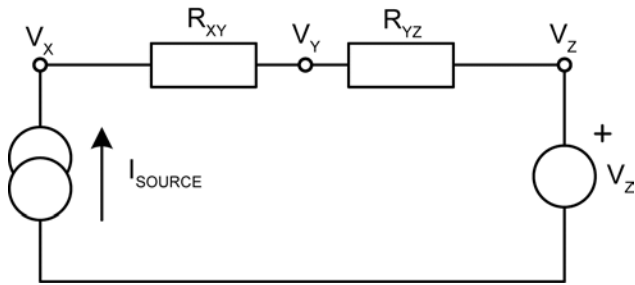

Figure 3. Series Electrical Resistance Circuit

From this simple circuit we can calculate  $V_X$  if we know  $I_{SOURCE}$ ,  $V_Z$  and the resistor values,  $R_{XY}$  and  $R_{YZ}$  using Equation 3:

$$V_X = I_{SOURCE} \times (R_{XY} + R_{YZ}) + V_Z \tag{Eq. 3}$$

Thermal circuits can be considered using this same rule and can be drawn similarly by replacing current sources with power dissipation (in watts), resistance with thermal resistance (in °C/W) and voltage sources with temperature (in °C).

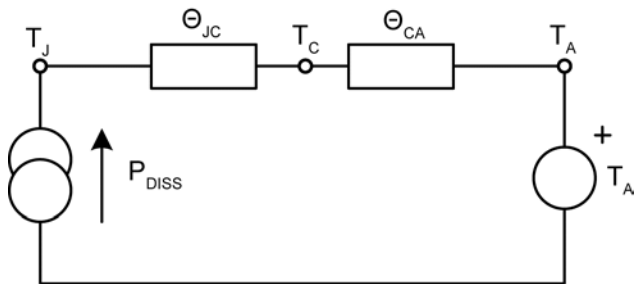

Figure 4. Series Thermal Resistance Circuit

Now replacing the variables in the equation for  $V_X$ , we can find the junction temperature ( $T_J$ ) from the power dissipation, ambient temperature and the known thermal resistance of the PCB ( $\theta_{CA}$ ) and the package ( $\theta_{JC}$ ).

$$T_J = P_{DISS} \times (\theta_{JC} + \theta_{CA}) + T_A \tag{Eq. 4}$$

As can be seen in the diagram, total thermal resistance  $\theta_{JA} = \theta_{JC} + \theta_{CA}$ . Hence this can also be written as in Equation 5:

$$T_J = P_{DISS} \times (\theta_{JA}) + T_A \tag{Eq. 5}$$

Since effectively all of the power losses (minus the inductor losses) in the converter are dissipated within the MIC2870 package,  $P_{DISS}$  can be calculated thus:

$$\text{Linear Mode: } P_{DISS} = [P_{OUT} \times \left(\frac{1}{\eta} - 1\right)] - I_{OUT}^2 \times DCR \tag{Eq. 6}$$

$$\text{Boost Mode: } P_{DISS} = [P_{OUT} \times \left(\frac{1}{\eta} - 1\right)] - \left(\frac{I_{OUT}}{1-D}\right)^2 \times DCR \tag{Eq. 7}$$

$$\text{Duty Cycle in Boost Mode: } D = \frac{V_{OUT} - V_{IN}}{V_{OUT}} \tag{Eq. 8}$$

where:

$\eta$  = Efficiency taken from efficiency curves and  $DCR$  = inductor DCR.  $\theta_{JC}$  and  $\theta_{JA}$  are found in the operating ratings section of the data sheet.

Where the real board area differs from 1" square,  $\theta_{CA}$  (the PCB thermal resistance) values for various PCB copper areas can be taken from [Figure 5](#). [Figure 5](#) is taken from [Designing with Low Dropout Voltage Regulators](#) available from the Micrel [website](#).

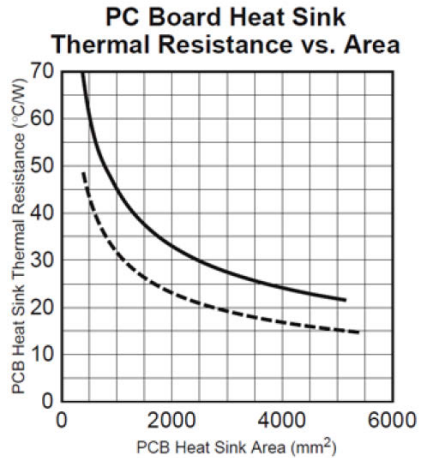

**Figure 5. Graph to Determine PC Board Area for a Given PCB Thermal Resistance**

Figure 5 shows the total area of a round or square pad, centered on the device. The solid trace represents the area of a square, single sided, horizontal, solder masked, copper PC board trace heat sink, measured in square millimeters. No airflow is assumed. The dashed line shows PC boards trace heat sink covered in black oil-based paint and with 1.3m/sec (250 feet per minute) airflow. This approaches a “best case” pad heat sink. Conservative design dictates using the solid trace data, which indicates that a maximum pad size of 5000 mm<sup>2</sup> is needed. This is a pad 71mm x 71mm (2.8 inches per side).

## PCB Layout Guidelines

PCB layout is critical to achieve reliable, stable and efficient performance. A ground plane is required to control EMI and minimize the inductance in power, signal and return paths. The following guidelines should be followed to ensure proper operation of the device:

### IC (Integrated Circuit)

- Place the IC close to the point-of-load (in this case, the flash LED).
- Use fat traces to route the input and output power lines.
- Analog ground (AGND) and power ground (PGND) should be kept separate and connected at a single location.
- The exposed pad (ePad) on the bottom of the IC must be connected to the PGND ground plane of the PCB.
- 4 to 6 thermal vias must be placed on the PCB pad for exposed pad and connected it to the PGND ground plane to ensure a good PCB thermal resistance can be achieved.

### VIN Decoupling Capacitor

- The VIN decoupling capacitor must be placed close to the VIN pin of the IC and preferably connected directly to the pin and not through any via. The capacitor must be located right at the IC.
- The VIN decoupling capacitor should be connected to analog ground (AGND).
- The VIN terminal is noise sensitive and the placement of capacitor is very critical.

### Inductor

- Keep both the inductor connections to the switch node (SW) and input power line short and wide enough to handle the switching current. Keep the areas of the switching current loops small to minimize the EMI problem.
- Do not route any digital lines underneath or close to the inductor.
- Keep the switch node (SW) away from the noise sensitive pins.
- To minimize noise, place a ground plane underneath the inductor.

### Output Capacitor

- Use wide and short traces to connect the output capacitor to the OUT and PGND pins.
- Place several vias to the ground plane close to the output capacitor ground terminal.
- Use either X5R or X7R temperature rating ceramic capacitors. Do not use Y5V or Z5U type ceramic capacitors.

### Flash LED

- Use wide and short trace to connect the LED anode to the OUT pin.
- Use wide and short trace to connect the LED cathode to the LED1/LED2 pins.
- Make sure that the LED's PCB land pattern can provide sufficient PCB pad heat sink to the flash LED.

### FRSET/TRSET Resistor

- The FRSET/TRSET resistor should be placed close to the FRSET/TRSET pin and connected to AGND.

## Typical Application Schematic

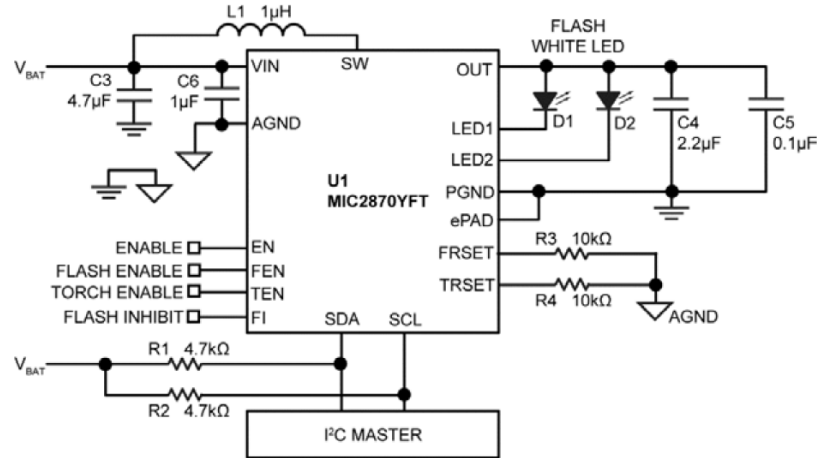

## Bill of Materials

Item	Part Number	Manufacturer	Description	Qty.
C3	0603ZD475KAT2A	AVX <sup>(8)</sup>	Ceramic Capacitor 4.7µF, 10V, X5R, 0603	1
	C1608X5R1A475K080AC	TDK <sup>(9)</sup>		
C4	0603ZD225KAT2A	AVX	Ceramic Capacitor 2.2µF, 10V, X5R, 0603	1
	GRM188R61A225KE34D	Murata <sup>(10)</sup>		
	C1608X5R1A225K080AC	TDK		
C5	06033D104KAJ2A	AVX	Ceramic Capacitor 0.1µF, 25V, X5R, 0603	1
	GRM188R61C104KA01D	Murata		
	C1608X5R1E104K	TDK		
C6	0603ZD105KAT2A	AVX	Ceramic Capacitor 1µF, 10V, X5R, 0603	1
	GRM188R61A105KA61D	Murata		
	C1608X5R1A105K080AC	TDK		
L1	CDRH4D28CLDNP-1R0PC	Sumida <sup>(11)</sup>	Inductor 1µH, 3.0A, 14mΩ, L5.1mm × W5.1mm × H3.0mm	1
	LQH44PN1R0NP0L	Murata	Inductor 1µH, 2.45A, 36mΩ, L4.0mm × W4.0mm × H1.65mm	
R1, R2	CRCW06034K70FKEA	Vishay/Dale <sup>(12)</sup>	Resistor 4.7kΩ, 1%, 1/10W, 0603	2
R3, R4	ERA3AEB103V	Panasonic <sup>(13)</sup>	Resistor 10kΩ, 0.1%, 1/10W, 0603	2
D1, D2	SML-LXL99UWC-TR/5	Lumex <sup>(14)</sup>	LED SQ 5W COOL WHT 6000K SMD, 190lm	2
U1	<b>MIC2870YFT</b>	<b>Micrel, Inc.</b> <sup>(15)</sup>	<b>1.5A Synchronous Boost Flash LED Driver with I<sup>2</sup>C Interface</b>	1

### Notes:

8. AVX: [www.avx.com](http://www.avx.com).
9. TDK: [www.tdk.com](http://www.tdk.com).
10. Murata: [www.murata.com](http://www.murata.com).
11. Sumida: [www.sumida.com](http://www.sumida.com).
12. Vishay: [www.vishay.com](http://www.vishay.com).
13. Panasonic: [www.panasonic.com](http://www.panasonic.com).
14. Lumex: [www.lumex.com](http://www.lumex.com).
15. Micrel, Inc.: [www.micrel.com](http://www.micrel.com).





Package Information<sup>(16)</sup>

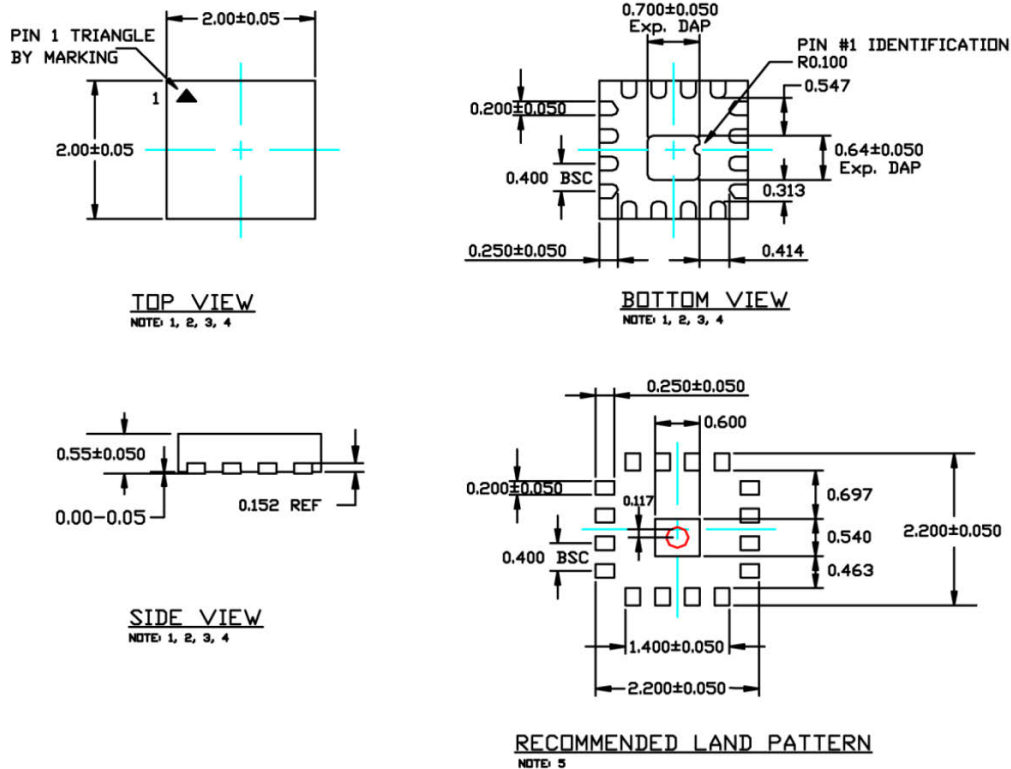

- NOTE:
1. ALL DIMENSION ARE IN MILLIMETERS
  2. MAX PACKAGE WARPAGE IS 0.08 MM
  3. MAX ALLOWABLE BURR IS 0.076MM IN ALL DIRECTIONS
  4. PIN #1 ID WILL BE LASER MARKED
  5. RED CIRCLE INDICATES THERMAL VIA. SIZE SHOULD BE 0.300MM IN DIAMETER AND SHOULD BE CONNECTED TO GROUND PLANE FOR MAXIMUM THERMAL PERFORMANCE.

16-Pin 2mm x 2mm TQFN (FT)

Note:

16. Package information is correct as of the publication date. For updates and most current information, go to [www.micrel.com](http://www.micrel.com).

**MICREL, INC. 2180 FORTUNE DRIVE SAN JOSE, CA 95131 USA**  
 TEL +1 (408) 944-0800 FAX +1 (408) 474-1000 WEB <http://www.micrel.com>

Micrel makes no representations or warranties with respect to the accuracy or completeness of the information furnished in this data sheet. This information is not intended as a warranty and Micrel does not assume responsibility for its use. Micrel reserves the right to change circuitry, specifications and descriptions at any time without notice. No license, whether express, implied, arising by estoppel or otherwise, to any intellectual property rights is granted by this document. Except as provided in Micrel's terms and conditions of sale for such products, Micrel assumes no liability whatsoever, and Micrel disclaims any express or implied warranty relating to the sale and/or use of Micrel products including liability or warranties relating to fitness for a particular purpose, merchantability, or infringement of any patent, copyright or other intellectual property right.

Micrel Products are not designed or authorized for use as components in life support appliances, devices or systems where malfunction of a product can reasonably be expected to result in personal injury. Life support devices or systems are devices or systems that (a) are intended for surgical implant into the body or (b) support or sustain life, and whose failure to perform can be reasonably expected to result in a significant injury to the user. A Purchaser's use or sale of Micrel Products for use in life support appliances, devices or systems is a Purchaser's own risk and Purchaser agrees to fully indemnify Micrel for any damages resulting from such use or sale.

© 2013 Micrel, Incorporated.