

PACKAGE DIMENSIONS

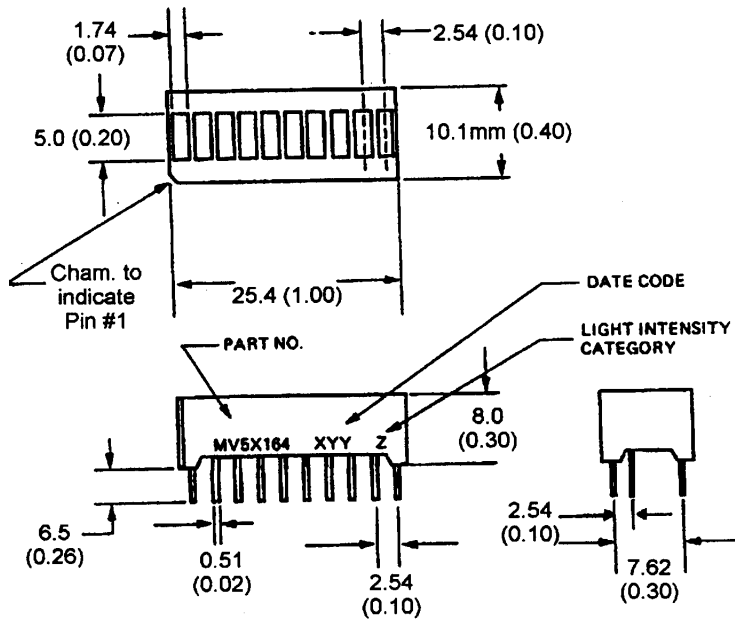

NOTE: Dimensions are in mm (inch).
Tolerances are ± 0.25 (0.1) unless otherwise noted.
All pins are 0.5 (.02).

FEATURES

- Large segments, closely spaced
- End stackable
- Fast switching - excellent for multiplexing
- Low power consumption
- Directly compatible with ICs
- Wide viewing angle
- 0.1 inch pin to pin spacing
- Individual LED chip addressable
- Dual function

APPLICATIONS

- Analog instrument displays
- Level

MODEL NUMBER

<u>Part Number</u>	<u>Colour</u>	<u>Description</u>
MV59164	HER Red/Green	Individual LED addressable

(For other color options, contact your local area Sales Office)

ABSOLUTE MAXIMUM RATING ($T_A = 25^\circ\text{C}$ unless otherwise specified)

	HER	Green	Units
Peak forward current per segment (Duty cycle 1/10, 10KHz)	90	90	mA
Continuous IF per segment	25	25	mA
Power dissipation per segment	70*	70	mW
*Derate linearly from 25°C	0.33	0.33	mW/°C
Reverse voltage VR per segment	5	5	Volts
Operating and storage temperature range.....	-25°C to +85°C		
Soldering time at 260°C..... (1/16" below seating plane)	3 sec		

ELECTRO - OPTICAL CHARACTERISTICS ($T_A = 25^\circ\text{C}$ unless otherwise specified)

	HER	Green	Test Condition
Luminous Intensity/Dot Digit average (Typical)	3000ucd	3000ucd	$I_F = 20\text{mA}$
Forward voltage (V_F) typical	2.0V	2.1V	$I_F = 20\text{mA}$
maximum	2.8V	2.8V	$I_F = 20\text{mA}$
Peak wavelength (nm)	635nm	570nm	$I_F = 20\text{mA}$
Spectral line half width (nm)	45nm	30nm	$I_F = 20\text{mA}$
Reverse breakdown voltage V_R	5V	5V	$I_R = 100\mu\text{A}$

PIN CONNECTION / SCHEMATIC:

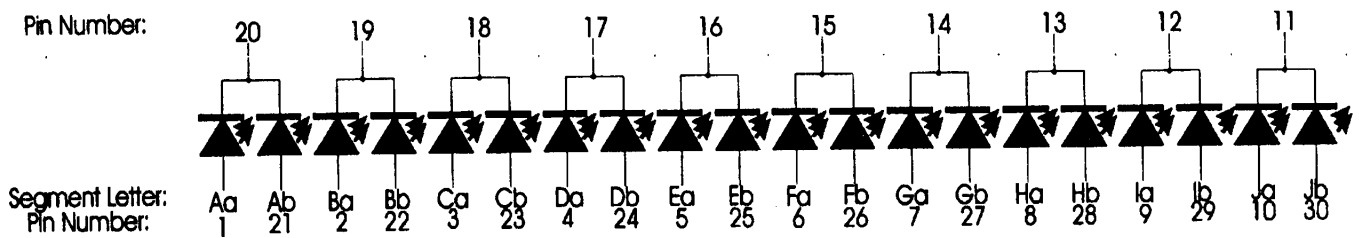
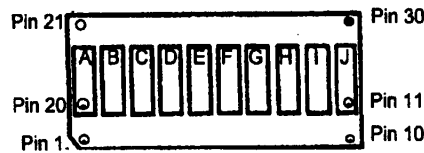

Note: **a = Red LED**
 b = Green LED

GRAPHICAL DETAIL: High Efficiency Red ($T_A = 25^\circ\text{C}$ unless otherwise specified)

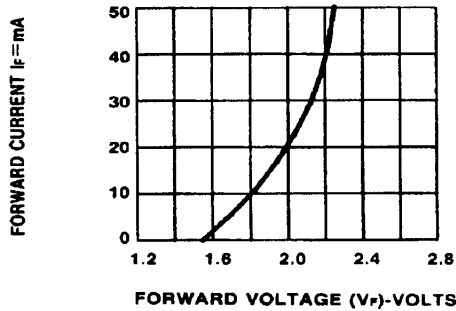

Fig.1 FORWARD CURRENT VS. FORWARD VOLTAGE.

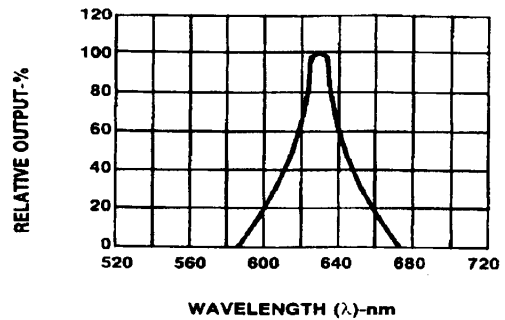

Fig.2 SPECTRAL RESPONSE

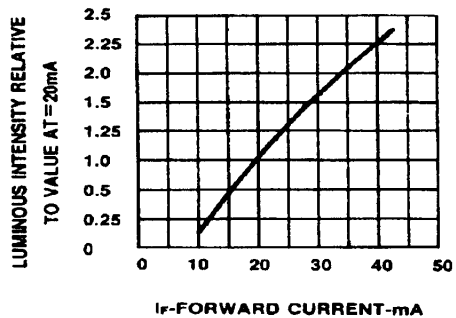

Fig.3 RELATIVE LUMINOUS INTENSITY VS. FORWARD CURRENT

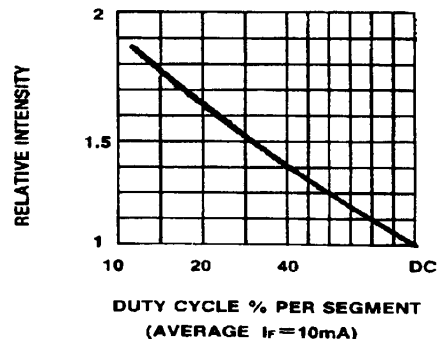

Fig.5 LUMINOUS INTENSITY VS. DUTY CYCLE

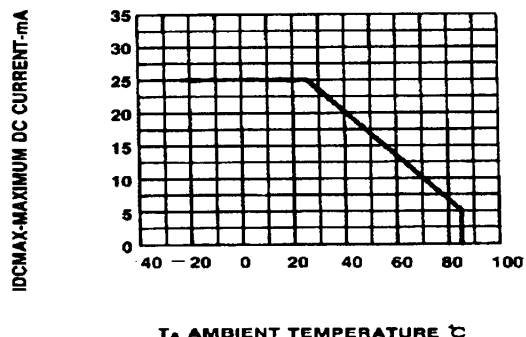

Fig.4 MAXIMUM ALLOWABLE DC CURRENT PER SEGMENT VS. A FUNCTION OF AMBIENT TEMPERATURE.

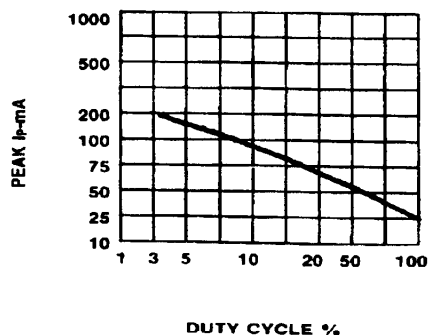

Fig.6 MAX PEAK CURRENT VS. DUTY CYCLE % (REFRESH RATE $f = 1 \text{ kHz}$)

GRAPHICAL DETAIL: Green ($T_A = 25^\circ\text{C}$ unless otherwise specified)

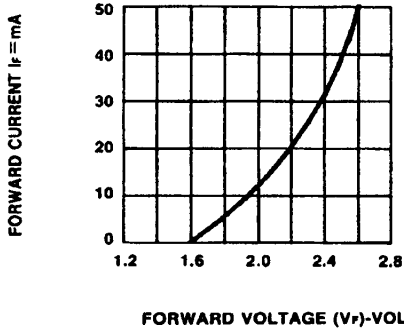

Fig.1 FORWARD CURRENT VS. FORWARD VOLTAGE.

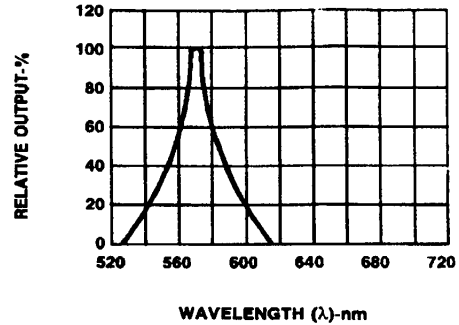

Fig.2 SPECTRAL RESPONSE

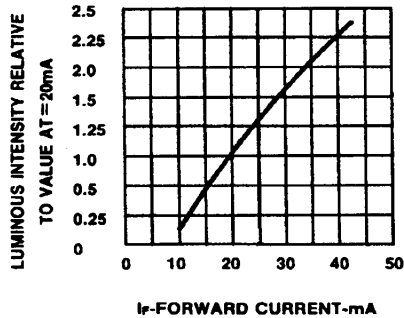

Fig.3 RELATIVE LUMINOUS INTENSITY VS. FORWARD CURRENT

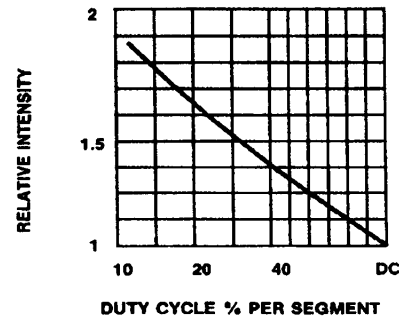

Fig.5 LUMINOUS INTENSITY VS. DUTY CYCLE

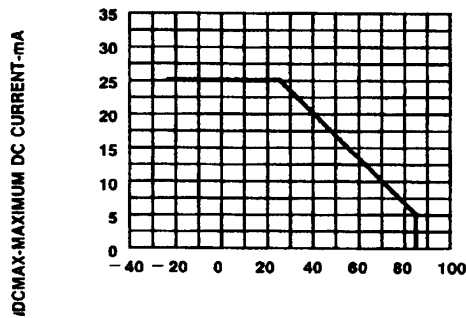

Fig.4 MAXIMUM ALLOWABLE DC CURRENT PER SEGMENT CS. A FUNCTION OF AMBIENT TEMPERATURE.

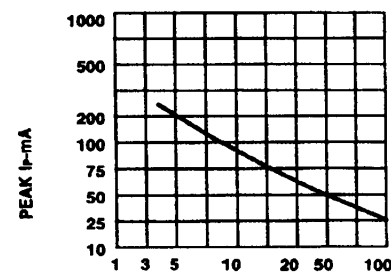

Fig.6 MAX PEAK CURRENT VS. DUTY CYCLE % (REFRESH RATE $f = 1\text{ KHz}$)

DISCLAIMER

FAIRCHILD SEMICONDUCTOR RESERVES THE RIGHT TO MAKE CHANGES WITHOUT FURTHER NOTICE TO ANY PRODUCTS HEREIN TO IMPROVE RELIABILITY, FUNCTION OR DESIGN. FAIRCHILD DOES NOT ASSUME ANY LIABILITY ARISING OUT OF THE APPLICATION OR USE OF ANY PRODUCT OR CIRCUIT DESCRIBED HEREIN; NEITHER DOES IT CONVEY ANY LICENSE UNDER ITS PATENT RIGHTS, NOR THE RIGHTS OF OTHERS.

LIFE SUPPORT POLICY

FAIRCHILD'S PRODUCTS ARE NOT AUTHORIZED FOR USE AS CRITICAL COMPONENTS IN LIFE SUPPORT DEVICES OR SYSTEMS WITHOUT THE EXPRESS WRITTEN APPROVAL OF THE PRESIDENT OF FAIRCHILD SEMICONDUCTOR CORPORATION. As used herein:

1. Life support devices or systems are devices or systems which, (a) are intended for surgical implant into the body, or (b) support or sustain life, and (c) whose failure to perform when properly used in accordance with instructions for use provided in the labeling, can be reasonably expected to result in a significant injury of the user.
2. A critical component in any component of a life support device or system whose failure to perform can be reasonably expected to cause the failure of the life support device or system, or to affect its safety or effectiveness.