

Product Data Sheet 3214 J/2H4P

ebmpapst

Die Wahl der Ingenieure



3214 J/2H4P

INDEX

1	General	3
2	Mechanics	3
2.1	General	3
2.2	Connections	3
3	Operating Data	4
3.1	Operating Data - Electrical Interface - Input	4
3.2	Electrical Operating Data	5
3.3	Operating Data - Electrical Interface -Output	6
3.4	Electrical Features	7
3.5	Aerodynamic	8
3.6	Sound Data	9
4	Environment	9
4.1	General	9
4.2	Climatic requirements*)	9
5	Safety	10
5.1	Electrical Safety	10
5.2	Approval Tests	10
6	Reliability	10
6.1	General	10

1 General

Fan type	Fan	
Rotational direction looking at rotor	clockwise	
Airflow direction	Air outlet over struts	
Bearing system	Ball bearing	
Mounting position	any	

2 Mechanics

2.1 General

Width	92,0 mm	
Height	92,0 mm	
Depth	38,0 mm	
Weight	0,290 kg	
Housing material	Plastic	
Impeller material	Plastic	
Max. torque when mounted across both mounting flanges	wire outlet corner: 30 Ncm remaining corners: 30 Ncm	
Screw size	ISO 4762 - M4 degreased, without an additional brace and without washer	

2.2 Connections

Electrical connection	Wires	
Length of lead wire	L = 310 mm	
Tolerance	+ - 10,0 mm	
Wire gauge (AWG)	22	
Insulation diameter	1,30 mm	
Contact	see drawing	

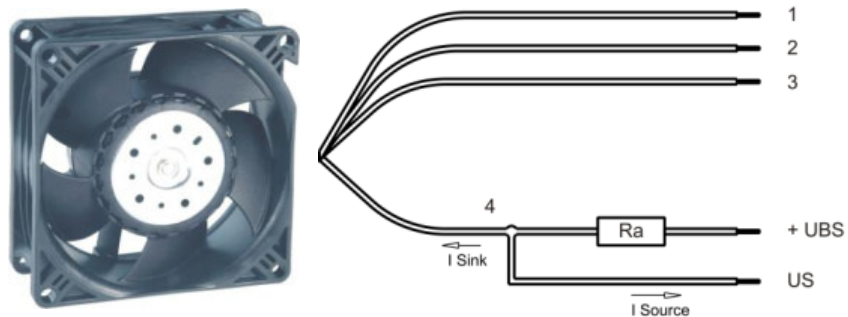

	Colour	Operation
Wire 1	red	+ UB
Wire 2	blue	- GND
Wire 3	violet	PWM
Wire 4	white	Tacho

The auxiliaries shown on the schematic diagram (which are required for the intended use) are not part of our delivery.

3 Operating Data

3.1 Operating Data - Electrical Interface - Input

Control input	PWM
---------------	-----

Features

Input type	Open collector	
PWM - Frequency		1 kHz - 5 kHz

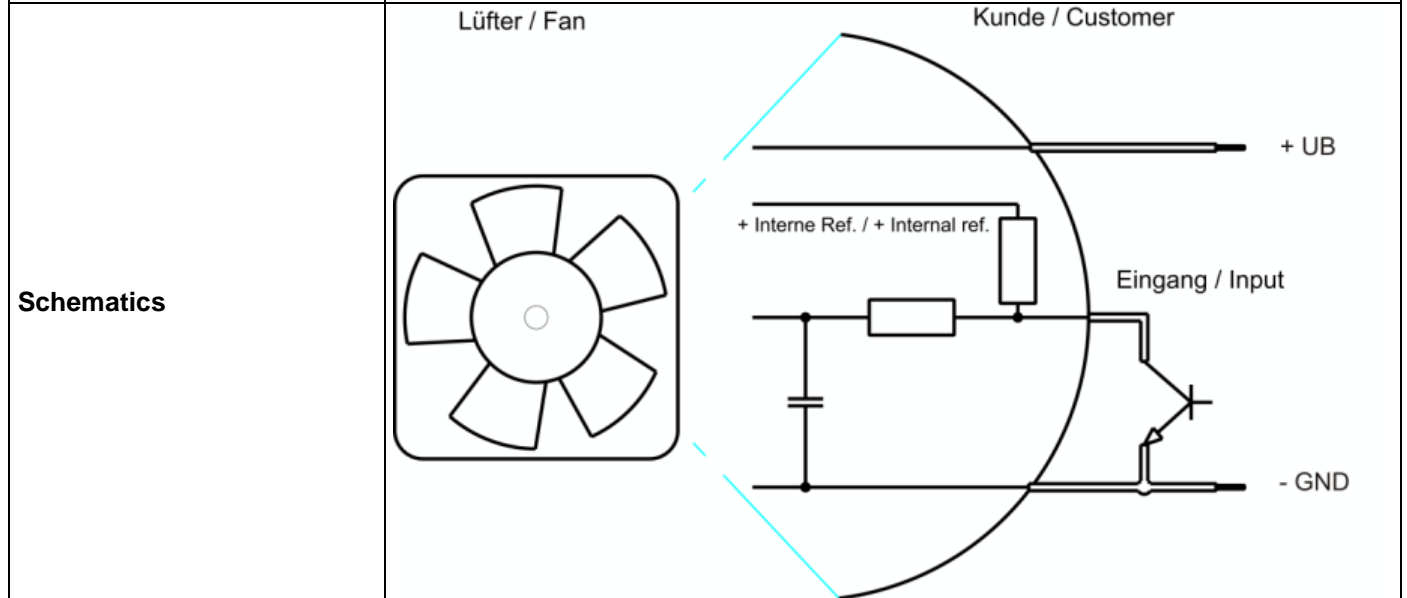
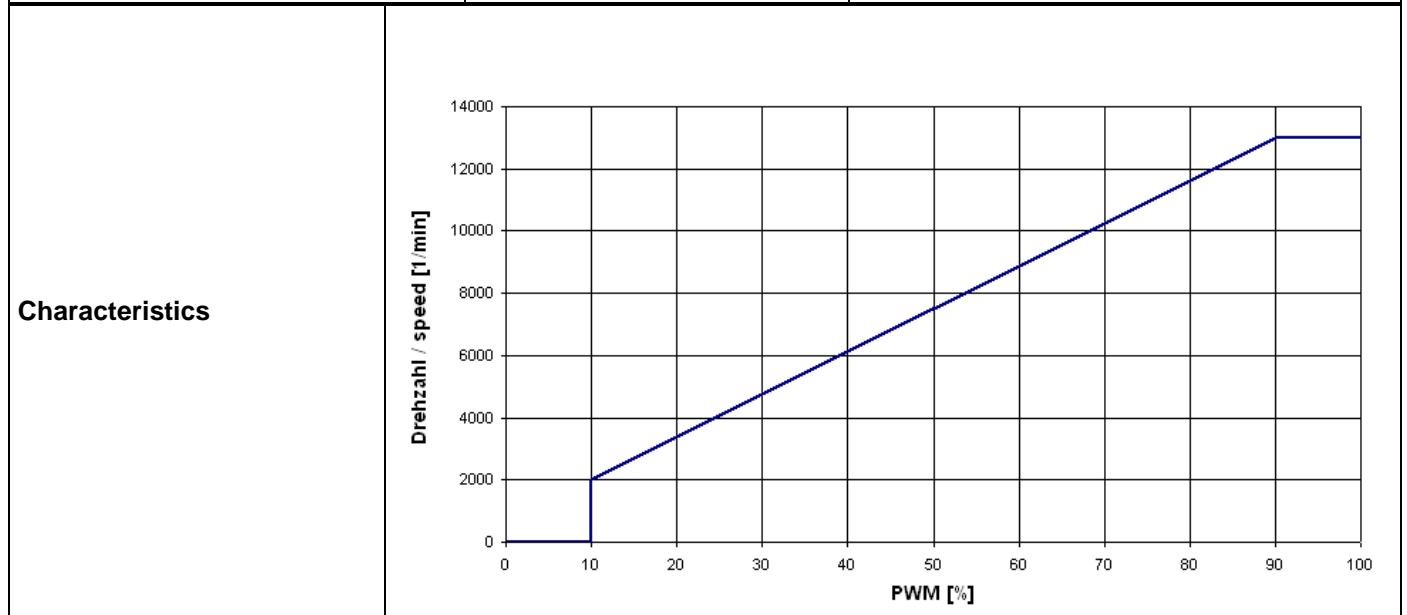

Speed control: 0...100 % PWM; f: 1...5 kHz; open collector PWM-Low <0,2 V

3.2 Electrical Operating Data

Measurement conditions: Normal air density = 1,2 kg/m³; Temperature 23°C +/- 3°C; Motor axis horizontal; warm-up time before measuring 5 minutes (unless otherwise specified). In the intake and outlet area should not be any solid obstruction within 0,5 m.

$\Delta p = 0$: corresp. to free air flow (see section 3.5)
 I: corresp. to arithm. mean current value

Name	Condition		
PWM 0001	PWM: 100 %;	f: 1 kHz	f: 5 kHz

Features	Condition	Symbol	Values		
Voltage range	$\Delta p = 0$	U	12,0 V		27,6 V
Nominal voltage	$\Delta p = 0$	U_N		24,0 V	
Power consumption	$\Delta p = 0$	P	12,0 W	50,0 W	50,0 W
Tolerance	PWM 0001		+/- 17,5 %	+/- 17,5 %	+/- 25,0 %
Current consumption	$\Delta p = 0$	I	1.000 mA	2.000 mA	1.800 mA
Tolerance	PWM 0001		+/- 17,5 %	+/- 17,5 %	+/- 25,0 %
Speed	$\Delta p = 0$	n	7.800 1/min	13.000 1/min	13.000 1/min
Tolerance	PWM 0001		+/- 12,5 %	+/- 7,5 %	+/- 3,0 %
Starting current consumption				6.500 mA	
Inrush current				34.000 mA	

Name	Condition		
PWM 0002	PWM: 50 %;	f: 1 kHz	f: 5 kHz

Features	Condition	Symbol	Values		
Voltage range	$\Delta p = 0$	U	12,0 V		27,6 V
Nominal voltage	$\Delta p = 0$	U_N		24,0 V	
Power consumption	$\Delta p = 0$	P	10,4 W	12,0 W	12,0 W
Tolerance	PWM 0002		+/- 17,5 %	+/- 25,0 %	+/- 25,0 %
Current consumption	$\Delta p = 0$	I	870 mA	500 mA	435 mA
Tolerance	PWM 0002		+/- 17,5 %	+/- 25,0 %	+/- 25,0 %
Speed	$\Delta p = 0$	n	7.350 1/min	7.500 1/min	7.500 1/min
Tolerance	PWM 0002		+/- 12,5 %	+/- 5,0 %	+/- 5,0 %

3.3 Operating Data - Electrical Interface -Output

Tacho type	/2 (Open collector)
------------	---------------------

Signal-Ausgangsspannung / Signal output voltage

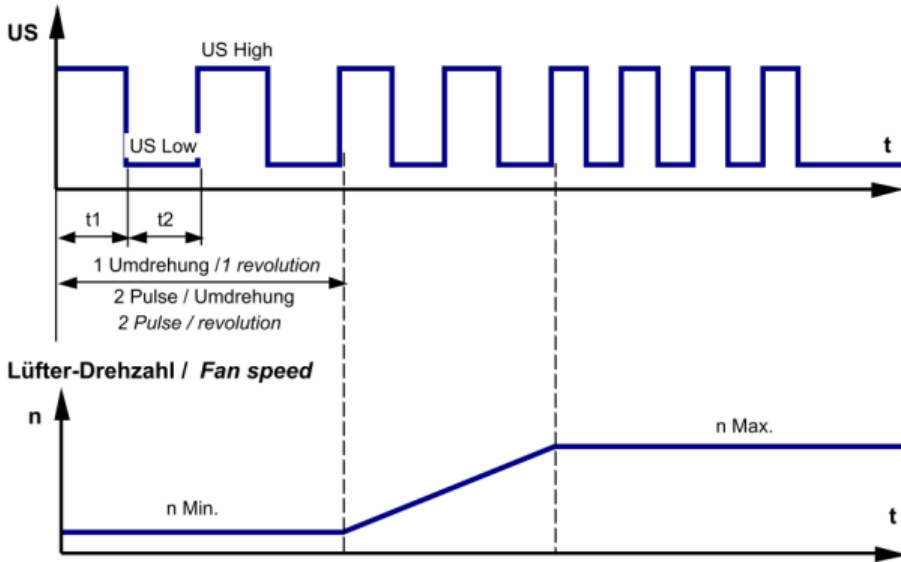

$$R_a = \frac{U_{BS} - US_{Low}}{I_{Sink}}$$

Features	Note	Values
Tacho operating voltage (UBS)		<= 60 V
Tacho signal Low	I sink: 2 mA	<= 0,4 V
Tacho signal High	I source: 0 mA	<= 60 V
Maximum sink current		<= 4 mA
External resistor	External resistor Ra from UBS to US required. All voltages measured to GND.	
Tacho frequency	(2 x n) / 60	
Tacho isolated from motor	No	
Slew rate		=> 0,5 V/us

Alarm type	None
------------	------

3.4 Electrical Features

Electronic function	Speed-Controlled	
Reversed polarity protection	Rectifying diode	
Max. residual current at U_n	$I_F \leq 300 \mu A$	
Locked rotor protection	Auto restart	
Locked rotor current at U_n	approx. 6.500 mA	
Clock signal t_3/t_4 at locked rotor	Typical: 0,5 s / 10 s	

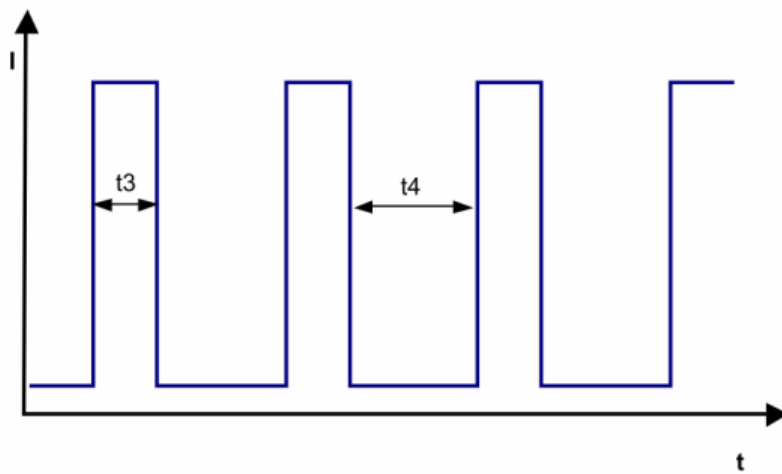

3.5 Aerodynamic

Measurement conditions: Measured with a double chamber intake rig acc. to DIN EN ISO 5801. Normal air density = 1,2 kg/m³; Temperature 23°C +/- 3°C; In the intake and outlet area should not be any solid obstruction within 0,5 m. The information is only valid under the specified test conditions and may be changed by the installation conditions. If there are deviations from the standard test conditions, the characteristic values must be checked under the installed conditions.

a.) Operation condition:

13.000 1/min at free air flow	PWM 100 %;	f: 1 kHz	f: 5 kHz
-------------------------------	------------	----------	----------

Max. free-air flow ($\Delta p = 0 / \dot{V} = \text{max.}$)	285,0 m ³ /h
Max. static pressure ($\Delta p = \text{max.} / \dot{V} = 0$)	800 Pa

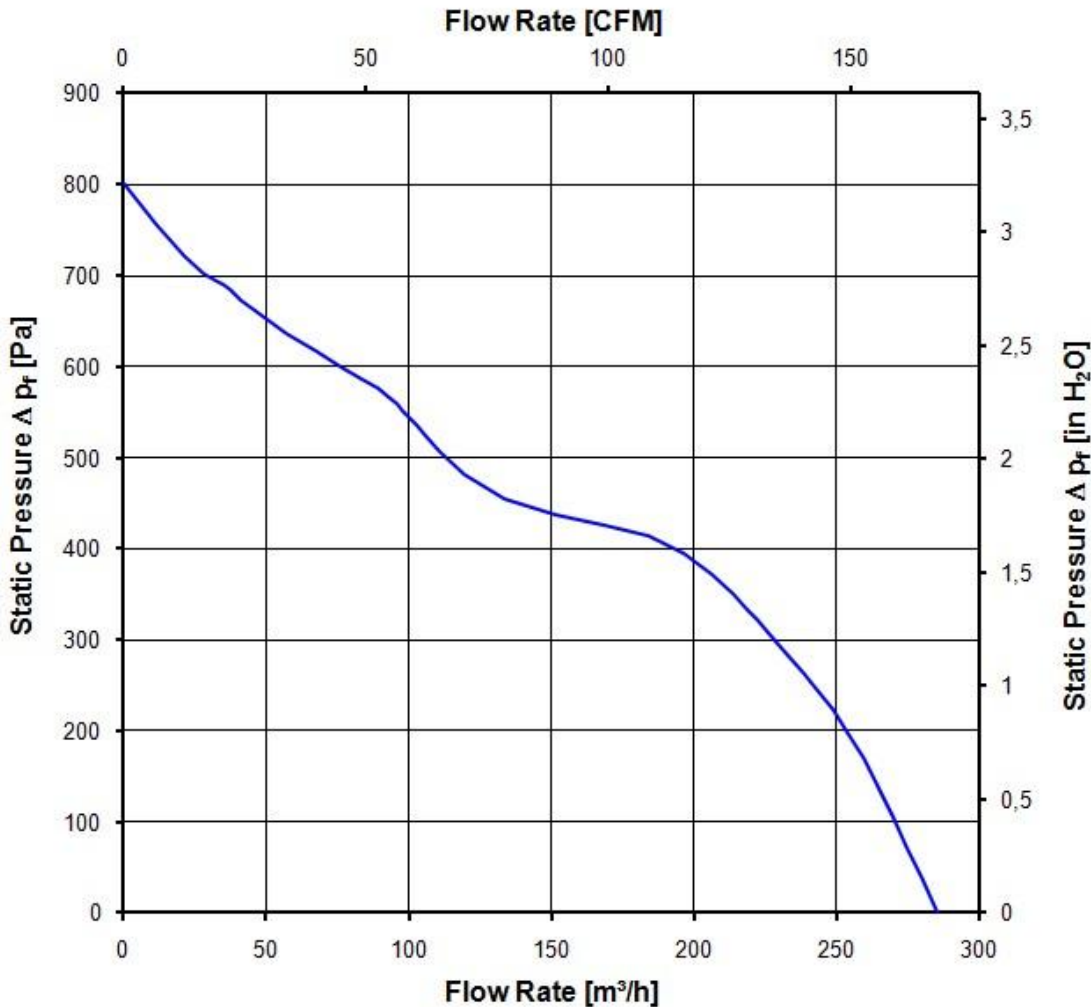

3.6 Sound Data

Measurement conditions: Sound pressure level: 1 Meter distance between microphone and the air intake.
 Sound power level: Acc. to DIN 45635 part 38 (ISO 10302)
 Measured in a semianchoic chamber with a background noise level of $L_p(A) < 5 \text{ dB(A)}$
 For further measurement conditions see section 3.5

a.) Operation condition:

13.000 1/min at free air flow	PWM 100 %	PWM min.: ; f: 1 kHz	PWM max.;; f: 5 kHz
-------------------------------	-----------	----------------------	---------------------

Optimal operating point	190,0 m ³ /h @ 374 Pa	
Sound power level at the optimal operating point	8,0 bel(A)	
Sound pressure level at free air flow, measured in rubber bands	76,0 dB(A)	

4 Environment

4.1 General

Min. permitted ambient temperature TU min.	-20 °C	
Max. permitted ambient temperature TU max.	70 °C	
Min. permitted storage temperature TL min.	-40 °C	
Max. permitted storage temperature TL max.	80 °C	

4.2 Climatic requirements *)

Humidity requirements	humid heat, constant; according to DIN EN 60068-2-78, 14 days	
Water exposure	None	
Dust requirements	None	
Salt fog requirements	None	

*) Permitted application area:

The product is intended for use in sheltered rooms with controlled temperature and controlled humidity. Directly exposure to water must be avoided.

Pollution degree 1 (according DIN EN 60664-1)

There is either no pollution or it occurs only dry, non-conductive pollution. The pollution has no negative impact. Please require severity levels and specification parameters from the responsible development departments

5 Safety

5.1 Electrical Safety

Dielectric strength DIN EN 60950 (VDE 0805) and DIN EN 60335 (VDE 0700) A.) Type test Measuring conditions: After 48h of storage at 95% R.H. and 25°C. No arcing or breakdown is allowed! All connections together to ground.	500 VAC / 1 Min.	
B.) Routine test Measuring conditions: At indoor climate. No arcing or breakdown is allowed! All connections together to ground.	500 VAC / 1 Sec.	
Isolation resistance Measuring conditions: After 48h of storage at 95% R.H. and 25°C measured with U=500 VDC for 1 min.	RI > 10 MOhm	
clearance / creepage distance	1,0 mm / 1,2 mm	
Protection class	III	

5.2 Approval Tests

CE	EC Declaration of Conformity	Yes
EAC	Eurasian Conformity	Yes
UL	Underwriters Laboratories	Yes / UL507, Electric Fans
VDE	Association for Electrical, Electronic and Information Technologies	Yes / Approval acc. to EN 60950 (VDE 0805) - Information technology equipment
CSA	Canadian Standards Association	Yes / C22.2 No. 113 Fans and Ventilators
CCC	China Compulsory Certification	No

The approval tests are observed to:

U approval max.: 24,0 V @ TU approval max.: 70 °C

6 Reliability

6.1 General

Life expectancy L10 at TU = 40 °C	60.000 h	
Life expectancy L10 at TU max.	30.000 h	
Life expectancy L10 Delta (40 °C)	120.000 h	

Copies of this document, and copies of its use or reproduction of the contents thereof, are
 prohibited without express authorization. References are made to the patent of design, and copies are retained
 in the event of the need for a patent or the registration of a utility model or design.

Nachdruck und Verbreitung ohne schriftliche Genehmigung der
 ebm-papst SE, Georgen 400 A, D-72336 Heilbronn

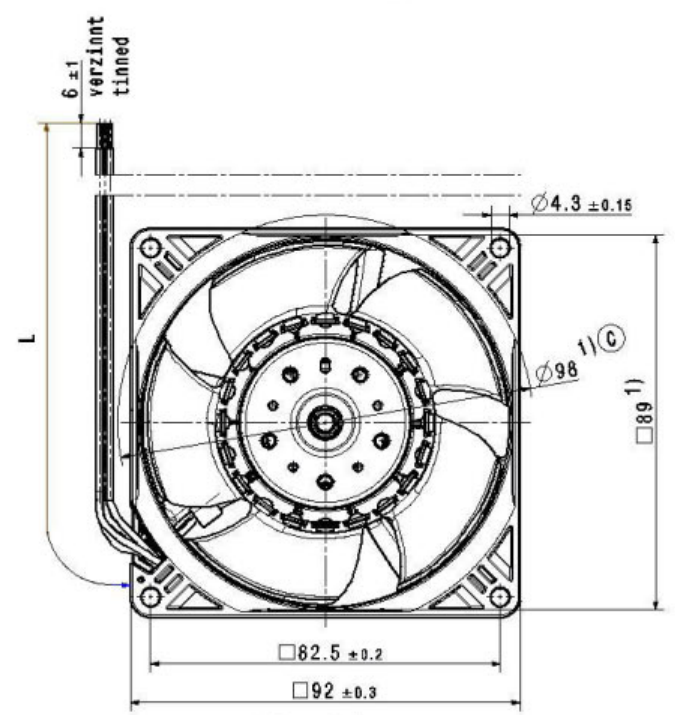

Vorderansicht
 Maßstab: 1:1
 front view
 scale: 1:1

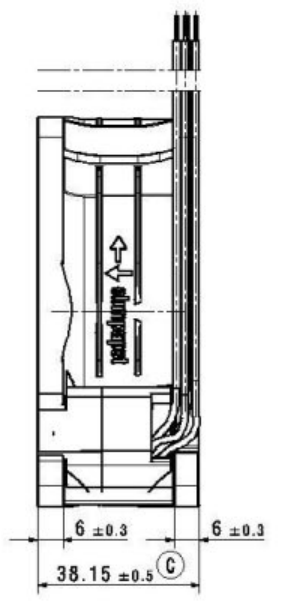

Seitenansicht links
 Maßstab: 1:1
 side view left
 scale: 1:1

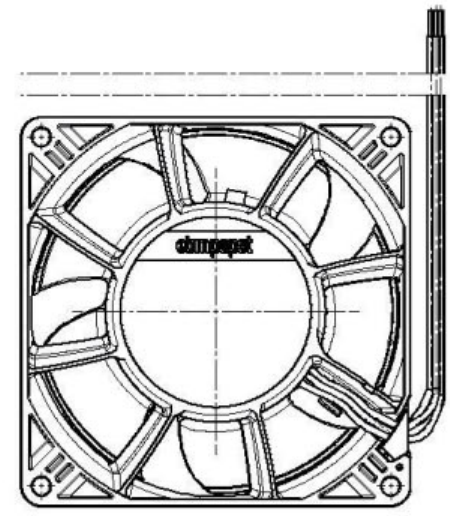

Rückansicht
 Maßstab: 1:1
 back view
 scale: 1:1

Zeichnung entspricht 3D-Modell:
 Drawing is equivalent to 3D-Model:
 9683520181_CPR_000_C
 System: CATIA V5 R 14

1) Maße für Montagewand
 1) dimension for worktop mounting

- Anzahl und Länge der Litzen siehe Produktspezifikation
number and length of the wires, look at the product specification
- Kein Axialspiel bei Kugellager durch Federausgleich
no axial clearance of ball bearings conditional on a pre-load spring

WP-Status/Type 	Prod.-Nr./ Change-No.	Q130-System-Vertrieb DTR System-Vertrieb	Q130-System-Vertrieb Q130 System-Vertrieb	Werkstoff / Material: Volumen / Volume: Gewicht / Mass (G):
		Dr: UM Name		
Toleranz / Tolerances: Kitzspezifikationen / See tolerances:	Bearb./ Exec: Fert./ Mfg.:	Art/Nr. / Type: Name	Art/Nr. / Type: Name	Zeichnung / Type of document: Teilzeichnung / (Sheet/Page):
		Zeichn.-Nr. / Drawing No.:	Fert.-T./ Prod. No.:	Fert.-T./ Prod. No.:
ebm-papst SE, Georgen 400 A D-72336		Fert.-T./ Prod. No.:	Fert.-T./ Prod. No.:	Fert.-T./ Prod. No.: