

# PolarHT™ Power MOSFET

## IXTK 120N20P IXTQ 120N20P

$$V_{DSS} = 200 \text{ V}$$

$$I_{D25} = 120 \text{ A}$$

$$R_{DS(on)} \leq 22 \text{ m}\Omega$$

N-Channel Enhancement Mode  
Avalanche Rated



TO-264 (IXTK)

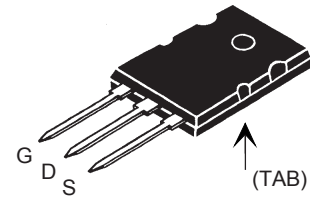

TO-3P (IXTQ)

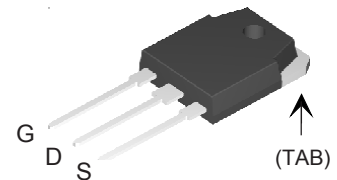

G = Gate      D = Drain  
S = Source      TAB = Drain

Symbol	Test Conditions	Maximum Ratings	
$V_{DSS}$	$T_J = 25^\circ\text{C to } 175^\circ\text{C}$	200	V
$V_{DGR}$	$T_J = 25^\circ\text{C to } 175^\circ\text{C}; R_{GS} = 1 \text{ M}\Omega$	200	V
$V_{GS}$	Continuous	$\pm 20$	V
$V_{GSM}$	Transient	$\pm 30$	V
$I_{D25}$	$T_C = 25^\circ\text{C}$	120	A
$I_{D(RMS)}$	External lead current limit	75	A
$I_{DM}$	$T_C = 25^\circ\text{C}$ , pulse width limited by $T_{JM}$	300	A
$I_{AR}$	$T_C = 25^\circ\text{C}$	60	A
$E_{AR}$	$T_C = 25^\circ\text{C}$	60	mJ
$E_{AS}$	$T_C = 25^\circ\text{C}$	2.0	J

$dv/dt$	$I_S \leq I_{DM}$ , $di/dt \leq 100 \text{ A}/\mu\text{s}$ , $V_{DD} \leq V_{DSS}$ , $T_J \leq 175^\circ\text{C}$ , $R_G = 4 \Omega$	10	V/ns
---------	---	----	------

$P_D$	$T_C = 25^\circ\text{C}$	714	W
$T_J$		-55 ... +175	$^\circ\text{C}$
$T_{JM}$		175	$^\circ\text{C}$
$T_{stg}$		-55 ... +175	$^\circ\text{C}$

$T_L$	1.6 mm (0.062 in.) from case for 10 s	300	$^\circ\text{C}$
$T_{SOLD}$	Plastic body for 10 s	260	$^\circ\text{C}$

$M_d$	Mounting torque	1.13/10	Nm/lb.in.
-------	-----------------	---------	-----------

Weight	TO-3P	5.5	g
	TO-264	10	g

Symbol	Test Conditions ( $T_J = 25^\circ\text{C}$ , unless otherwise specified)	Characteristic Values		
		Min.	Typ.	Max.
$BV_{DSS}$	$V_{GS} = 0 \text{ V}$ , $I_D = 250 \mu\text{A}$	200		V
$V_{GS(th)}$	$V_{DS} = V_{GS}$ , $I_D = 250 \mu\text{A}$	2.5		5.0 V
$I_{GSS}$	$V_{GS} = \pm 20 \text{ V}_{DC}$ , $V_{DS} = 0$			$\pm 100 \text{ nA}$
$I_{DSS}$	$V_{DS} = V_{DSS}$			25 $\mu\text{A}$
	$V_{GS} = 0 \text{ V}$			500 $\mu\text{A}$
$R_{DS(on)}$	$V_{GS} = 10 \text{ V}$ , $I_D = 0.5 I_{D25}$ Pulse test, $t \leq 300 \mu\text{s}$ , duty cycle $d \leq 2 \%$			22 $\text{m}\Omega$

### Features

- † International standard packages
- † Unclamped Inductive Switching (UIS) rated
- † Low package inductance  
- easy to drive and to protect

### Advantages

- † Easy to mount
- † Space savings
- † High power density

Symbol	Test Conditions	Characteristic Values		
		Min.	Typ.	Max.
$g_{fs}$	$V_{DS} = 10\text{ V}$ ; $I_D = 0.5 I_{D25}$ , pulse test	40	63	S
$C_{iss}$	$V_{GS} = 0\text{ V}$ , $V_{DS} = 25\text{ V}$ , $f = 1\text{ MHz}$		6000	pF
$C_{oss}$			1300	pF
$C_{rss}$			265	pF
$t_{d(on)}$	$V_{GS} = 10\text{ V}$ , $V_{DS} = 0.5 V_{DSS}$ , $I_D = I_{D25}$ $R_G = 3.3\ \Omega$ (External)		30	ns
$t_r$			35	ns
$t_{d(off)}$			100	ns
$t_f$			31	ns
$Q_{g(on)}$	$V_{GS} = 10\text{ V}$ , $V_{DS} = 0.5 V_{DSS}$ , $I_D = 0.5 I_{D25}$		152	nC
$Q_{gs}$			40	nC
$Q_{gd}$			75	nC
$R_{thJC}$				$0.21^\circ\text{C/W}$
$R_{thCS}$	TO-3P	0.21		$^\circ\text{C/W}$
$R_{thCS}$	TO-264	0.15		$^\circ\text{C/W}$

Symbol	Test Conditions	Characteristic Values		
		Min.	Typ.	Max.
$I_s$	$V_{GS} = 0\text{ V}$			120 A
$I_{SM}$	Repetitive			300 A
$V_{SD}$	$I_F = I_s$ , $V_{GS} = 0\text{ V}$ , Pulse test, $t \leq 300\ \mu\text{s}$ , duty cycle $d \leq 2\%$			1.5 V
$t_{rr}$	$I_F = 25\text{ A}$ , $-di/dt = 100\text{ A}/\mu\text{s}$ $V_R = 100\text{ V}$ , $V_{GS} = 0\text{ V}$		180	ns
$Q_{RM}$			3.0	$\mu\text{C}$

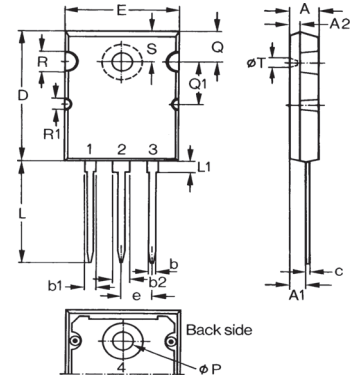
**TO-264 (IXTK) Outline**

Dim.	Millimeter		Inches	
	Min.	Max.	Min.	Max.
A	4.82	5.13	.190	.202
A1	2.54	2.89	.100	.114
A2	2.00	2.10	.079	.083
b	1.12	1.42	.044	.056
b1	2.39	2.69	.094	.106
b2	2.90	3.09	.114	.122
c	0.53	0.83	.021	.033
D	25.91	26.16	1.020	1.030
E	19.81	19.96	.780	.786
e	5.46 BSC		.215 BSC	
J	0.00	0.25	.000	.010
K	0.00	0.25	.000	.010
L	20.32	20.83	.800	.820
L1	2.29	2.59	.090	.102
P	3.17	3.66	.125	.144
Q	6.07	6.27	.239	.247
Q1	8.38	8.69	.330	.342
R	3.81	4.32	.150	.170
R1	1.78	2.29	.070	.090
S	6.04	6.30	.238	.248

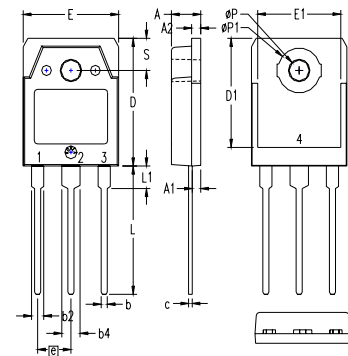
**TO-3P (IXTQ) Outline**

- 1 - GATE
- 2 - DRAIN (COLLECTOR)
- 3 - SOURCE (EMITTER)
- 4 - DRAIN (COLLECTOR)

SYM	INCHES		MILLIMETERS	
	MIN	MAX	MIN	MAX
A	.185	.193	4.70	4.90
A1	.051	.059	1.30	1.50
A2	.057	.065	1.45	1.65
b	.035	.045	0.90	1.15
b2	.075	.087	1.90	2.20
b4	.114	.126	2.90	3.20
c	.022	.031	0.55	0.80
D	.780	.799	19.80	20.30
D1	.665	.677	16.90	17.20
E	.610	.622	15.50	15.80
E1	.531	.539	13.50	13.70
e	.215 BSC		5.45 BSC	
L	.779	.795	19.80	20.20
L1	.134	.142	3.40	3.60
phi P	.126	.134	3.20	3.40
phi P1	.272	.280	6.90	7.10
S	.193	.201	4.90	5.10

IXYS reserves the right to change limits, test conditions, and dimensions.

IXYS MOSFETs and IGBTs are covered by	4,835,592	4,931,844	5,049,961	5,237,481	6,162,665	6,404,065 B1	6,683,344	6,727,585
one or more of the following U.S. patents:	4,850,072	5,017,508	5,063,307	5,381,025	6,259,123 B1	6,534,343	6,710,405B2	6,759,692
	4,881,106	5,034,796	5,187,117	5,486,715	6,306,728 B1	6,583,505	6,710,463	6,771,478 B2

**Fig. 1. Output Characteristics**  
**@ 25°C**

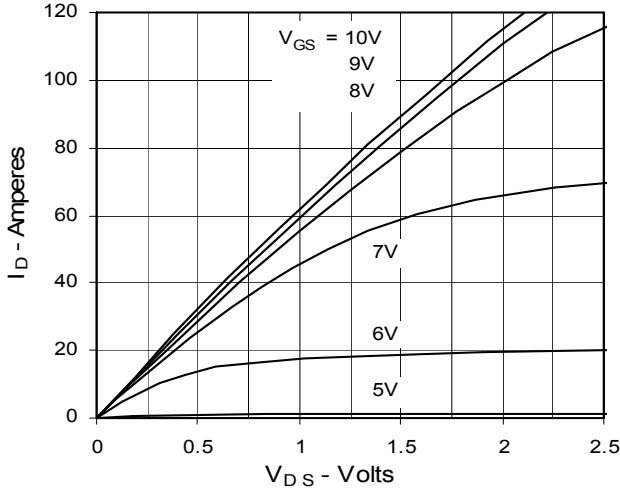

**Fig. 2. Extended Output Characteristics**  
**@ 25°C**

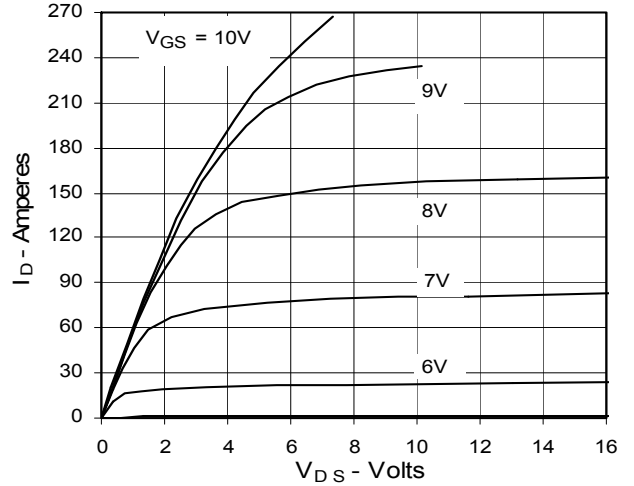

**Fig. 3. Output Characteristics**  
**@ 150°C**

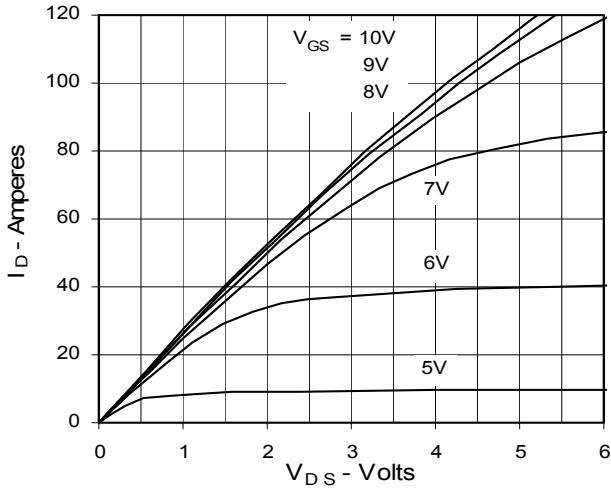

**Fig. 4.  $R_{DS(on)}$  Normalized to 0.5  $I_{D25}$  Value vs. Junction Temperature**

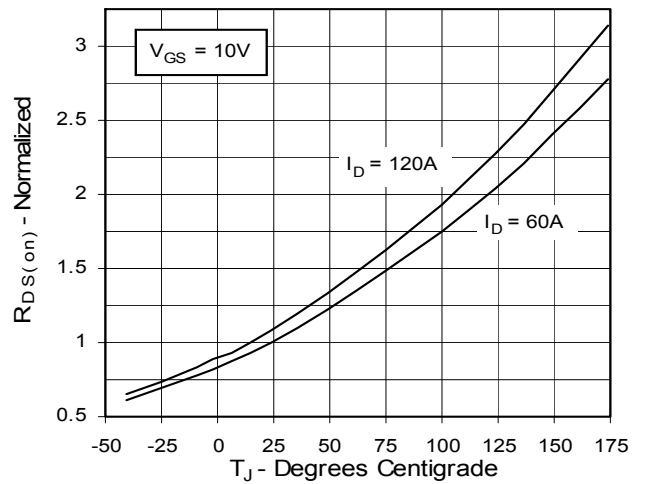

**Fig. 5.  $R_{DS(on)}$  Normalized to 0.5  $I_{D25}$  Value vs. Drain Current**

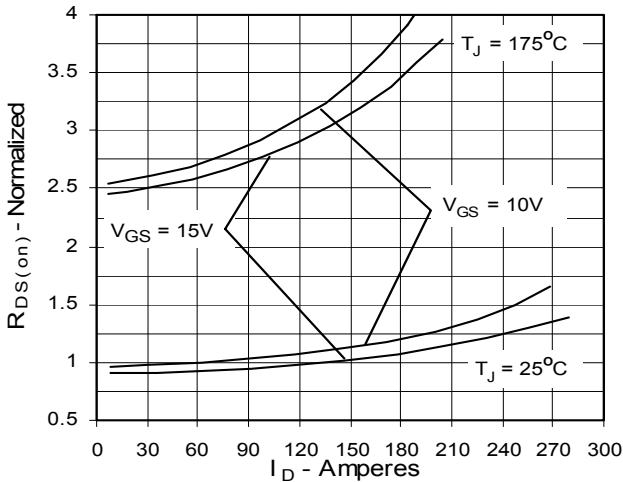

**Fig. 6. Drain Current vs. Case Temperature**

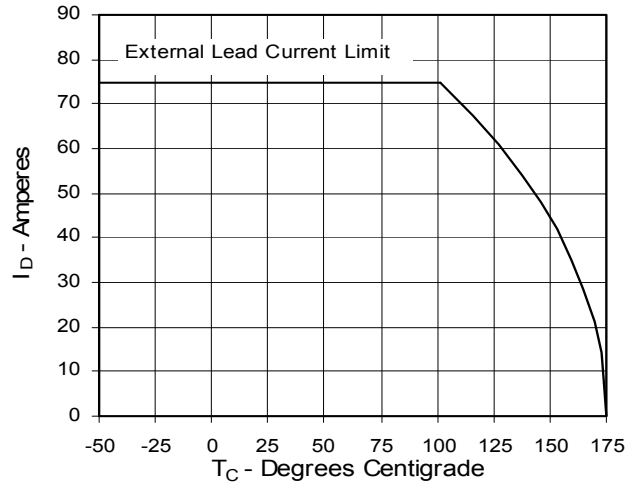

**Fig. 7. Input Admittance**

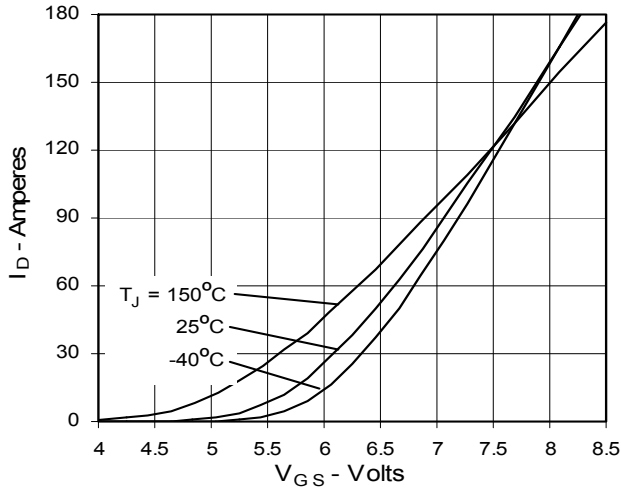

**Fig. 8. Transconductance**

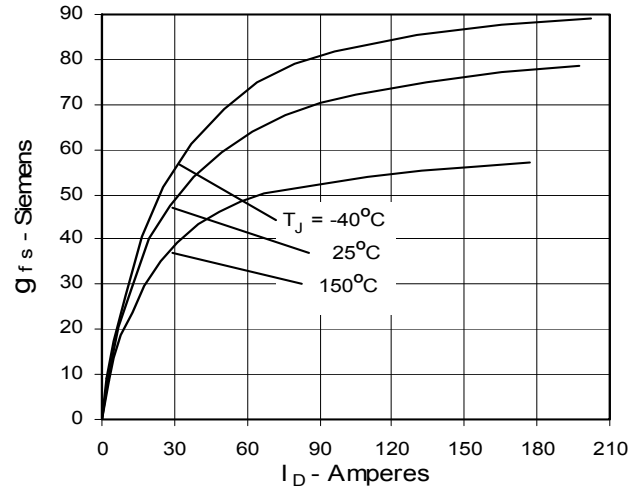

**Fig. 9. Source Current vs. Source-To-Drain Voltage**

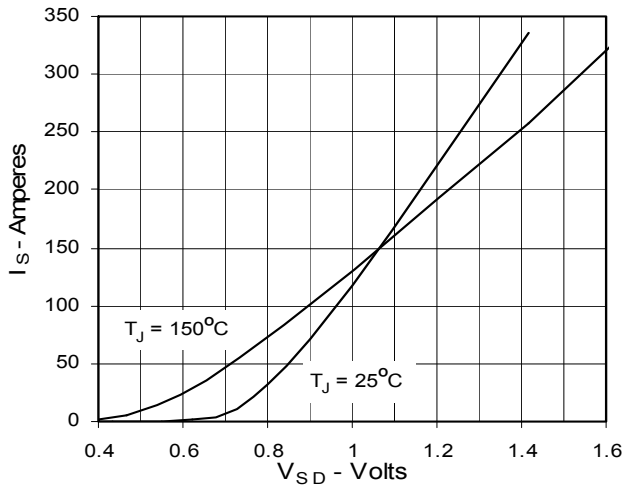

**Fig. 10. Gate Charge**

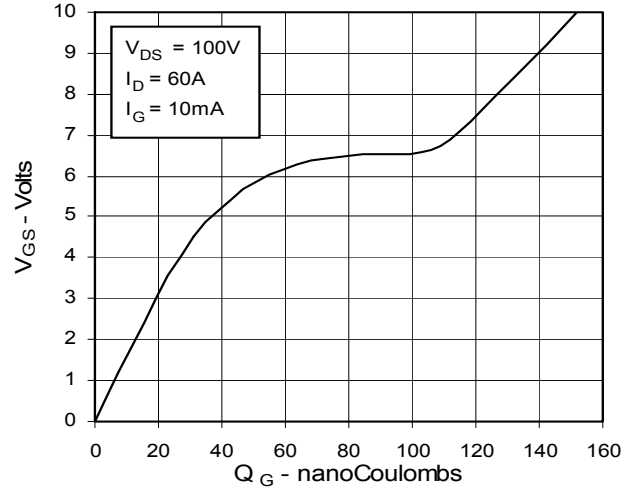

**Fig. 11. Capacitance**

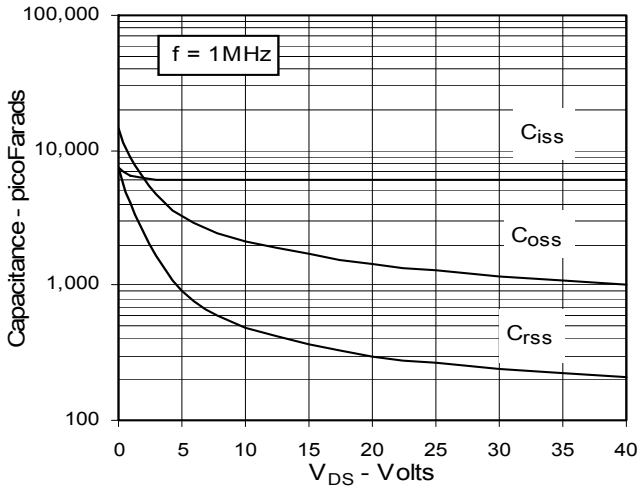

**Fig. 12. Forward-Bias Safe Operating Area**

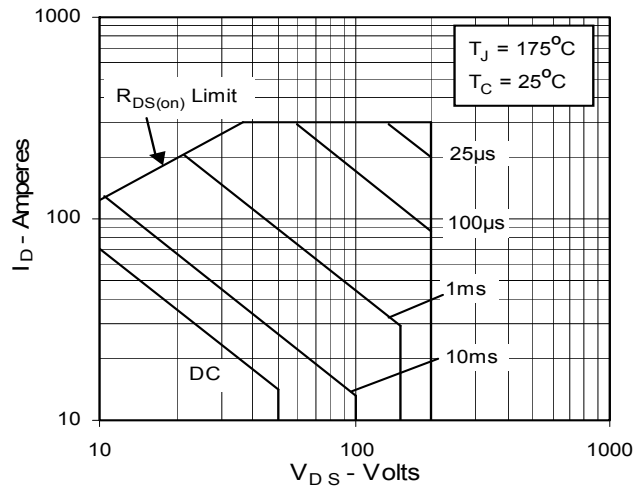

Fig. 13. Maximum Transient Thermal Resistance

