CP2130 EVALUATION KIT USER'S GUIDE

1. Introduction

The CP2130 Evaluation Kit consists of a CP2130 Evaluation Board and software package to demonstrate the use of the CP2130 USB-to-SPI bridge to communicate with several SPI slave devices, including an on-board SPI ADC and SPI EEPROM. Several PC applications are included to demonstrate the CP2130 features and evaluate SPI performance.

2. Kit Contents

The CP2130 Evaluation Kit contains the following items:

- CP2130 Evaluation Board
- Mini-USB Cable
- CP21xx Installation DVD
- Quick Start Guide

3. Relevant Documentation

Application notes can be found on the Interface Application Notes page for all fixed-function devices: www.silabs.com/interface-appnotes.

- **AN721: CP21xx Device Customization Guide**—Customize the VID, PID, serial number, and other parameters stored in the CP2130 one-time programmable ROM.
- **AN792: CP2130 Interface Specification**—Describes the USB control and bulk transfers for CP2130 devices as well as GPIO configuration.

4. Software Setup

The Software Development Kit (SDK) for the CP2130 Evaluation Kit is included on the kit DVD. The latest version of this installer can also be downloaded from the www.silabs.com/cp2130ek web site. This package includes:

- **Documentation**—data sheet, application notes, user's guide, quick start guide, and SLAB_USB_SPI interface library API documentation.
- **CP2130 Demo**—Example software utilizing the SLAB_USB_SPI interface library API to demonstrate the CP2130 Evaluation Board features.
- **CP2130 Evaluation Tool**—Advanced evaluation software used to execute low-level SPI transfers, control GPIO outputs, and retrieve device information.
- **AN721 Device Customization Utility**—Customization software used to program the one-time programmable ROM.
- **Library**—SLAB_USB_SPI interface library and header files used to interface between a user application and USB driver such as Microsoft's WinUSB driver.

The Windows installer should launch automatically after inserting the DVD. Follow the instructions to install the SDK to the system.

CP2130-EK

5. CP2130 Hardware Interface

1. Connect the CP2130 Evaluation Board to a PC as shown in Figure 1.
2. Connect one end of the mini-USB cable to a USB Port on the PC.
3. Connect the other end of the mini-USB cable to the mini-USB connector on the CP2130 Evaluation Board.

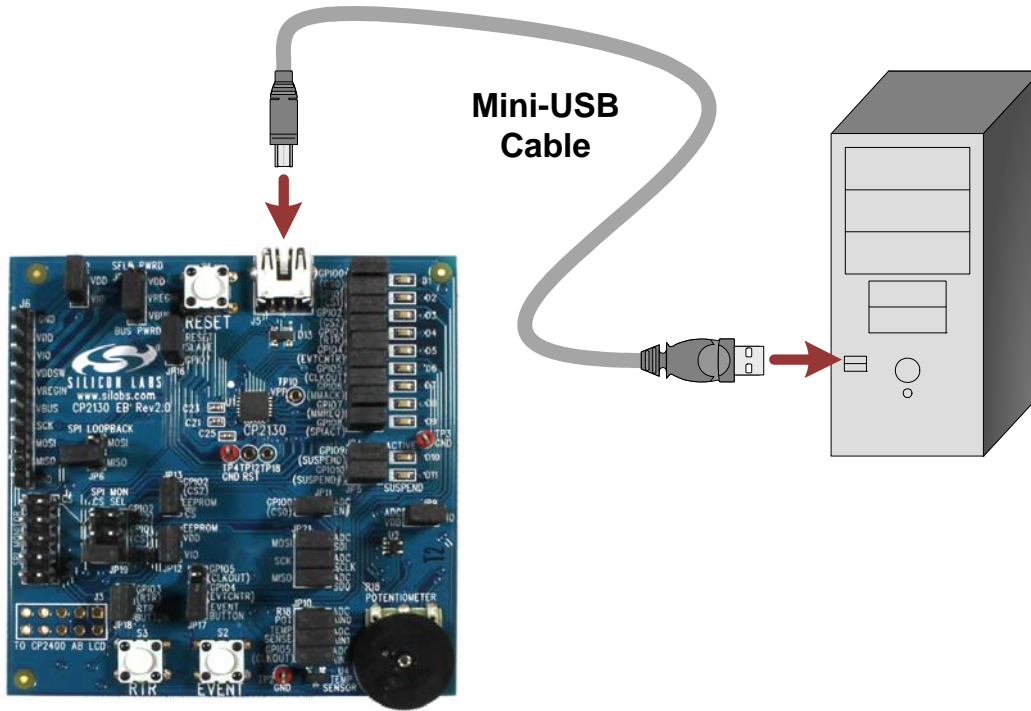

Figure 1. Hardware Setup

6. CP2130 WinUSB Driver Installation

The CP2130 is a vendor-specific USB device with control and bulk endpoints and typically requires the installation of a generic USB driver. To facilitate this process in Windows, Silicon Labs provides a custom driver INF file and Microsoft Driver Package Installer (DPInst) to install the Microsoft WinUSB driver. The SDK installer will automatically install the driver on Windows machines.

The CP2130 appears as a “Silicon Labs CP2130 USB to SPI Bridge” in Device Manager as shown in Figure 2.

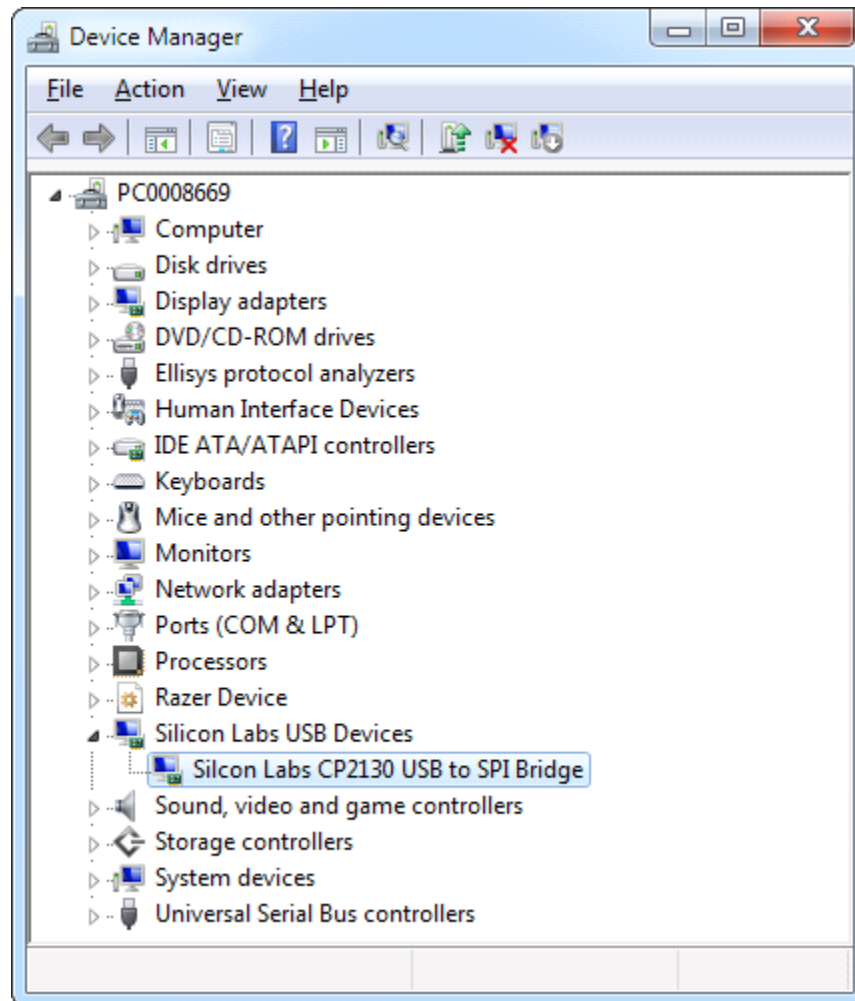

Figure 2. CP2130 in Device Manager

7. CP2130 Software Interface

The SLAB_USB_SPI interface library is provided to interface between the user application and USB to control the CP2130. The SLAB_USB_SPI interface library documentation describes the API software functions that can be used to read or write SPI data and control the CP2130 from the PC. The **CP2130 Demo** software application uses the SLAB_USB_SPI interface library to demonstrate the CP2130 Evaluation Board capabilities. The **CP2130 Evaluation Tool** is an advanced tool used to execute low-level SPI transfers.

8. CP2130 Demo Windows Application

The **CP2130 Demo** uses the Windows SLAB_USB_SPI interface DLL to communicate with the on-board SPI slave devices via the CP2130 USB-to-SPI bridge. The application controls the CP2130, which communicates with an external 3-channel ADC and SPI EEPROM. Using the default jumper configuration, the 3-channel ADC is connected to a potentiometer, external temperature sensor, and GPIO.5, the CP2130 CLKOUT signal. The following steps describe how to start the application and demonstrate some of its features.

1. Make sure that the hardware is connected to a Windows PC as shown in Figure 1. If the device is properly connected, the green Active LED on the CP2130 Evaluation Board will turn on. After a few seconds of inactivity, the green Active LED may turn off, and the red Suspend LED will then turn on to indicate that the device has entered USB suspend mode. This is part of a power-saving feature called USB selective suspend.
2. Launch the **CP2130 Demo** application, which is found by clicking **Start→All Programs→Silicon Laboratories→CP2130 Evaluation Kit→CP2130 Demo**.
3. This application demonstrates the features of the CP2130 Evaluation Board and requires the default Jumper configuration and default one-time programmable ROM configuration. Click on the **Jumper Config** button to launch the help window.
4. The **Jumper Config** window display the factory default jumper configuration. Install shorting blocks to match the jumper locations outlined in red.

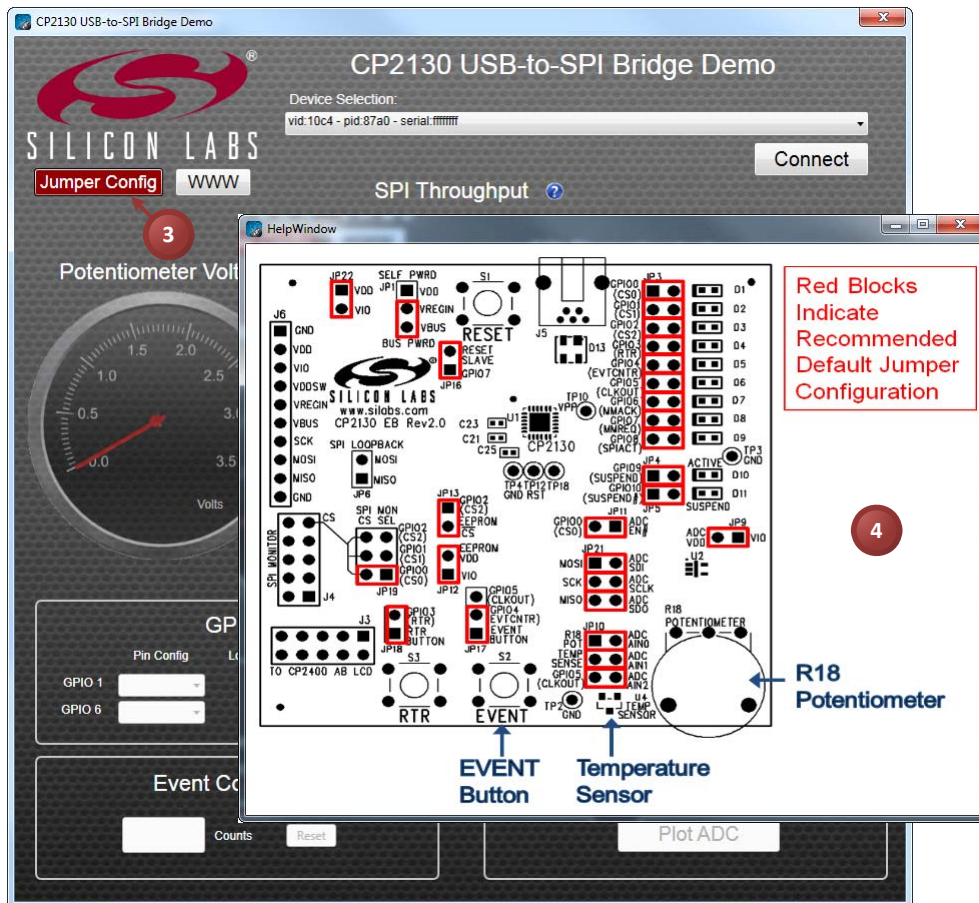

Figure 3. Configuring the CP2130 Evaluation Board Shorting Blocks

5. Connect to the CP2130 USB-to-SPI bridge by selecting the device in the **Device Selection** combo box and clicking the **Connect** button.

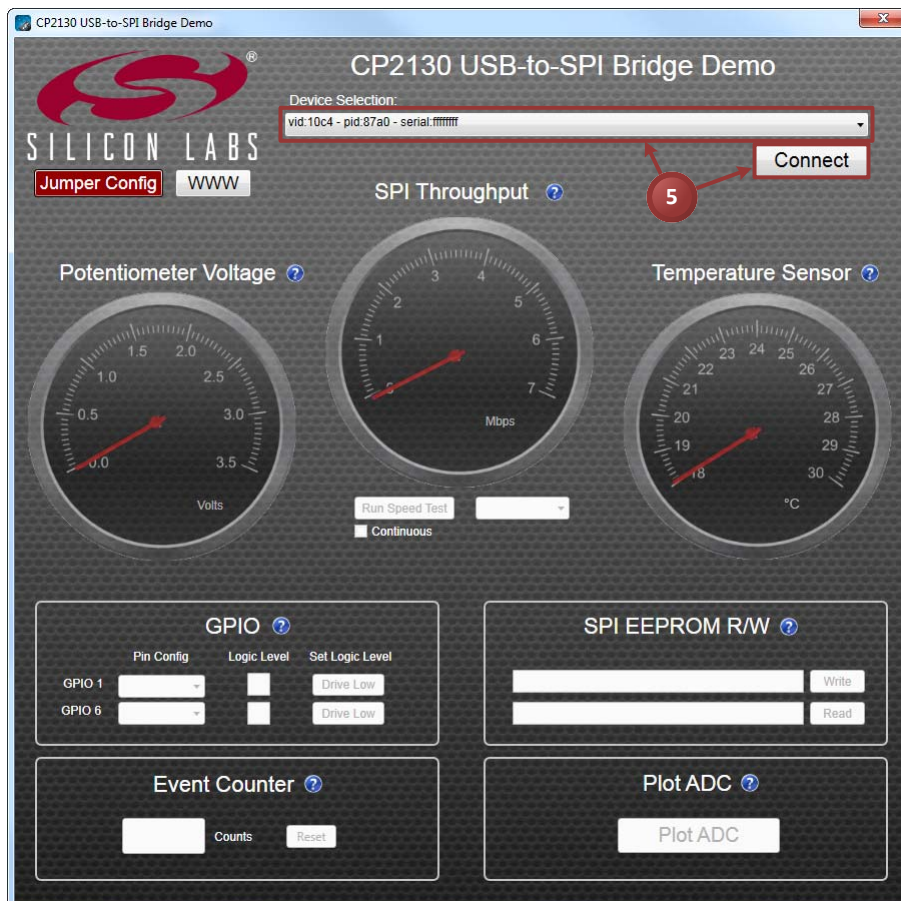

Figure 4. Connecting to a CP2130 Evaluation Board

CP2130-EK

6. Observe the potentiometer voltage displayed in the **Potentiometer Voltage** gauge. Rotate the potentiometer and watch the voltage change.
7. Observe the temperature sensor value displayed in the **Temperature Sensor** gauge.

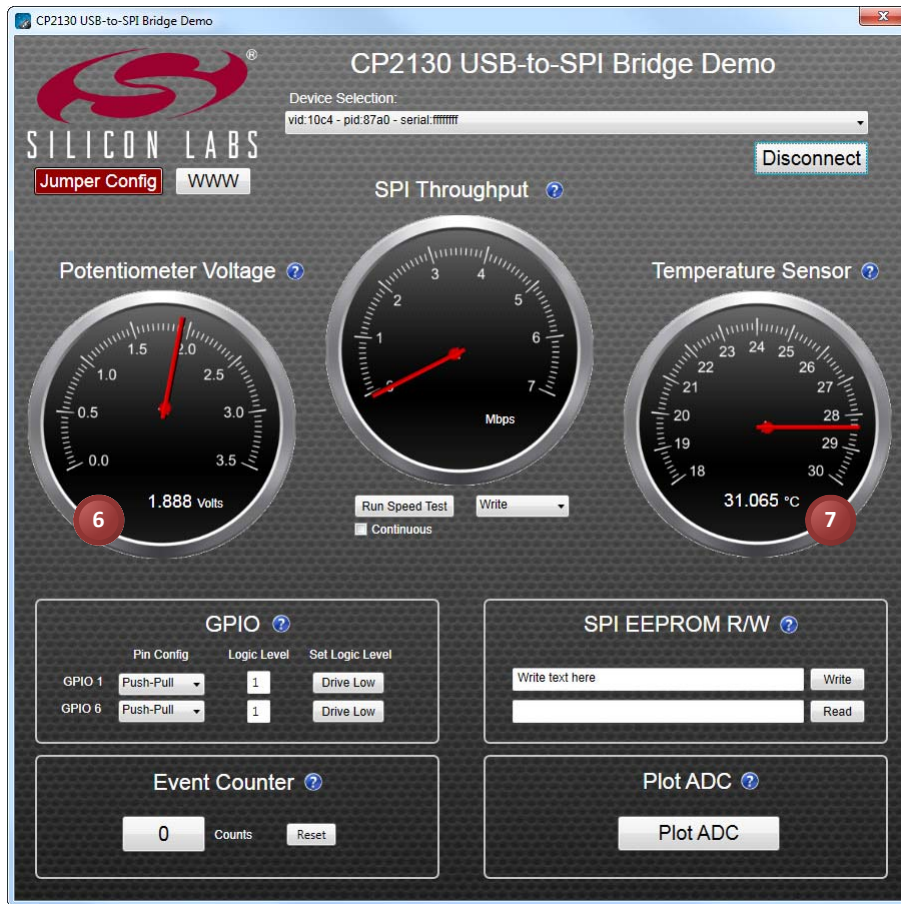

Figure 5. Reading the Potentiometer and Temperature Sensor ADC Channel Inputs

8. Run SPI throughput tests using $\overline{CS1}$:
 - a. Select the transfer mode from the combo box. The following SPI transfer modes are available: **Write**, **Read**, **Write/Read** (simultaneous write and read).
 - b. Click the **Run Speed Test** button to run a short throughput test using the selected transfer mode or click the **Continuous** checkbox and then click **Run Speed Test** to run a continuous throughput test. Click **Stop Speed Test** to cancel a continuous throughput test.
 - c. Observe the throughput measurement in the **SPI Throughput** gauge.

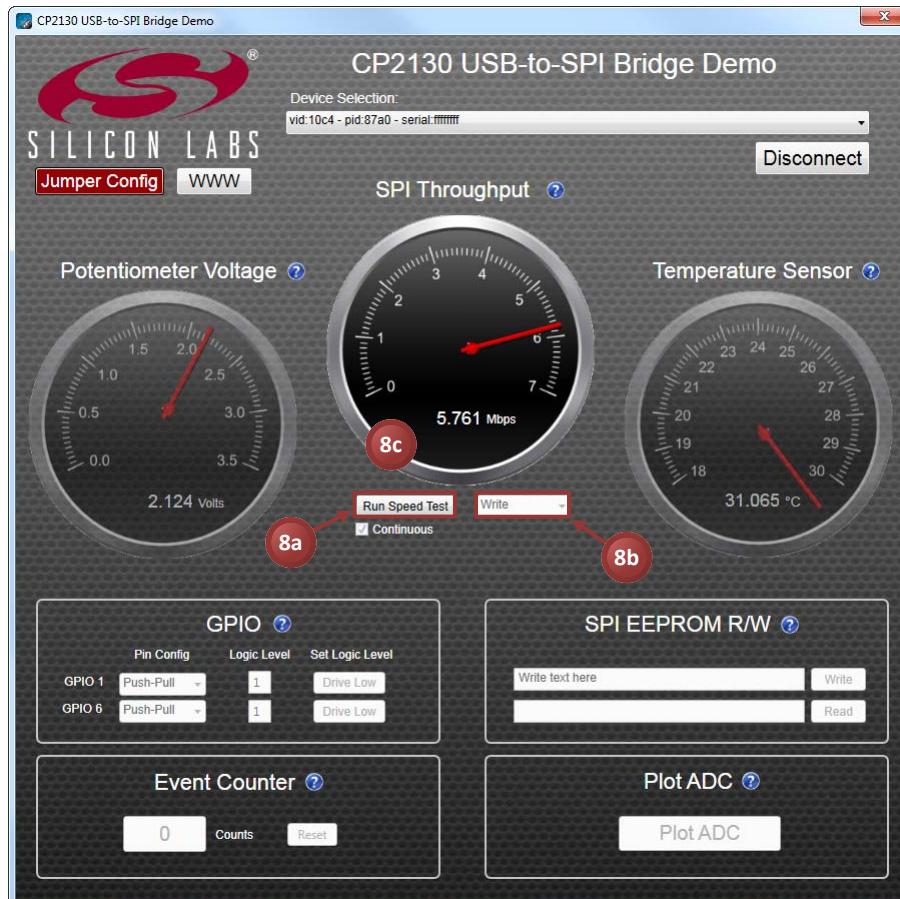

Figure 6. Running SPI Throughput Tests

CP2130-EK

9. Configure the general purpose input/output (GPIO) pins and read and write the pin latch values:
 - a. Select the GPIO pin mode from the **Pin Config** combo box. The following pin modes are available: **Input**, **Open Drain**, or **Push-Pull**. When a GPIO pin is configured in **Input** mode, the latch value can only be read and not written. When the GPIO pin is configured for **Open Drain** mode, the pin is either weakly pulled up to VIO or driven low. When the GPIO pin is configured for **Push-Pull** mode, the pin is driven either high or low.
 - b. Read the current state of the GPIO pin latch from the **Logic Level** text field.
 - c. Toggle the GPIO pin latch value by clicking the **Drive High/Drive Low** button. Clicking **Drive High** will set the latch value to '1'. Clicking **Drive Low** will set the latch value to '0'. Observe the new latch value by reading the **Logic Level** text field. By default, each GPIO pin is connected to an LED. Driving a latch value of '0' will turn the LED on. Driving a latch value of '1' will turn the LED off.

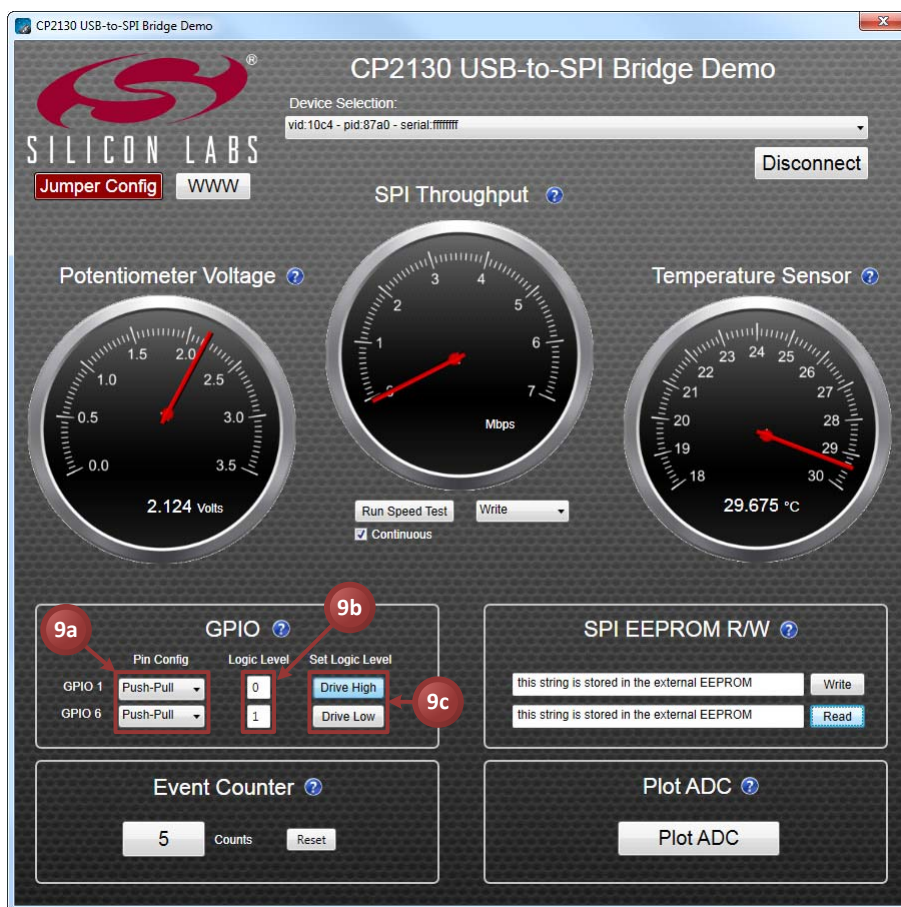

Figure 7. Controlling GPIO Pins

10. Write and read back a string to the external SPI EEPROM:
 - a. Enter a string into the Write text box. Click the **Write** button to write the string to the external EEPROM.
 - b. Click the **Read** button to read the string from the external EEPROM and display the string in the Read text box.

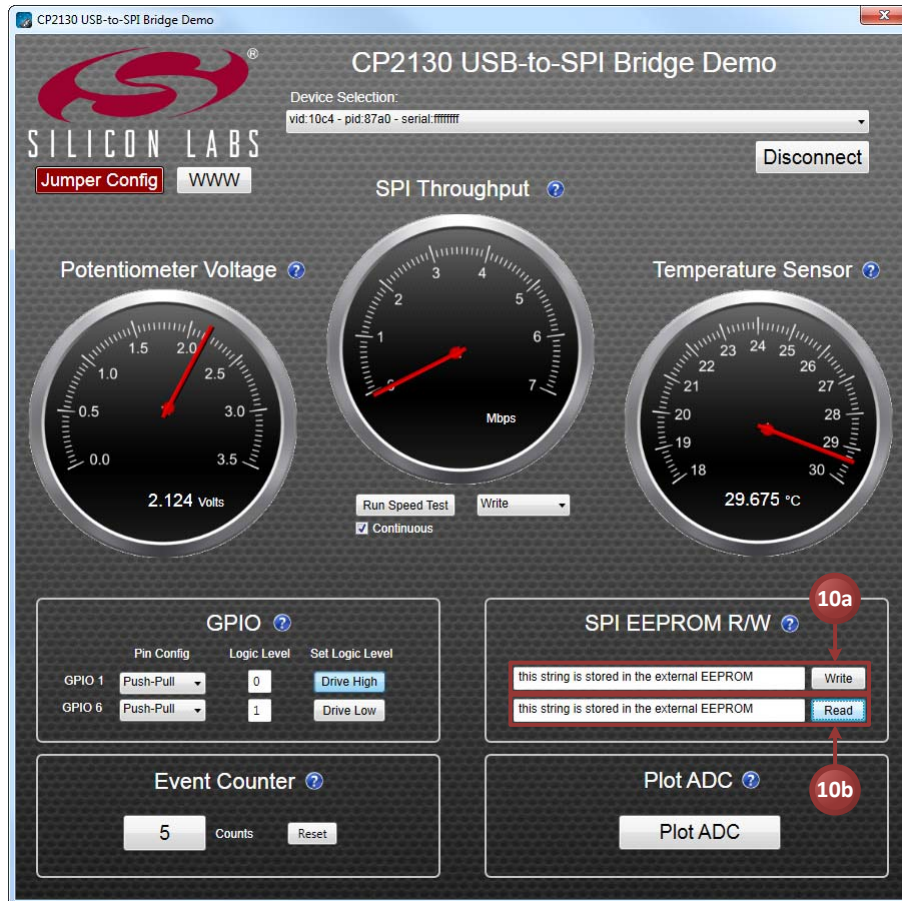

Figure 8. Reading and Writing the SPI EEPROM

CP2130-EK

11. Use the CP2130 event counter feature to monitor push-button presses on the **EVENT** button which is connected to GPIO.4 / CS4 / EVTCNTR:
 - a. Press the **EVENT** button on the CP2130 Evaluation Board. Notice that the **Event Counter Counts** field updates to reflect the total number of button presses.
 - b. Click the **Reset** button in the application to clear the event count back to zero.

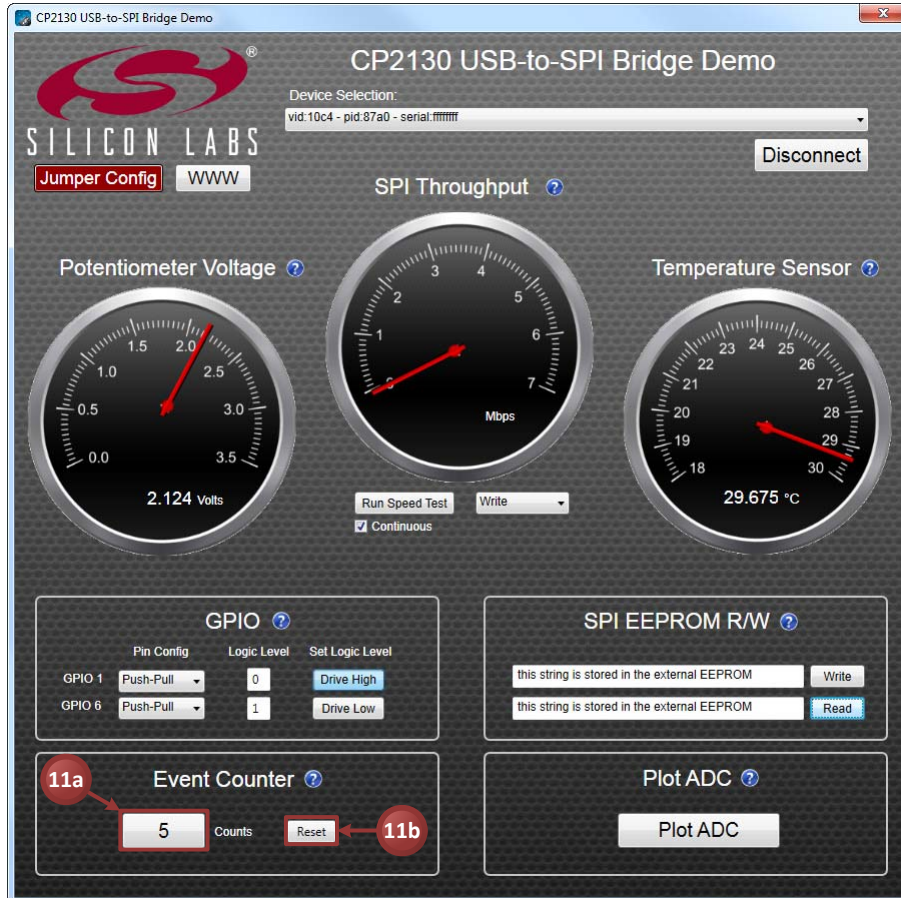

Figure 9. Monitoring Push-Button Presses Using the Event Counter

12. Plot the ADC analog input sample values:
 - a. Click the **Plot ADC** button to open the plot window.
 - b. Select one of the three ADC channels to plot. The following ADC channels are available: **Potentiometer (CH.0)**, **Temp Sensor (CH.1)**, or **(CH.2)**. By default, Channel 2 is connected to GPIO.5 / CS5 / CLKOUT. Other analog signals may be connected to any of the ADC analog inputs and plotted using the plot window.
 - c. View the graph of the selected ADC input channel.

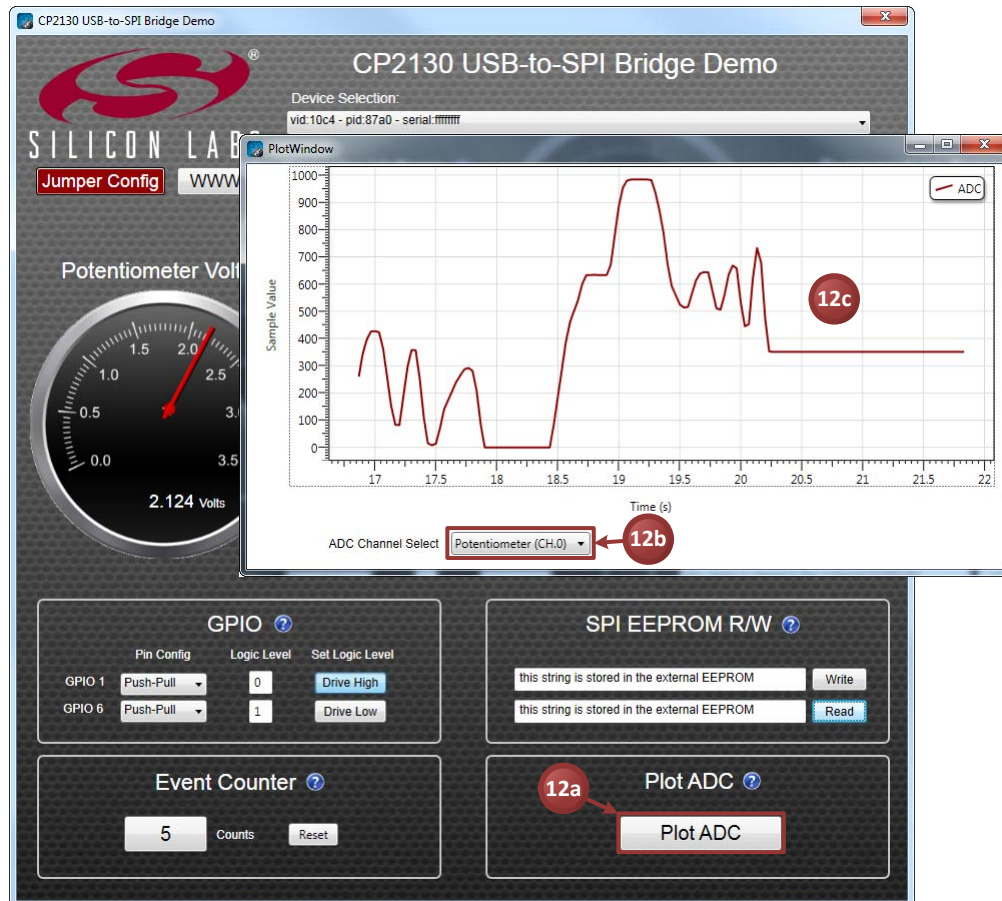

Figure 10. Plotting ADC Sample Values

9. CP2130 Evaluation Tool Windows Application

The **CP2130 Evaluation Tool** uses the Windows SLAB_USB_SPI interface DLL to retrieve CP2130 device information and execute SPI read and/or write transfers. The following steps describe how to start the application and demonstrate some of its features.

1. Make sure that the hardware is connected to a Windows PC as shown in Figure 1. If the device is properly connected, the green Active LED on the CP2130 Evaluation Board will turn on. After a few seconds of inactivity, the green Active LED may turn off, and the red Suspend LED will then turn on to indicate that the device has entered USB suspend mode. This is part of a power-saving feature called USB selective suspend.
2. Launch the **CP2130 Evaluation Tool** application, which is found by clicking **Start→All Programs→Silicon Laboratories→CP2130 Evaluation Kit→CP2130 Evaluation Tool**.
3. Select the CP2130 device path in the **Choose device** combo box.
4. Click the **Connect** button to connect to the device.

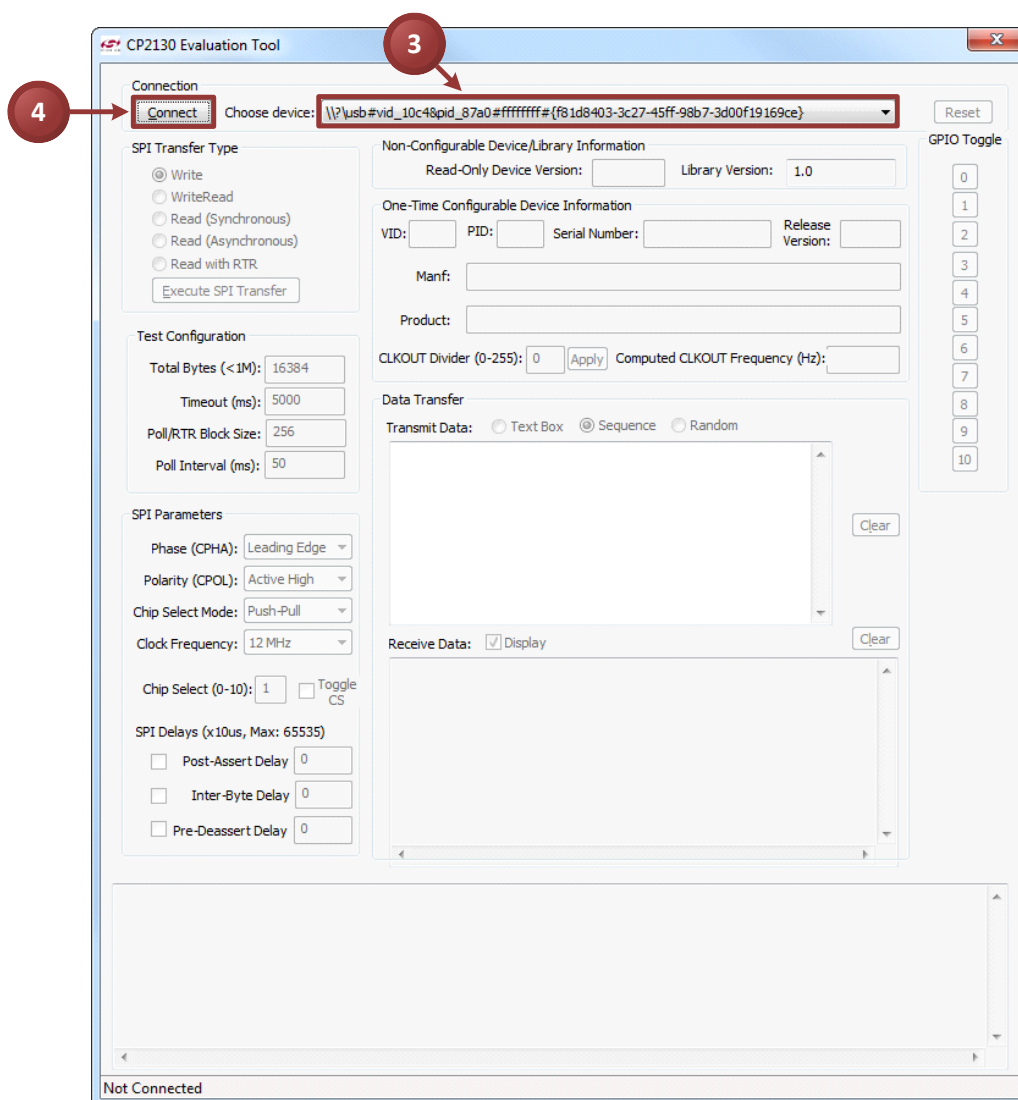

Figure 11. Connecting to a CP2130 Device Using the Evaluation Tool

5. Once connected to a device, the application displays non-configurable and one-time configurable device information. The following text fields are updated:
 - a. **Read-Only Device Version**—The CP2130 read-only device version
 - b. **Library Version**—The SLAB_USB_SPI.dll version
 - c. **VID**—The CP2130 USB vendor ID
 - d. **PID**—The CP2130 USB product ID
 - e. **Serial Number**—The CP2130 USB serial string
 - f. **Release Version**—The CP2130 USB BCD device release number
 - g. **Manf**—The CP2130 USB manufacturer string
 - h. **Product**—The CP2130 USB product string
 - i. **CLKOUT Divider**—The GPIO.5 / $\overline{CS5}$ / CLKOUT clock output frequency divider value. When GPIO.5 is configured for CLKOUT mode, this divider is used to control the output frequency. The CLKOUT divider reset value is stored in the one-time programmable ROM but may be changed at runtime.
 - j. **Computed CLKOUT Frequency**—The CLKOUT frequency calculated from the CP2130 system clock divided by the CLKOUT divider.

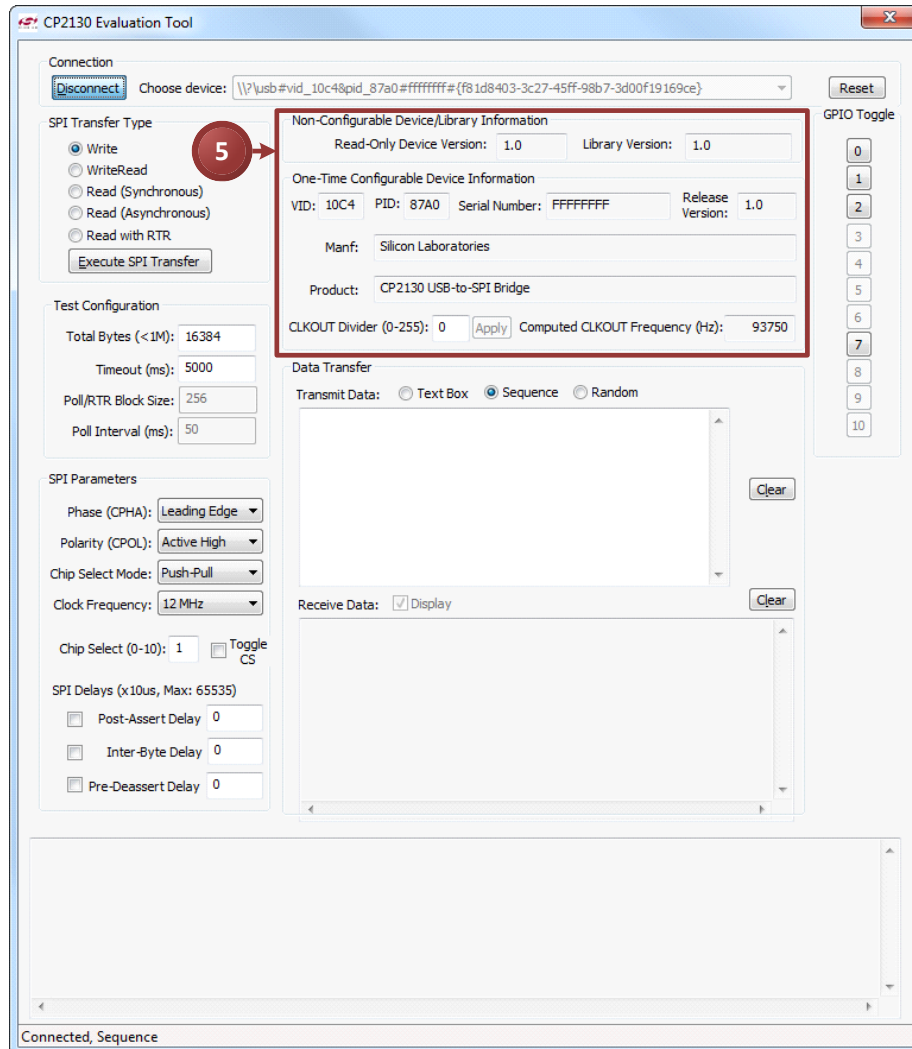

Figure 12. Connected Device Information

6. To configure an SPI data transfer:
 - a. Select one of the following transfer types from the **SPI Transfer Type** radio buttons:
 - i. **Write**—Execute a synchronous SPI write. Write the data as specified in the **Transmit Data** section.
 - ii. **WriteRead**—Execute a synchronous, simultaneous SPI write and read. Write the data as specified in the **Transmit Data** section and return the read data in the **Receive Data** section.
 - iii. **Read (Synchronous)**—Execute a synchronous SPI read. The read data is returned in the **Receive Data** section.
 - iv. **Read (Asynchronous)**—Execute an asynchronous SPI read. The read data is returned in the **Receive Data** section. An asynchronous read can be aborted before the specified timeout has elapsed and before the specified number of bytes are read by clicking on the **Abort Read Operation** button.
 - v. **Read with RTR**—Execute an asynchronous SPI read with RTR. The CP2130 will read bytes only when the GPIO.3 / $\overline{\text{CS3}}$ / RTR signal is asserted. The read data is returned in the **Receive Data** section. An asynchronous read with RTR can be aborted before the specified number of bytes are read by clicking on the **Abort Read Operation** button.
 - b. Enter values in the **Test Configuration** text fields:
 - i. **Total Bytes (<1M)**—Specifies the total number of bytes to read or write. For a WriteRead operation, this field specifies the number of bytes that will be read and the number of bytes that will be written.
 - ii. **Timeout (ms)**—Specifies the timeout for SPI transfer operations in milliseconds. If the specified total number of bytes isn't read or written in the time specified, the operation will timeout and abort.
 - iii. **Poll/RTR Block Size**—For an asynchronous read and a read with RTR, the poll/RTR block size specifies the number of bytes to read from the library buffer during each poll interval period.
 - iv. **Poll Interval (ms)**—For asynchronous read and read with RTR, the poll interval specifies how frequently to check for SPI read data in milliseconds.
 - c. Configure the SPI parameters:
 - i. **Phase (CPHA)**—Specifies the SPI clock phase: **Leading Edge, Trailing Edge**
 - ii. **Polarity (CPOL)**—Specifies the SPI clock polarity: **Active High, Active Low**
 - iii. **Chip Select Mode**—Specifies the output mode for the specified chip select pin: **Open Drain, Push-Pull**
 - iv. **Clock Frequency**—Specifies the SPI clock frequency: **12 MHz, 6 MHz, 3 MHz, 1.5 MHz, 750 kHz, 375 kHz, 187.5 kHz, 93.75 kHz**
 - v. **Chip Select (0–10)**—Specifies which chip-select pin is asserted during SPI transfers: $\overline{\text{CS0}}$ – $\overline{\text{CS10}}$
 - vi. **Toggle CS**—Specifies that the chip-select pin will be toggled after each SPI byte transferred.
 - vii. **Post-Assert Delay**—Specifies the amount of time that the CP2130 will delay after the last SPI byte has been transferred before deasserting the chip-select pin. The delay is in units of 10 μs .
 - viii. **Inter-Byte Delay**—Specifies the amount of time that the CP2130 will delay between SPI byte transfers. The delay is in units of 10 μs .
 - ix. **Pre-Deassert Delay**—Specifies the amount of time that the CP2130 will delay after asserting the chip-select pin before the first SPI byte is transferred. The delay is in units of 10 μs .

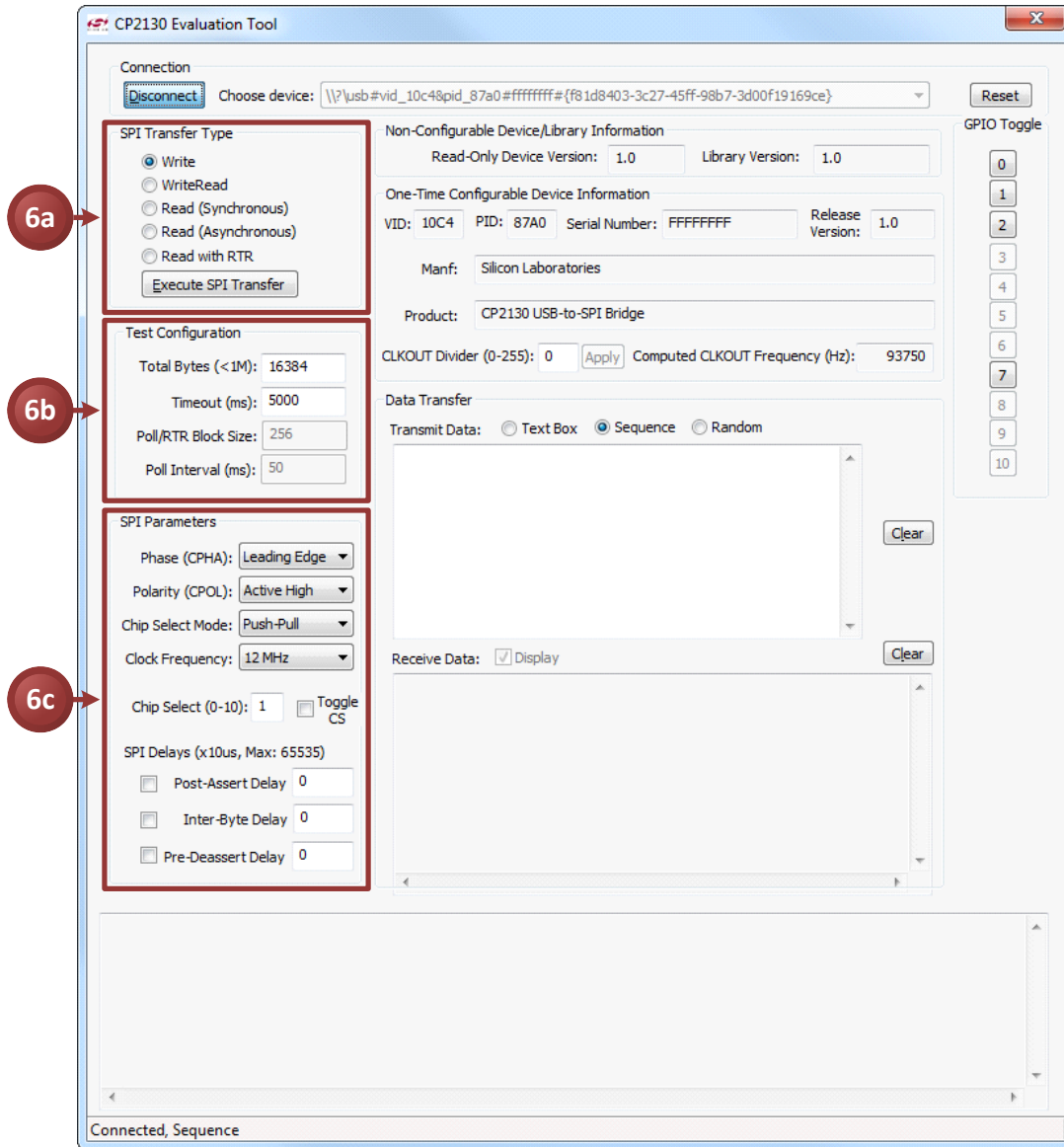

Figure 13. Configuring an SPI Transfer

7. To execute a WriteRead SPI transfer:
 - a. Select the **WriteRead** radio button from the **SPI Transfer Type** group box.
 - b. Configure the **Test Configuration** and **SPI Parameters**, making sure to enter the number of bytes to read/write in the **Total Bytes (<1M)** text field.
 - c. Specify the data to write in the SPI transfer by selecting one of the following **Transmit Data** radio buttons:
 - i. Text Box—Enter comma-separated, hexadecimal byte values into the **Transmit Data** text box and send the data in the write transfer.
 - ii. Sequence—Write sequential data starting from 0x00 to 0xFF and repeat until the specified number of bytes are written.
 - iii. Random—Write random data until the specified number of bytes are written.
 - d. Click the **Execute SPI Transfer** button to start the WriteRead SPI transfer.
 - e. The data being read will be displayed in the **Receive Data** text box if the **Display** check box is checked.
 - f. The SPI transfer status and statistics will be displayed in the output text box at the bottom of the dialog.

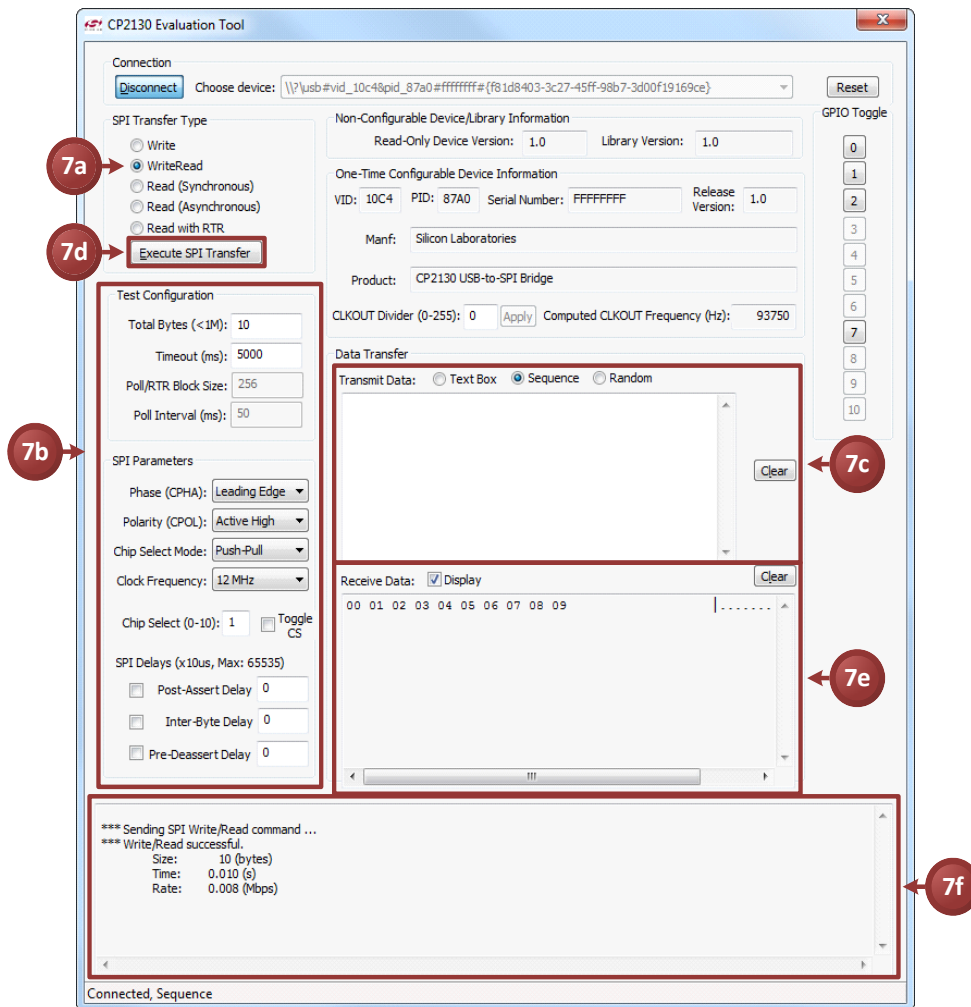

Figure 14. Executing a WriteRead SPI Transfer

8. To execute an asynchronous Read SPI transfer:
 - a. Select the **Read (Asynchronous)** radio button from the **SPI Transfer Type** group box.
 - b. Enter the maximum number of bytes to read in the **Total Bytes (<1M)** text field. Enter a maximum timeout, which specifies the maximum amount of time the read transfer can take in milliseconds. Enter the poll block size in bytes and poll interval in milliseconds.
 - c. Click the **Execute SPI Transfer** button to start the asynchronous read transfer. The button will change to **Abort Read Operation** while the transfer is in progress. This button can be clicked to abort the current read before the timeout elapses or the total number of bytes is read.
 - d. The received data will be displayed in the **Receive Data** text box when the application reads the poll block size every poll interval.
 - e. The asynchronous read transfer status will be displayed in the output text box and the status of each poll interval will be logged.

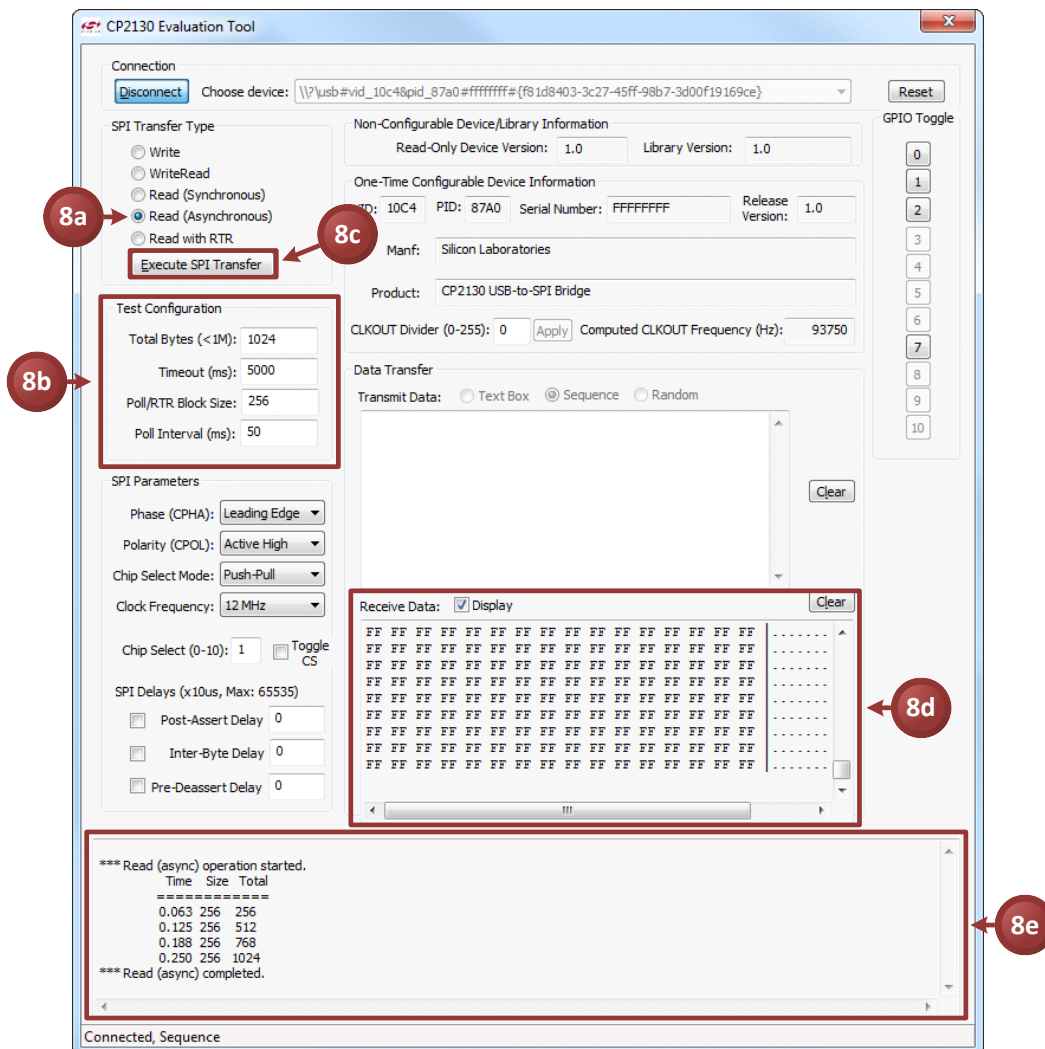

Figure 15. Executing an Asynchronous Read SPI Transfer

CP2130-EK

9. Click the **Reset** button to send the Reset command to the CP2130. After the device receives this command, it will perform a reset and re-enumerate on the bus.
10. GPIO pins configured as GPIO outputs can be controlled using the **GPIO Toggle** buttons. Click the GPIO pin **0–10** button to toggle the output latch value. GPIO pins not configured as GPIO outputs are grayed out.

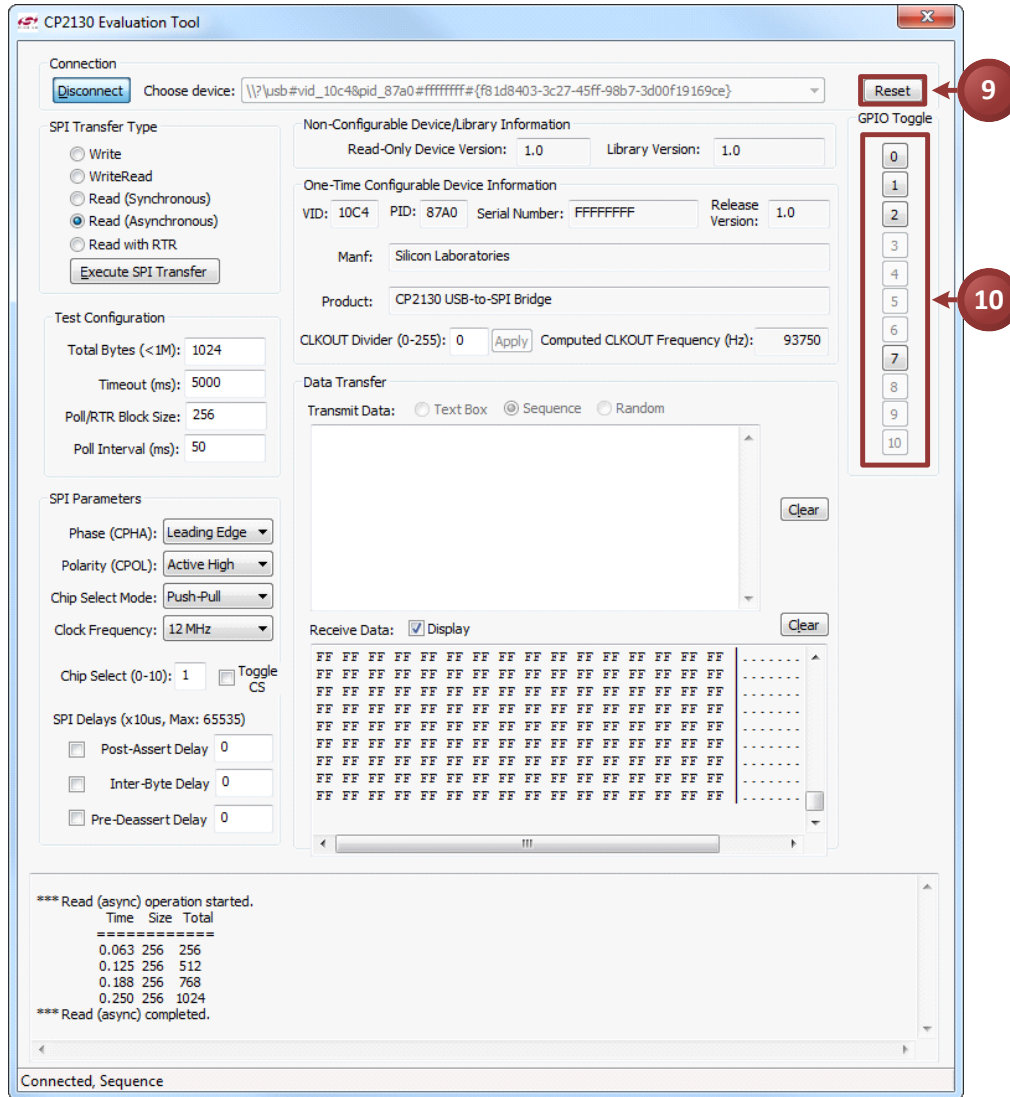

Figure 16. Resetting the Device and Toggling GPIO Pins

10. CP2130 Evaluation Board Overview

The CP2130 Evaluation Kit includes an evaluation board with a CP2130 pre-installed for evaluation and preliminary software development. The evaluation board also contains two SPI slave devices: an Si8902 Isolated Monitoring ADC and a 256 x 8 SPI EEPROM. Figure 17 and Figure 18 highlight the CP2130 Evaluation Board features.

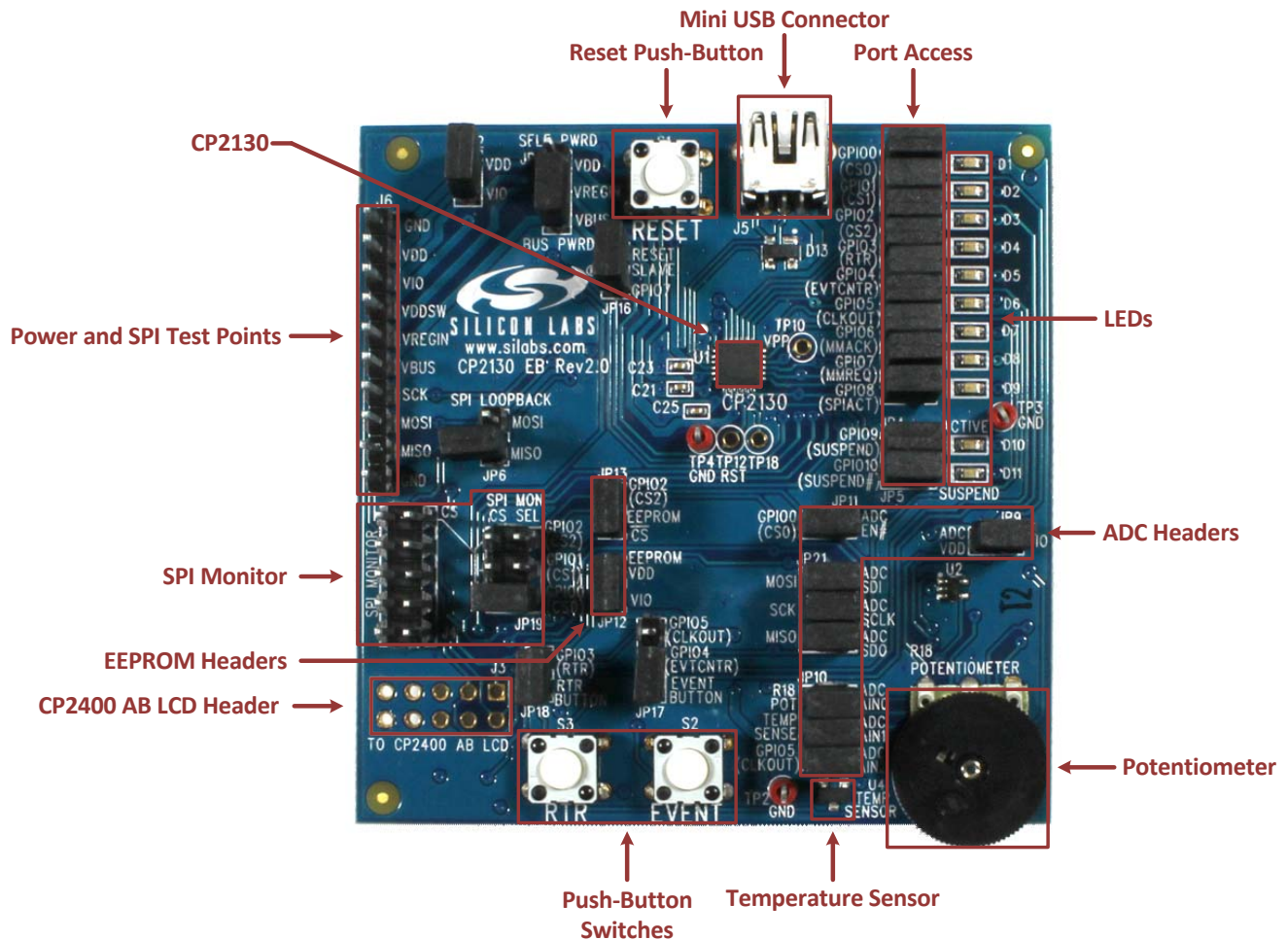

Figure 17. CP2130 Evaluation Board Features (Front)

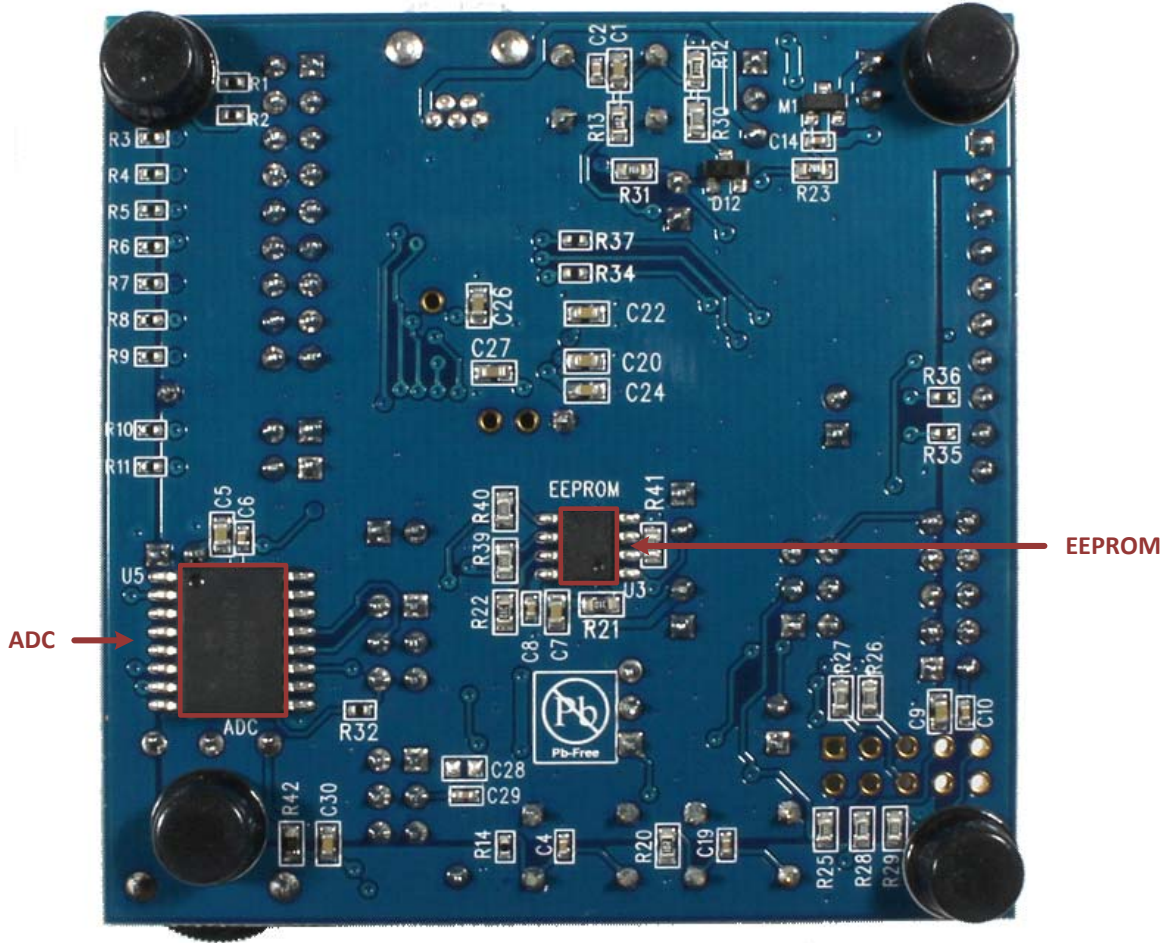

Figure 18. CP2130 Evaluation Board Features (Back)

10.1. CP2130 Evaluation Board Components

Numerous input/output (I/O) connections are provided to facilitate prototyping using the evaluation board. Refer to Figure 19 for the locations of the various I/O connectors. For each header in Figure 19, Pin 1 is indicated with a square pin. Refer to Figure 20 for a complete schematic.

D1–D9	Green GPIO.0–GPIO.8 LEDs
D10	Green GPIO.9 (SUSPEND) LED
D11	Red GPIO.10 (SUSPEND) LED
J3	CP2400 AB LCD header
J4	SPI monitor header
J5	Mini-USB connector
J6	Power and SPI test points
JP1	VREGIN input header
JP3–JP5	LED headers
JP6	SPI loopback header
JP9	ADC VDD header
JP10	ADC channel input header
JP11	ADC chip-select header
JP12	EEPROM VDD header
JP13	EEPROM chip-select header
JP16	ADC RST header
JP17	Event counter input header
JP18	RTR button header
JP19	SPI monitor chip-select input header
JP21	ADC SPI header
JP22	VIO header
R18	Potentiometer
S1	RESET button
S2	RTR button
S3	EVENT button

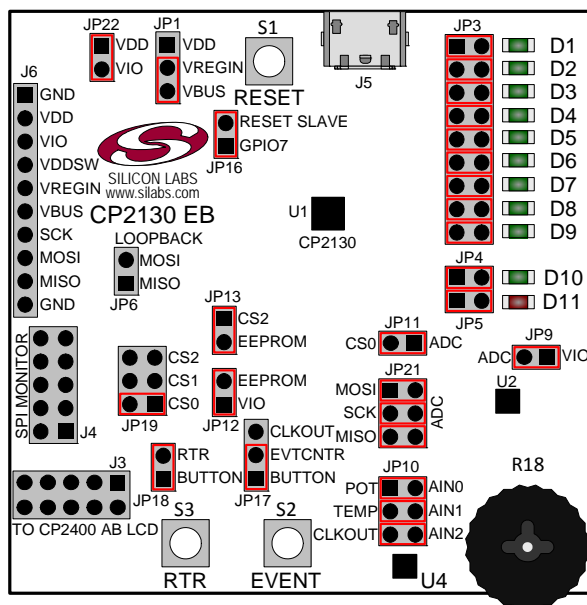

Figure 19. CP2130 Evaluation Board with Default Shorting Blocks Installed

CP2130-EK

10.2. CP2400 AB LCD Header (J3)

This header can be used to connect the CP2130 to a CP2400 AB LCD expansion board.

10.3. SPI Monitor Header (J4)

The SPI monitor terminal block is included to easily interface with a SPI monitoring device with a common 10-pin ribbon cable interface. See Table 1 for the SPI monitor pin definitions.

Table 1. SPI Monitor Pin Definitions

Pin #	Definition
1	No Connect
2	GND
3	No Connect
4	No Connect
5	MISO
6	No Connect
7	SCK
8	MOSI
9	SPI_MON_CS (See Section 10.17)
10	GND

10.4. Mini-Universal Serial Bus (USB) Connector (J5)

A Mini-Universal Serial Bus (USB) connector (J5) is provided to facilitate connections to the USB interface on the CP2130. See Table 2 for the USB pin definitions.

Table 2. Mini-USB Connector Pin Definitions

Pin #	Definitions
1	VBUS
2	D-
3	D+
4	ID (No Connect)
5	GND (Ground)

10.5. Power and SPI Test Points (J6)

Pins 1–6 of the test point header (J6) provide easy access to the GND, VDD, VIO, VDDSW, VREGIN, and VBUS power signals. Pins 7–10 provide easy access to the SCK, MOSI, MISO, and GND SPI signals. See Table 3 for the test point pin definitions.

Table 3. Power and SPI Pin Definitions

Type	Pin #	Definition
Power	1	GND
	2	VDD
	3	VIO
	4	VDDSW (Switched Supply)
	5	VREGIN
	6	VBUS
SPI	7	SCK
	8	MOSI
	9	MISO
	10	GND

10.6. VREGIN Input Header (JP1)

The CP2130 can be configured to operate in one of two power modes:

- USB self-powered mode (Short Pins 1–2 on JP1)—VREGIN is shorted to VDD, the CP2130 internal voltage regulator is disabled, and an external supply voltage must be connected to the VDD test point. Do not exceed the maximum VDD voltage specification!
- USB bus-powered mode (Short Pins 2–3 on JP1)—VREGIN is shorted to VBUS and the CP2130 internal voltage regulator is enabled. The board VDD is powered by the CP2130 internal voltage regulator output.

See Table 4 for the VREGIN input header pin definitions.

Table 4. VREGIN Input Header Pin Definitions

Pin #	Definitions
1	VDD (Self-Powered)
2	VREGIN
3	VBUS (Bus-Powered)

10.7. LED Headers (JP3, JP4, and JP5)

Headers JP3, JP4, and JP5 are provided to allow access to the GPIO pins on the CP2130. Place shorting blocks on JP3, JP4, and JP5 to connect the GPIO pins to the ten green LEDs, D1–D10, and the one red LED, D11. These LEDs can be used to indicate active communications through the CP2130. Table 5 lists the LED corresponding to each header position.

Table 5. JP3, JP4, and JP5 LED Header Locations

GPIO Pin	LED	Pins
GPIO.0 / $\overline{\text{CS0}}$	D1	JP3[1:2]
GPIO.1 / $\overline{\text{CS1}}$	D2	JP3[3:4]
GPIO.2 / $\overline{\text{CS2}}$	D3	JP3[5:6]
GPIO.3 / $\overline{\text{CS3}}$ / RTR	D4	JP3[7:8]
GPIO.4 / $\overline{\text{CS4}}$ / EVTCNTR	D5	JP3[9:10]
GPIO.5 / $\overline{\text{CS5}}$ / CLKOUT	D6	JP3[11:12]
GPIO.6 / $\overline{\text{CS6}}$	D7	JP3[13:14]
GPIO.7 / $\overline{\text{CS7}}$	D8	JP3[15:16]
GPIO.8 / $\overline{\text{CS8}}$ / SPIACT	D9	JP3[17:18]
GPIO.9 / $\overline{\text{CS9}}$ / SUSPEND	D10	JP4[1:2]
GPIO.10 / $\overline{\text{CS10}}$ / $\overline{\text{SUSPEND}}$	D11	JP5[1:2]

10.8. SPI Loopback Header (JP6)

To short the SPI MOSI and MISO signals, install a shorting block on JP6. This shorting block should be removed during normal SPI operation. See Table 6 for the SPI loopback header pin definitions.

Table 6. SPI Loopback Header Pin Definitions

Pin #	Definitions
1	MISO
2	MOSI

10.9. ADC VDD Header (JP9)

This header provides access to the ADC VDD pin. Install a shorting block on JP9 to provide power to the ADC from VIO. See Table 7 for the ADC VDD header pin definitions.

Table 7. ADC VDD Header Pin Definitions

Pin #	Definitions
1	VIO
2	ADC VDD

10.10. ADC Channel Input Header (JP10)

This header provides access to the ADC channel inputs (AIN0, AIN1, AIN2). Table 8 lists the ADC analog inputs corresponding to each header position.

Table 8. ADC Channel Input Header Locations

Analog Source	Analog Input	Pins
Potentiometer	AIN0	JP10[1:2]
Temperature Sensor	AIN1	JP10[3:4]
GPIO.5 / $\overline{\text{CS5}}$ / CLKOUT	AIN2	JP10[5:6]

10.11. ADC Chip-Select Header (JP11)

This header provides access to the ADC enable pin. Install a shorting block on JP11 to enable the ADC using the CP2130 CS0 pin. See Table 9 for the ADC chip-select header pin definitions.

Table 9. ADC Chip-Select Header Pin Definitions

Pin #	Definitions
1	ADC Enable
2	GPIO.0 / $\overline{\text{CS0}}$

10.12. EEPROM VDD Header (JP12)

This header provides access to the EEPROM VDD pin. Install a shorting block on JP12 to provide power to the EEPROM from VIO. See Table 10 for the EEPROM VDD header pin definitions.

Table 10. EEPROM VDD Header Pin Definitions

Pin #	Definitions
1	VIO
2	EEPROM VDD

10.13. EEPROM Chip-Select Header (JP13)

This header provides access to the EEPROM chip-select pin. Install a shorting block on JP13 to connect the CP2130 CS2 pin to the EEPROM chip-select pin. See Table 11 for the EEPROM chip select header pin definitions.

Table 11. EEPROM Chip-Select Header Pin Definitions

Pin #	Definitions
1	ADC Enable
2	GPIO.2 / $\overline{\text{CS2}}$

10.14. ADC RST Header (JP16)

This header provides access to the ADC reset pin. Install a shorting block on JP16 to allow the CP2130 to control the ADC reset pin via GPIO.7. See Table 12 for the ADC reset header pin definitions.

Table 12. ADC Reset Header Pin Definitions

Pin #	Definitions
1	GPIO.7 / $\overline{\text{CS7}}$
2	ADC RST

10.15. Event Counter Input Header (JP17)

The CP2130 GPIO.4 / $\overline{\text{CS4}}$ / EVTCNTR pin can be configured to count edges/pulses on one of two signals:

- Event Button (Short Pins 1–2 on JP17)—Count events from the event button.
- GPIO.5 / $\overline{\text{CS5}}$ / CLKOUT (Short Pins 2–3 on JP17)—Count events from the GPIO.5 / $\overline{\text{CS5}}$ / CLKOUT signal.

See Table 13 for the event counter input header pin definitions.

Table 13. Event Counter Input Header Pin Definitions

Pin #	Definitions
1	EVENT Button
2	GPIO.4 / $\overline{\text{CS4}}$ / EVTCNTR
3	GPIO.5 / $\overline{\text{CS5}}$ / CLKOUT

10.16. RTR Button Header (JP18)

This header provides access to the RTR button signal. Install a shorting block on JP18 to connect the RTR button to the CP2130 GPIO.3 / $\overline{\text{CS3}}$ / RTR pin. See Table 14 for the RTR button header pin definitions.

Table 14. RTR Header Pin Definitions

Pin #	Definitions
1	RTR Button
2	GPIO.3 / $\overline{\text{CS3}}$ / RTR

10.17. SPI Monitor Chip-Select Input Header (JP19)

The SPI_MON_CS signal can be configured to use one of the following three chip-select signals:

- $\overline{\text{CS0}}$ (Short Pins 1–2 on JP19)
- $\overline{\text{CS1}}$ (Short Pins 3–4 on JP19)
- $\overline{\text{CS2}}$ (Short Pins 5–6 on JP19)

See Table 15 for the SPI monitor chip-select input header pin definitions.

Table 15. SPI Monitor Chip-Select Input Header Pin Definitions

SPI_MON_CS	Pins
$\overline{\text{CS0}}$	JP19[1:2]
$\overline{\text{CS1}}$	JP19[3:4]
$\overline{\text{CS2}}$	JP19[5:6]

10.18. ADC SPI Header (JP21)

This header provides access to the ADC SPI signals (SDI, SCLK, SDO). Install shorting blocks to connect each SPI signal to the appropriate CP2130 SPI pin. Table 16 lists the ADC SPI signals corresponding to each header position.

Table 16. ADC SPI Header Locations

ADC SPI Signal	CP2130 SPI Signal	Pins
SDI	MOSI	JP21[1:2]
SCLK	SCK	JP21[3:4]
SDO (Buffered)	MISO	JP21[5:6]

10.19. VIO Header (JP22)

This header provides access to the CP2130 VIO pin. Install a shorting block on JP22 short VIO to VDD. See Table 17 for the VIO header pin definitions.

Table 17. VIO Header Pin Definitions

Pin #	Definitions
1	VDD
2	VIO

11. Schematics

Board Power Options

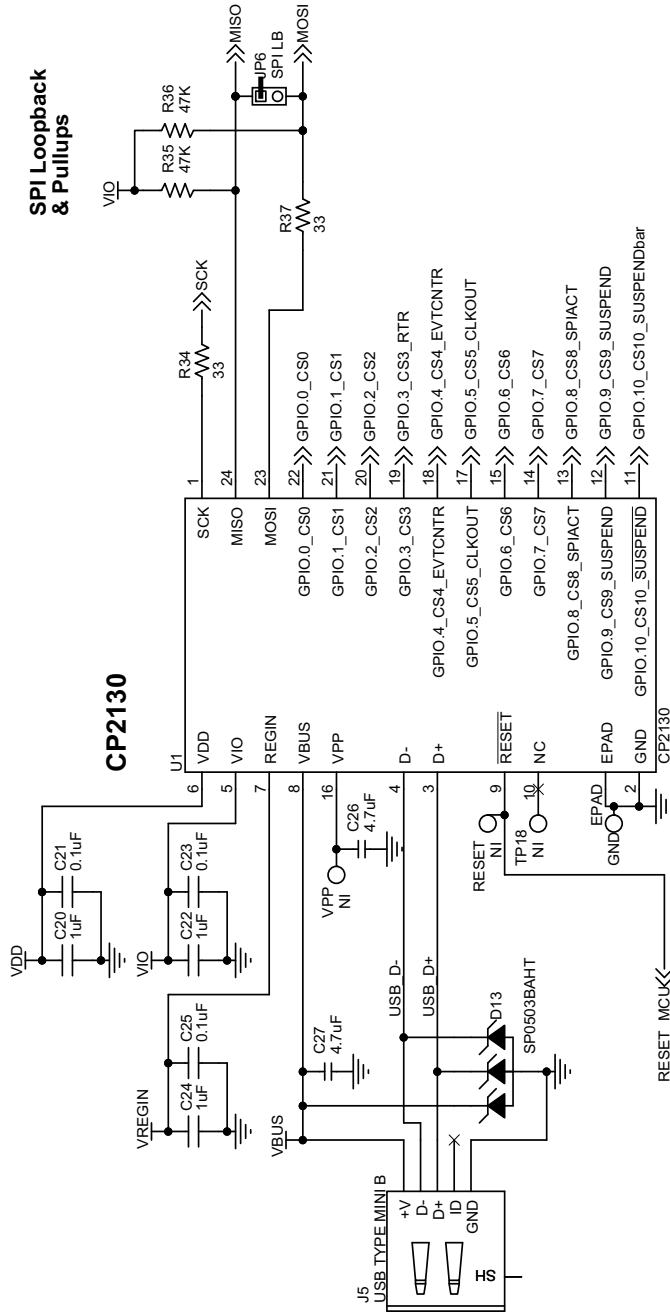
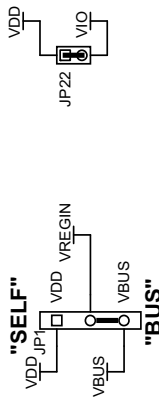

Figure 20. CP2130 Evaluation Board Schematic (1 of 2)

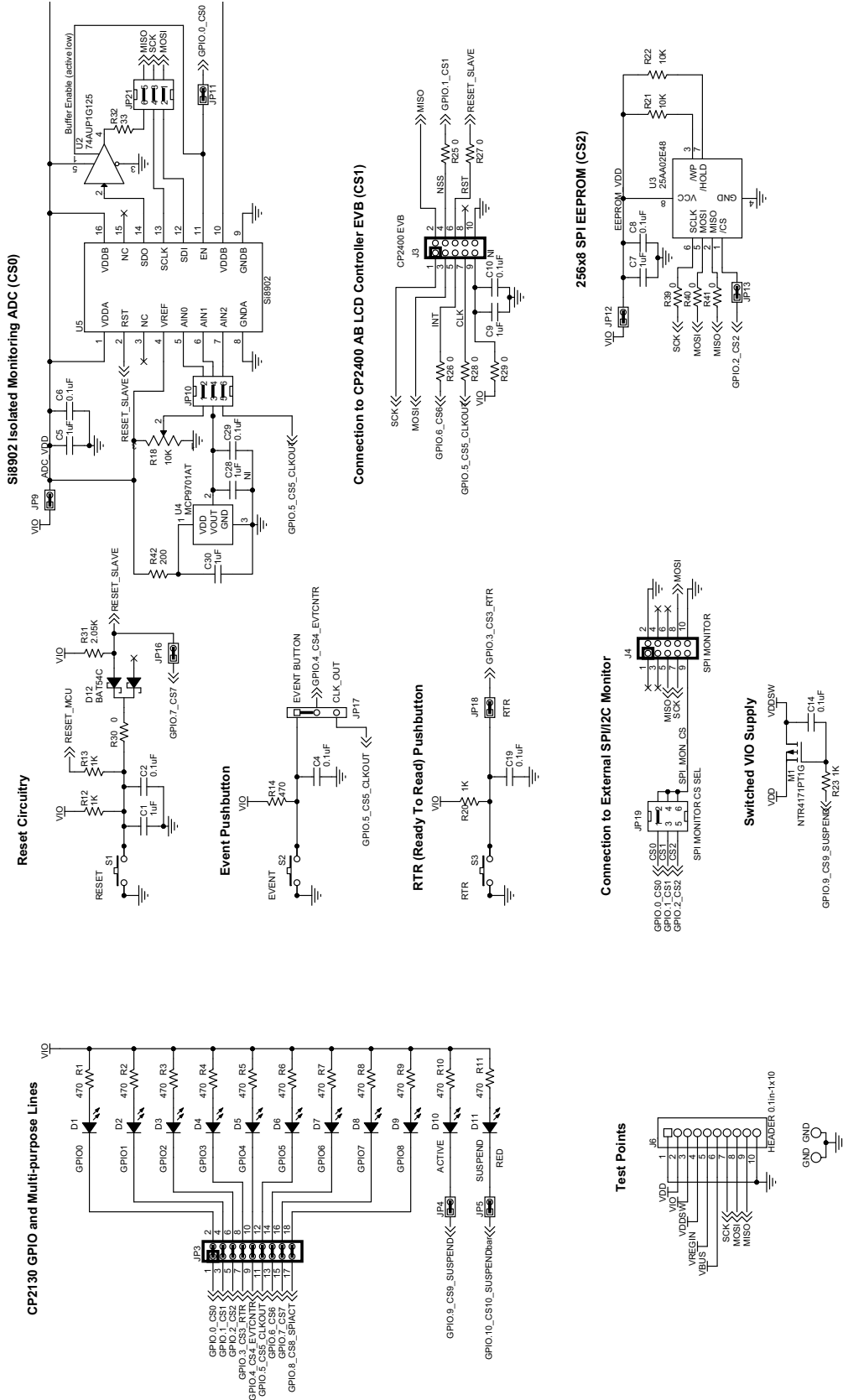

Figure 21. CP2130 Evaluation Board Schematic (2 of 2)

CP2130-EK

12. Bill of Materials

Table 18. CP2130 Evaluation Board Bill of Materials

Reference	Part Number	Source	Description
C1, C5, C7, C9, C20, C22, C24, C30	C0603X5R160-105K	Venkel	1 μ F 16 V \pm 10% X5R C0603
C2, C4, C6, C8, C10, C14, C19, C21, C23, C25, C29	C0402X7R160-104K	Venkel	0.1 μ F 16 V \pm 10% X7R C0402
C26, C27	C0603X5R6R3-475K	Venkel	4.7 μ F 6.3 V \pm 10% X5R C0603
D1, D2, D3, D4, D5, D6, D7, D8, D9, D10	SML-LX0603GW	LUMEX INC	GREEN LED-0603
D11	SML-LX0603IW	LUMEX INC	RED LED-0603
D12	BAT54C	Fairchild	BAT54C 30 V Dual, Schottky SOT23-AAK
D13	SP0503BAHTG	Littlefuse	SP0503BAHT 20 V TVS SOT143-AKKK
JP1, JP17	TSW-103-07-T-S	Samtec	HEADER 1x3 Header CONN-1X3
JP3	TSW-109-01-T-D	Samtec	Header 0.1in-2X9 Header CONN2X9
JP4, JP5, JP6, JP9, JP11, JP12, JP13, JP16, JP18, JP22	TSW-102-07-T-S	Samtec	JUMPER Header CONN1X2
JP10, JP19, JP21	TSW-103-07-T-D	Samtec	HEADER 2x3 Header CONN2X3
JS1, JS2, JS3, JS4, JS5, JS6, JS7, JS8, JS9, JS10, JS11, JS12, JS13, JS16, JS17, JS18, JS19, JS20, JS21, JS22, JS25, JS26, JS27, JS28, JS29, JS31, JS32, JS33	SNT-100-BK-T	Samtec	Jumper Shunt
J4	TSW-105-07-T-D	Samtec	HEADER 5x2 Header CONN2X5
J5	54819-0519	Molex	USB TYPE MINI B USB CON-USB5N-MINIB-54819-0519

Table 18. CP2130 Evaluation Board Bill of Materials (Continued)

Reference	Part Number	Source	Description
J6	TSW-110-07-T-S	Samtec	HEADER 0.1in-1x10 Header CONN1X10
M1	NTR4171PT1G	ON Semiconductor	NTR4171PT1G -30V P-CHNL SOT23-GSD
R1, R2, R3, R4, R5, R6, R7, R8, R9, R10, R11, R14	CR0402-16W-471J	Venkel	470 Ω \pm 5% ThickFilm R0402
R12, R13, R20, R23	CR0603-16W-102J	Venkel	1 k Ω \pm 5% ThickFilm R0603
R18	RV100F-30-4K1B-B10K-B301	Alpha (Taiwan)	10 k Ω 0.3 Thumbwheel POT-THUMB-WHEEL-10MM
R21, R22	CR0603-16W-1002F	Venkel	10 k Ω \pm 1% ThickFilm R0603
R25, R26, R27, R28, R29, R30, R39, R40, R41	CR0603-16W-000	Venkel	0 ThickFilm R0603
R31	CR0603-16W-2051F	Venkel	2.05 k Ω \pm 1% ThickFilm R0603
R32, R34, R37	CR0402-16W-330J	Venkel	33 Ω \pm 5% ThickFilm R0402
R35, R36	CR0402-16W-4702F	Venkel	47 k Ω \pm 1% ThickFilm R0402
R42	CR0603-10W-2000F	Venkel	200 Ω \pm 1% ThickFilm R0603
SF1, SF2, SF3, SF4	SJ61A6	3M	BUMPER RUBBER_FOOT_SMALL
S1, S2, S3	EVQ-PAD04M	PANASONIC CORP	MOMENTARY Tactile SW4N6.5X4.5-PB
TP2, TP3, TP4	151-207-RC	Kobiconn	RED Loop TESTPOINT
U1	CP2130-F01-GM	SiLabs	CP2130 MCU QFN24N4X4P0.5
U2	74AUP1G125GW	NXP	74AUP1G125 1.2 to 3.6 BUFFER SOT353-5N
U3	25AA02E48-I/SN	Microchip	25AA02E48 1.8 V to 5.5 V Serial SO8N6.0P1.27
U4	MCP9701AT-E/OT	MICROCHIP TECHNOLOGY INC	MCP9701AT SOT-23
U5	Si8902D-A01-GS	SiLabs	Si8902 ADC SO16N10.3P1.27
Components Not Installed			
C28	C0603X5R160-105K	Venkel	1 μ F 16 V \pm 10% X5R C0603
J3	TSW-105-07-T-D	Samtec	HEADER 5x2 Header CONN2X5
TP10, TP12, TP18	151-207-RC	Kobiconn	RED Loop TESTPOINT

Silicon Labs

Simplicity Studio™4

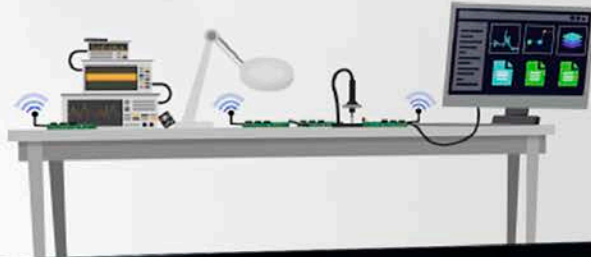

Simplicity Studio

One-click access to MCU and wireless tools, documentation, software, source code libraries & more. Available for Windows, Mac and Linux!



IoT Portfolio
www.silabs.com/IoT



SW/HW
www.silabs.com/simplicity



Quality
www.silabs.com/quality



Support and Community
community.silabs.com

Disclaimer

Silicon Labs intends to provide customers with the latest, accurate, and in-depth documentation of all peripherals and modules available for system and software implementers using or intending to use the Silicon Labs products. Characterization data, available modules and peripherals, memory sizes and memory addresses refer to each specific device, and "Typical" parameters provided can and do vary in different applications. Application examples described herein are for illustrative purposes only. Silicon Labs reserves the right to make changes without further notice and limitation to product information, specifications, and descriptions herein, and does not give warranties as to the accuracy or completeness of the included information. Silicon Labs shall have no liability for the consequences of use of the information supplied herein. This document does not imply or express copyright licenses granted hereunder to design or fabricate any integrated circuits. The products are not designed or authorized to be used within any Life Support System without the specific written consent of Silicon Labs. A "Life Support System" is any product or system intended to support or sustain life and/or health, which, if it fails, can be reasonably expected to result in significant personal injury or death. Silicon Labs products are not designed or authorized for military applications. Silicon Labs products shall under no circumstances be used in weapons of mass destruction including (but not limited to) nuclear, biological or chemical weapons, or missiles capable of delivering such weapons.

Trademark Information

Silicon Laboratories Inc.®, Silicon Laboratories®, Silicon Labs®, SiLabs® and the Silicon Labs logo®, Bluegiga®, Bluegiga Logo®, Clockbuilder®, CMEMS®, DSPPLL®, EFM®, EFM32®, EFR®, Ember®, Energy Micro, Energy Micro logo and combinations thereof, "the world's most energy friendly microcontrollers", Ember®, EZLink®, EZRadio®, EZRadioPRO®, Gecko®, ISOModem®, Precision32®, ProSLIC®, Simplicity Studio®, SiPHY®, Telegesis, the Telegesis Logo®, USBXpress® and others are trademarks or registered trademarks of Silicon Labs. ARM, CORTEX, Cortex-M3 and THUMB are trademarks or registered trademarks of ARM Holdings. Keil is a registered trademark of ARM Limited. All other products or brand names mentioned herein are trademarks of their respective holders.



Silicon Laboratories Inc.
400 West Cesar Chavez
Austin, TX 78701
USA

<http://www.silabs.com>