



GRL18S-F2331

GR18S

CYLINDRICAL PHOTOELECTRIC SENSORS

SICK
Sensor Intelligence.



Ordering information

Type	Part no.
GRL18S-F2331	1058198

Other models and accessories → www.sick.com/GR18S

Illustration may differ



Detailed technical data

Features

Sensor/ detection principle	Photoelectric retro-reflective sensor, Dual lens
Housing design (light emission)	Cylindrical
Thread diameter (housing)	M18 x 1
Optical axis	Axial
Sensing range max.	0.03 m ... 7.2 m ¹⁾
Sensing range	0.06 m ... 6 m ¹⁾
Type of light	Visible red light
Light source	PinPoint LED ²⁾
Light spot size (distance)	Ø 175 mm (7 m)
Wave length	650 nm
Adjustment	None

¹⁾ Reflector PL80A.

²⁾ Average service life: 100,000 h at T_U = +25 °C.

Mechanics/electronics

Supply voltage	10 V DC ... 30 V DC ¹⁾
Ripple	± 5 V _{pp} ²⁾
Power consumption	30 mA

¹⁾ Limit values when operated in short-circuit protected network: max. 8 A.

²⁾ May not exceed or fall below U_v tolerances.

³⁾ At U_v > 24 V or ambient temperature > 49 °C, I_A max. = 50 mA.

⁴⁾ Signal transit time with resistive load.

⁵⁾ With light/dark ratio 1:1.

⁶⁾ A = V_S connections reverse-polarity protected.

⁷⁾ B = inputs and output reverse-polarity protected.

⁸⁾ D = outputs overcurrent and short-circuit protected.

⁹⁾ At U_v ≤ 24V and I_A < 50mA.

Switching output	PNP
Switching mode	Dark switching
Signal voltage PNP HIGH/LOW	$V_S - (\leq 3 \text{ V}) / \text{approx. } 0 \text{ V}$
Output current I_{max}	100 mA ³⁾
Response time	< 500 μs ⁴⁾
Switching frequency	1,000 Hz ⁵⁾
Connection type	Connector M12, 3-pin
Circuit protection	A ⁶⁾ B ⁷⁾ D ⁸⁾
Protection class	III
Polarisation filter	✓
Housing material	Metal, Nickel-plated brass and ABS
Optics material	Plastic, PMMA
Enclosure rating	IP67
Items supplied	Fastening nuts (2 x)
EMC	EN 60947-5-2
Ambient operating temperature	-25 °C ... +55 °C ⁹⁾
Ambient storage temperature	-40 °C ... +70 °C
UL File No.	NRKH.E348498 & NRKH7.E348498

1) Limit values when operated in short-circuit protected network: max. 8 A.

2) May not exceed or fall below U_V tolerances.

3) At $U_V > 24 \text{ V}$ or ambient temperature > 49 °C, $I_A \text{ max.} = 50 \text{ mA}$.

4) Signal transit time with resistive load.

5) With light/dark ratio 1:1.

6) A = V_S connections reverse-polarity protected.

7) B = inputs and output reverse-polarity protected.

8) D = outputs overcurrent and short-circuit protected.

9) At $U_V \leq 24 \text{ V}$ and $I_A < 50 \text{ mA}$.

Classifications

ECl@ss 5.0	27270902
ECl@ss 5.1.4	27270902
ECl@ss 6.0	27270902
ECl@ss 6.2	27270902
ECl@ss 7.0	27270902
ECl@ss 8.0	27270902
ECl@ss 8.1	27270902
ECl@ss 9.0	27270902
ETIM 5.0	EC002717
ETIM 6.0	EC002717
UNSPSC 16.0901	39121528

Connection diagram

Cd-045

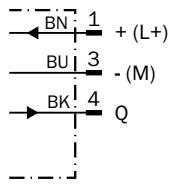

Characteristic curve

GRL18S

Operating reserve

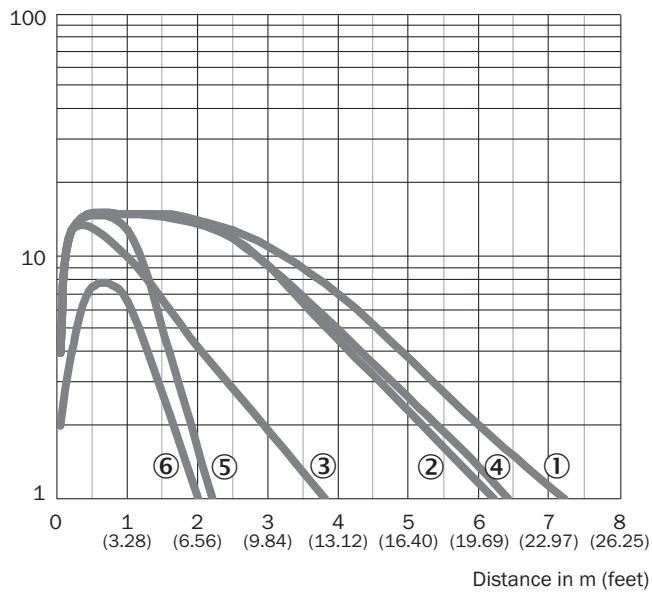

- ① Reflector PL80A
- ② Reflector PL40A
- ③ Reflector PL20A
- ④ Reflector P250
- ⑤ Reflector PL22
- ⑥ Reflective tape REF-Plus 3436

Light spot size

GRL18S

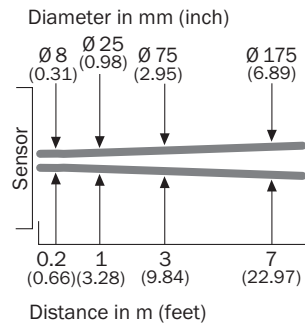

Sensing range diagram

GRL18S

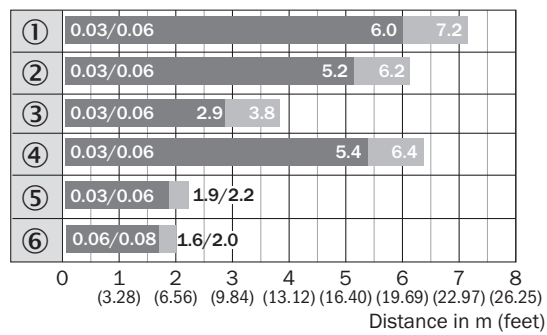

■ Sensing range ■ Sensing range max.

- ① Reflector PL80A
- ② Reflector PL40A
- ③ Reflector PL20A
- ④ Reflector P250
- ⑤ Reflector PL22
- ⑥ Reflective tape REF-Plus 3436

Dimensional drawing (Dimensions in mm (inch))

GR18S, metal, connector, straight

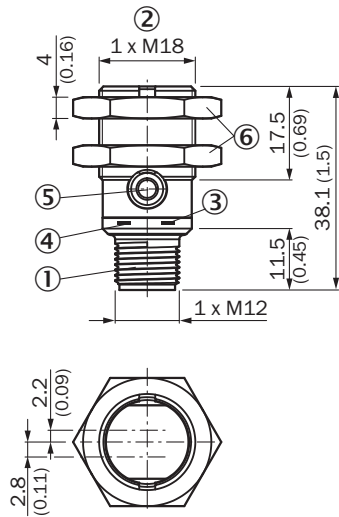









- ① Connector M12, 3-pin
- ② Threaded mounting hole M18 x 1
- ③ LED indicator yellow
- ④ LED indicator green
- ⑤ Dummy plug
- ⑥ Fastening nuts (2x); width across 24, metal

Recommended accessories

Other models and accessories → www.sick.com/GR18S

	Brief description	Type	Part no.
Plug connectors and cables			
	Head A: female connector, M12, 4-pin, straight, A-coded Head B: Flying leads Cable: Sensor/actuator cable, PVC, unshielded, 2 m	YF2A14-020VB3XLEAX	2096234
	Head A: female connector, M12, 4-pin, straight, A-coded Head B: Flying leads Cable: Sensor/actuator cable, PVC, unshielded, 5 m	YF2A14-050VB3XLEAX	2096235
	Head A: female connector, M12, 4-pin, angled, A-coded Head B: Flying leads Cable: Sensor/actuator cable, PVC, unshielded, 2 m	YG2A14-020VB3XLEAX	2095895
	Head A: female connector, M12, 4-pin, angled, A-coded Head B: Flying leads Cable: Sensor/actuator cable, PVC, unshielded, 5 m	YG2A14-050VB3XLEAX	2095897
	Head A: female connector, M12, 4-pin, straight Head B: - Cable: unshielded	DOS-1204-G	6007302
	Head A: female connector, M12, 4-pin, angled Head B: - Cable: unshielded	DOS-1204-W	6007303

	Brief description	Type	Part no.
	Head A: male connector, M12, 4-pin, straight Head B: - Cable: unshielded	STE-1204-G	6009932
	Head A: male connector, M12, 4-pin, angled Head B: - Cable: unshielded	STE-1204-W	6022084
Reflectors			
	Rectangular, screw connection, 47 mm x 47 mm, PMMA/ABS, Screw-on, 2 hole mounting	P250	5304812
	Rectangular, screw connection, 38 mm x 15 mm, PMMA/ABS, Screw-on, 2 hole mounting	PL20A	1012719
	Rectangular, screw connection, 56 mm x 28 mm, PMMA/ABS, Screw-on, 2 hole mounting	PL30A	1002314
	Rectangular, screw connection, 37 mm x 56 mm, PMMA/ABS, Screw-on, 2 hole mounting	PL40A	1012720
	Rectangular, screw connection, 80 mm x 80 mm, PMMA/ABS, Screw-on, 2 hole mounting	PL80A	1003865
	Self-adhesive	REF-IRF-56	5314244
	Round, screw connection, PMMA/ABS, Center hole mounting, screw-on	C110A	5304549

SICK AT A GLANCE

SICK is one of the leading manufacturers of intelligent sensors and sensor solutions for industrial applications. A unique range of products and services creates the perfect basis for controlling processes securely and efficiently, protecting individuals from accidents and preventing damage to the environment.

We have extensive experience in a wide range of industries and understand their processes and requirements. With intelligent sensors, we can deliver exactly what our customers need. In application centers in Europe, Asia and North America, system solutions are tested and optimized in accordance with customer specifications. All this makes us a reliable supplier and development partner.

Comprehensive services complete our offering: SICK LifeTime Services provide support throughout the machine life cycle and ensure safety and productivity.

For us, that is “Sensor Intelligence.”

WORLDWIDE PRESENCE:

Contacts and other locations –www.sick.com