

FLIR CM174**IMAGING CLAMP METER with IGMTM****TRUE RMS 600A AC/DC CLAMP METER**

Table of Contents

1.	DISCLAIMERS	4
1.1	Copyright	4
1.2	Quality Assurance	4
1.3	Documentation	4
1.4	Disposal of Electronic Waste	4
2.	SAFETY	4
3.	INTRODUCTION	7
3.1	Key Features	7
4.	METER DESCRIPTION	8
4.1	Meter Parts	8
4.2	Function Switch	9
4.3	Function Buttons	9
4.4	Display Icons and Indicators	10
4.5	Thermal Image Display	12
4.6	Clamp Meter Display	12
5.	OPERATION	13
5.1	Powering the Meter	13
5.1.1	Auto Power Off	13
5.2	Auto/Manual Range Mode	13
5.3	HOLD Mode	13
5.4	Voltage and Current Measurements	14
5.4.1	Basic Voltage Measurements	14
5.4.2	'Lo Z' Voltage Measurements	14
5.4.3	Basic Current Measurements	15
5.4.4	Extended Functionality Modes	16
5.5	Resistance Measurements	19
5.6	Continuity Test	19
5.7	Capacitance Measurements	20
5.8	Diode Test (CLASSIC mode)	21
5.9	Diode Test (SMART mode)	22
5.10	IGM Thermal Imager	23

5.10.1 Thermal Imager Basics	23
5.10.2 Programming Menu	25
5.10.3 Infrared Energy and Imaging Theory	28
6. MAINTENANCE	30
6.1 Cleaning and Storage	30
6.2 Battery Replacement	30
6.2.1 Disposal of Electronic Waste	30
7. SPECIFICATIONS	31
7.1 General specifications	31
7.2 IR Thermal Imaging Specifications	32
7.3 Electrical specifications	33
8. TECHNICAL SUPPORT	36
9. WARRANTY	37

1. Disclaimers

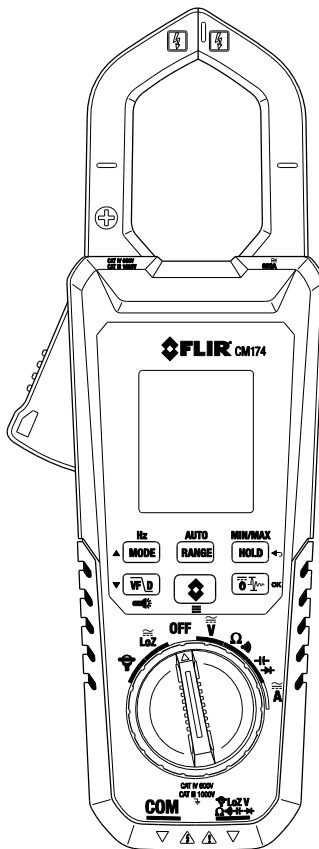
1.1 Copyright

© 2015-2017, FLIR Systems, Inc., All rights reserved worldwide. No parts of the software including source code may be reproduced, transmitted, transcribed or translated into any language or computer language in any form or by any means, electronic, magnetic, optical, manual or otherwise, without the prior written permission of FLIR Systems.

The documentation must not, in whole or part, be copied, photocopied, reproduced, translated or transmitted to any electronic medium or machine readable form without prior consent, in writing, from FLIR Systems.

Names and marks appearing on the products herein are either registered trademarks or trademarks of FLIR Systems and/or its subsidiaries. All other trademarks, trade names or company names referenced herein are used for identification only and are the property of their respective owners.

1.2 Quality Assurance

The Quality Management System under which these products are developed and manufactured has been certified in accordance with the ISO 9001 standard.

FLIR Systems is committed to a policy of continuous development; therefore we reserve the right to make changes and improvements on any of the products without prior notice.

1.3 Documentation

To access the latest manuals and notifications, go to the Download tab at:

<http://support.flir.com>. It only takes a few minutes to register online. In the download area you will also find the latest releases of manuals for our other products, as well as manuals for our historical and obsolete products.

1.4 Disposal of Electronic Waste



As with most electronic products, this equipment must be disposed of in an environmentally friendly way, and in accordance with existing regulations for electronic waste.

 Please contact your FLIR Systems representative for more details.

2. Safety

Safety Notes

- Before operating the device, you must read, understand, and follow all instructions, dangers, warnings, cautions, and notes.
- FLIR Systems reserves the right to discontinue models, parts or accessories, and other items, or to change specifications at any time without prior notice.
- Remove the batteries if the device is not used for an extended period of time.



Warning Statements

- Do not operate the device if you do not have the correct knowledge. Formal qualifications and/or national legislation for the electrical inspections can apply. Incorrect operation of the device can cause damage, shock, injury or death to persons.
- Do not start the measuring procedure before you have set the function switch to the correct position. This can cause damage to the instrument and can cause injury to persons.
- Do not change to current or resistance when you measure the voltage. This can cause damage to the instrument and can cause injury to persons.
- Do not measure the current on a circuit when the voltage increases to more than 1000 V. This can cause damage to the instrument and can cause injury to persons.
- You must disconnect the test leads from the circuit that you did a test on before you change the range. If you do not do this, damage to the instrument and injury to persons can occur.
- Do not replace the batteries before you remove the test leads. This can cause damage to the instrument and can cause injury to persons.
- Do not use the device if the test leads and/or the device show signs of damage. Injury to persons can occur.
- Be careful when taking measurements if the voltages are more than 25 VAC rms or 35 VDC. There is a risk of shock from these voltages. Injury to persons can occur.
- Do not do diode, resistance or continuity tests before you have removed the power from capacitors and other devices under test during a measurement. Injury to persons can occur.
- Make sure that children cannot touch the device. The device contains dangerous objects and small parts that children can swallow. If a child swallows an object or a part, speak with a physician immediately. Injury to persons can occur.
- Do not let children play with the batteries and/or the packing material. These can be dangerous for children if they use them as toys.
- Do not touch expired or damaged batteries without gloves. Injury to persons can occur.
- Do not cause a short circuit of the batteries. This can cause damage to the instrument and can cause injury to persons.
- Do not put the batteries into a fire. Injury to persons can occur.

Cautions

Do not use the device for a procedure that it is not intended for. This can cause damage to the protection.

	This symbol, adjacent to another symbol or terminal, indicates that the user must refer to the manual for further information.
	This symbol, adjacent to a terminal, indicates that, under normal use, hazardous voltages may be present.
	Double insulation.



UL listing is not an indication or a verification of the accuracy of the meter



IEC 60825-1 Ed. 2 (2007)

CAUTION: Use of controls or adjustments or performance of procedures other than those specified herein may result in hazardous radiation exposure.

Agency Approvals



3. Introduction

Thank you for selecting the FLIR CM174 Clamp Meter. The CM174 is a True RMS 600A AC/DC clamp meter with radiometric Lepton Thermal Imaging system, integrated VFD Mode, Inrush Current capture and a Lo Z mode for eliminating 'ghost' voltages. This device is shipped fully tested and calibrated and, with proper use, will provide years of reliable service.

3.1 Key Features

- 6000-count color TFT display
- IGMTM (Infrared Guided Measurement) Thermal Imaging System
- Work lights
- Auto Range True RMS AC/DC 600 A capability
- Auto Range True RMS AC/DC 1000 V capability
- Frequency AC bandwidth (45-400Hz)
- Frequency Measurements to 60KHz
- Flex Clamp adaptor input for FLIR TA72_TA74 Clamp adaptors
- Resistance and Continuity measurements
- Capacitance and Diode measurements
- Data HOLD
- Inrush current
- DCA zero function
- Low Z (Impedance) mode
- Minimum/Maximum memory
- Integrated VFD mode (Low-pass filter)
- Auto power off (can be deactivated or preset to 1, 2, 5, or 10 minutes)
- Jaw opening 35mm (1.38")
- Easy-access battery cover mechanism
- Safety Category Rating: CAT IV-600V, CAT III-1000V

4. Meter Description

4.1 Meter Parts

1. Jaw opening trigger
2. MODE/HZ/up arrow button
3. VFD/Work light/down arrow button
4. Function switch
5. COM (negative -) Probe Input jack
6. Positive (+) Probe Input jack
7. IGM Thermal Image mode button
8. DCA Zero/Inrush/OK button
9. MIN/MAX HOLD button
10. AUTO/RANGE Button
11. Color TFT Display
12. Clamp jaw

Fig 4-1 Front View

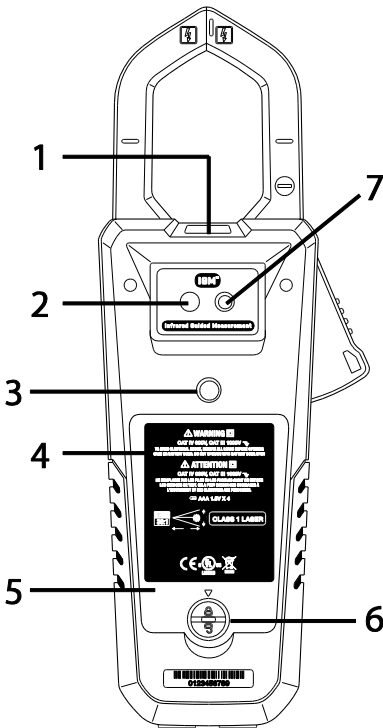
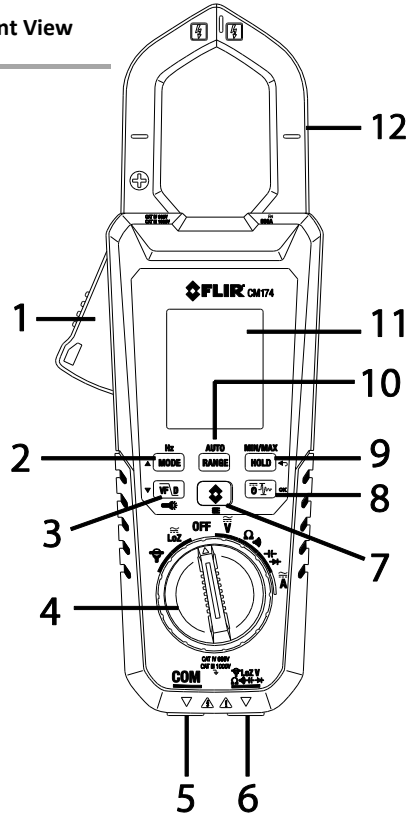













Fig 4-2 Rear View

1. Work light
2. Thermal imaging lens
3. Tripod mount
4. Warning & informational text
5. Battery compartment
6. Battery compartment lock
7. Laser pointer lens

4.2 Function Switch



















	Select this position when connecting a FLIR Flex Clamp Adaptor.
	Select this position to measure in the low impedance mode.
OFF	Select this position to switch the meter OFF (full power saving mode).
	Select this position to measure AC/DC Voltage through the probe inputs.
	The meter can measure resistance and continuity through the probe inputs. The type of measurement is selected by the MODE button.
	The meter can measure capacitance and diode through the probe inputs. The type of measurement is selected by the MODE button.
	Amps AC/DC. The meter can measure current through the clamp jaws.







4.3 Function Buttons

	Select AC or DC in the Voltage/Current modes. Select Diode or Capacitance; Continuity or Resistance. Select Hz in AC Voltage, Current, or FLEX modes. Use 'up' arrow in menus.
	Select Auto or Manual range mode, see section 5.3 Auto/Manual range mode In Manual mode, press to change the range (scale); to return to Auto range mode from Manual mode, press and hold for > 2 seconds.
	Toggle normal and Data Hold modes, see section 5.4 Hold mode Press for > 2 seconds to activate/deactivate MIN/MAX mode. Use as RETURN/BACK button in menus.
	Press to activate/deactivate VFD mode. Press and hold for > 2 seconds to switch the Work Light ON/OFF. Use 'down' arrow in menus.
	Press to enter or exit the IGM Thermal Image mode. Press and hold for > 2 seconds to access the Programming Menu.

	<p>In the DCA mode, press to zero the display. In the ACA mode press to activate or deactivate inrush current mode. Use to confirm (OK) menu items.</p>
---	---

4.4 Display Icons and Indicators

	<p>Indicates that the meter is displaying maximum reading values.</p>
	<p>Indicates that the meter is displaying minimum reading values.</p>
	<p>Indicates that the meter is in Auto range mode.</p>
	<p>Indicates that the meter is in Hold mode.</p>
	<p>Indicates the battery voltage status.</p>
	<p>Indicates that the auto power off function is enabled.</p>
	<p>Indicates that the measured voltage is greater than 30 V DC or AC RMS.</p>
	<p>Indicates that the meter is measuring AC current or voltage.</p>
	<p>Indicates that meter is measuring DC current or voltage.</p>
	<p>Indicates that the continuity function is active.</p>
	<p>Indicates that the diode test function is active.</p>
	<p>Ohm symbol. Unit of measure for Resistance and Continuity.</p>
	<p>Unit of measure for current (Amps or Amperes).</p>
	<p>Volt. Unit of measure for Voltage.</p>
	<p>Farad. Unit of measure for Capacitance.</p>
	<p>Hertz. Unit of measure for Frequency.</p>
	<p>103 (kilo)</p>
	<p>10-3 (milli)</p>

	10-6 (micro)
	VFD mode icon.
	DC Zero mode icon.
	Inrush current mode icon.
	FLEX Clamp Adaptor (FLIR TA72_TA74) icon.
	100mV/Ampere Clamp Adaptor icon.
LoZ	Lo Z mode icon.
ϵ	Emissivity
	Bargraph
OL	Out of Range warning

4.5 Thermal Image Display

Press the IGM button to open the Thermal Imager. Refer to Section 5.9 for detailed instructions on the IR Thermal Imager functions. Note the clamp meter display information in the thermal image example screen Fig. 4-3.

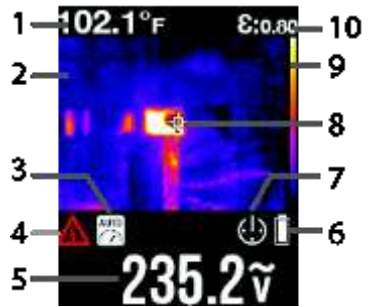

Fig 4-3 Thermal Image

1. Temperature Measurement*
2. Thermal Image
3. Auto Range icon
4. High Voltage alert
5. Voltage reading
6. Battery status
7. Auto Power OFF active
8. Cross hairs
9. Palette scale
10. Emissivity setting

*Temperature display area shows dashes while the reading is stabilizing.

4.6 Clamp Meter Display

1. High Voltage alert
2. MAX reading
3. Digital representation of measurement
4. Bargraph representation of measurement
5. Clamp Adaptor icon
6. Low Pass Filter icon (VFD mode)
7. Inrush Current mode
8. DCA Zero mode icon
9. Unit of measure
10. MIN reading
11. Battery status
12. Auto Power OFF (APO)
13. Data Hold icon
14. Auto Range icon

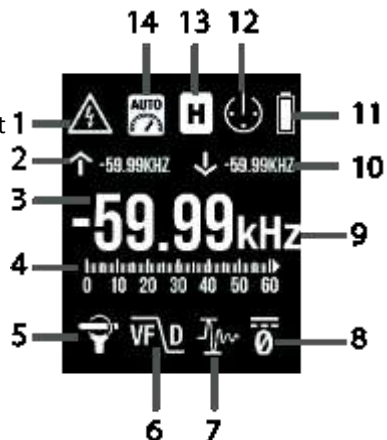

Fig 4-4 Clamp Meter Display

5. Operation

Note: Before operating the device, please read, understand, and follow all instructions, dangers, warnings, cautions, and notes.

Note: When the meter is not in use, the function switch should be set to the OFF position.

Note: When connecting the probe leads to the device under test, connect the negative lead before connecting the positive lead. When removing the probe leads, remove the positive lead before removing the negative lead.

5.1 Powering the Meter

1. Set the function switch to any position to switch the meter ON.
2. If the battery indicator  shows that the battery voltage is low or if the meter does not power on, replace the batteries. See section [6.2 Battery replacement](#).

5.1.1 Auto Power Off

The meter enters sleep mode after 10 minutes of inactivity. The meter beeps three times before powering off. Press any button or turn the function switch to prevent the meter from powering off. The auto power off time-out is then reset. Deactivate APO (or set the APO timer) using the Programming Menu (refer to Section 5.10.2 Programming Menu). The APO icon  is displayed when APO is active.

5.2 Auto/Manual Range Mode

In Auto range mode, the meter automatically selects the most appropriate measurement scale. In Manual range mode, the desired range (scale) can be set manually.

Auto range mode is the default mode of operation. When a new function is selected with

the function switch, the starting mode is Auto range and the  indicator is displayed.

To enter Manual range mode, press the RANGE button. To change the range, press the RANGE button repeatedly until the desired range is displayed.

To return to Auto range mode from Manual mode, press and hold the RANGE button until the  indicator is displayed.

5.3 HOLD Mode

- In Hold mode, the display freezes the last reading and continues to display this value.
- Use the HOLD button to toggle between Normal and Hold modes. In Hold mode, the  indicator is displayed.

5.4 Voltage and Current Measurements

Note: If the measured voltage is greater than 30 V DC or AC RMS, the  indicator is displayed.

5.4.1 Basic Voltage Measurements

1. Set the function switch to the V position.
2. To manually select AC or DC, press the MODE button.
3. To manually select the measurement range (scale), press the RANGE button repeatedly. Refer to section [5.2 Auto/Manual range mode](#).
4. Insert the black probe lead into the negative COM terminal and the red probe lead into the positive V terminal.
5. Connect the probe leads in parallel to the part under test.
6. Read the voltage value on the display.

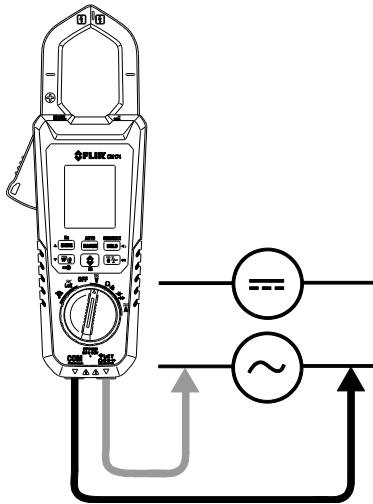



Figure 5.1 Voltage Measurements

5.4.2 'Lo Z' Voltage Measurements

When the function switch is turned to the  position, the meter incorporates a low impedance circuit that eliminates ghost voltages. The low impedance is approx. 2.5k Ω . To take voltage measurements in the Lo Z mode, select the  function switch position and follow the voltage measurement instructions in the previous section.

5.4.3 Basic Current Measurements

⚠ WARNING Do not measure the current on a circuit when the voltage increases to more than 1000V. This can cause damage to the instrument and can cause injury to persons.

When measuring current using the clamp jaws, only one conductor should be enclosed by the jaws—refer to Figure 5.2.

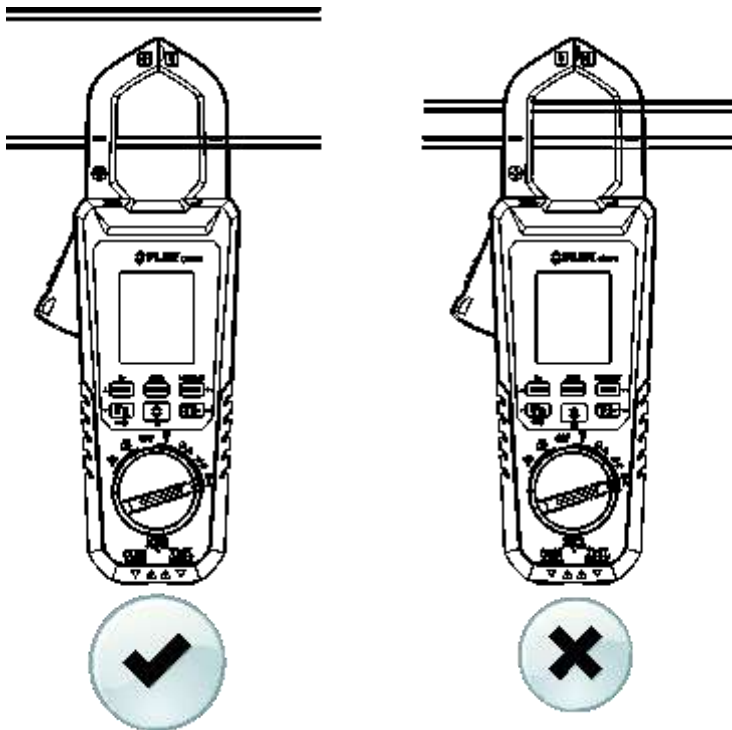

Figure 5.2 Correct and incorrect setup

1. Ensure that the probe leads are disconnected from the meter.
2. Set the function switch to the A position.
3. To manually select AC or DC use the MODE button.
4. To manually select the measurement range (scale), press the RANGE button repeatedly. Refer to section [5.3 Auto/Manual range mode](#).
5. Press the trigger to open the clamp jaws. Fully enclose one conductor—refer to Figure [5.2](#). For optimum results, center the conductor in the jaws.
6. Read the current value on the display.

5.4.4 Extended Functionality Modes

In addition to the basic measurements that the CM174 can perform, a variety of extended functions are included. Refer to the following sections for details.

5.4.4.1 Inrush Current Mode

In Inrush current mode, the meter displays the AC RMS current reading in the first 100ms period after the trigger point (current detection threshold) is reached, see Fig. 5.3 below. The current detection threshold is 0.5A for the 60.00A range and 5.0A for the 600.0A range. Inrush current mode is available when measuring AC current.

1. Connect the meter to the unpowered circuit under test
2. Set the meter to A
3. Press the Inrush button  to enable the Inrush current mode. The Inrush display icon will appear on the LCD.
4. Turn on the power to the circuit under test
5. When the threshold is reached, the meter will display the RMS reading for the 100ms integration time.

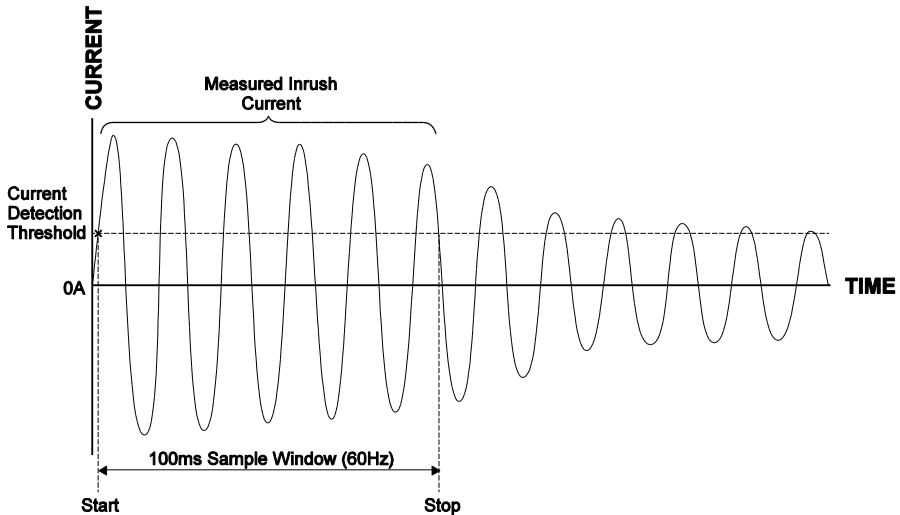



Figure 5.3 Inrush Current

5.4.4.2 DCA Zero Mode

The DC zero feature removes offset values and improves DC Current accuracy.

1. Set the meter to measure DCA. Ensure that there is no conductor in the clamp jaws.
2. Press the DCA Zero button  to enable DC Zero. The display will zero.
3. Take DC current measurements as explained in the Current Measurements section.

5.4.4.3 Frequency Mode



In Frequency mode, the meter measures and displays the frequency. Frequency mode is available when measuring AC current or voltage.

Important note: Do not switch to the Frequency mode until the meter is setup and actively measuring the voltage or current signal.

Press and hold the MODE button to select **Hz** and enable Frequency mode.

5.4.4.4 MIN/MAX Mode

In MIN/MAX mode, the meter captures and displays the Minimum and Maximum readings and updates only when a higher/lower value is registered.

1. Press and hold the MIN/MAX button to access the MIN/MAX mode.
2. The down arrow  will appear and the reading displayed next to it will represent the lowest reading encountered since the MIN/MAX button was first pressed.
3. The up arrow  will also appear and the reading displayed next to it will represent the highest reading encountered since the MIN/MAX button was first pressed.
4. The meter will continue to display the real time measurement value in the normal display area.
5. Press and hold the MIN/MAX button for 2 seconds to exit the MIN/MAX mode. The meter will return to normal operation and the MIN/MAX memories will be reset.

5.4.4.5 VFD Mode (low pass filter)

The VFD mode eliminates high frequency noise in AC voltage measurements by means of a low-pass filter. The VFD mode is designed for such applications as variable frequency drives (VFD) and inverters. Press the VFD button to activate or deactivate the VFD mode.

The VFD display icon is displayed  when the mode is active.

5.4.4.6 Flex Clamp Adaptor Use

FLIR Clamp Adaptors (Models TA72 and TA74) can be connected to the CM174 to display current measurements made by the Flex Clamp Adaptor.

1. Turn the function dial to the  position.
2. Connect the Flex Clamp as shown.
3. Set the range of the Flex Clamp adaptor to match the range of the CM174. For convenience, the CM174 will display the range setting (100mv/A).
4. Operate the Flex Clamp per instructions provided with the Flex Clamp meter.
5. Read the current measured by the Flex Clamp on the display.

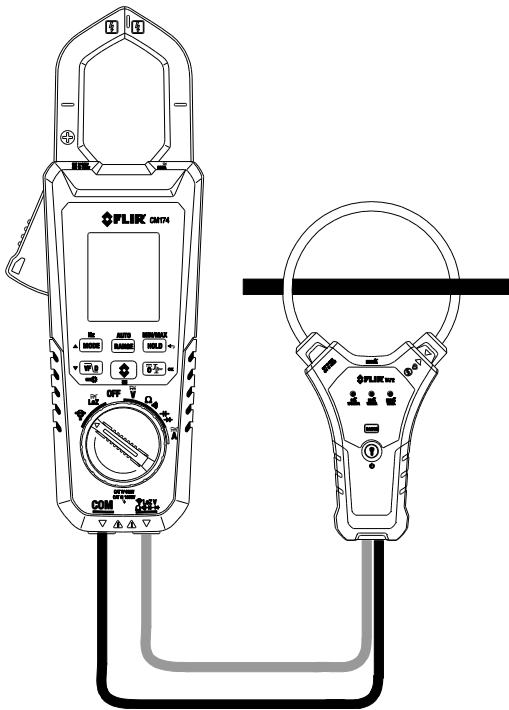

Figure 5.4 Connecting a FLIR Flex Clamp Adaptor

5.5 Resistance Measurements

Warning: Do not perform resistance tests before removing the power from resistors and other devices under test during a measurement. Injury to persons can occur.

1. Set the function switch to the Ω position.
2. Use the MODE button to select the resistance mode (continuity symbol ⦿) should be OFF).
3. Insert the black probe lead into the negative COM terminal and the red probe lead into the positive Ω terminal.
4. Touch the tips of the probe across the circuit or component under test.
5. Read the resistance value on the display.

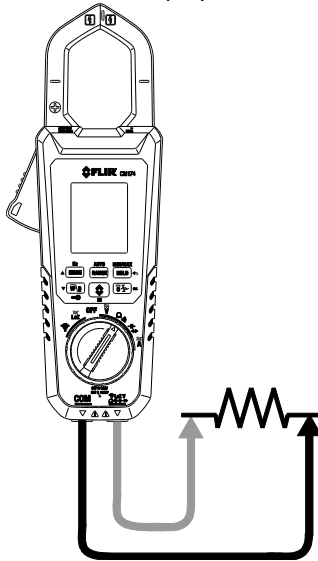

Figure 5.5 Resistance and Continuity Measurements

5.6 Continuity Test

Warning: Do not perform continuity tests before removing the power to the component, circuit, or other device under test during a measurement. Injury to persons can occur.

1. Set the function switch to the ⦿ position.
2. Insert the black probe lead into the negative COM terminal and the red probe lead into the positive Ω terminal. Refer to Fig. 5-5 for connection example.
3. Use the MODE button to select continuity measurement. The ⦿ indicator will be displayed.
4. Touch the tips of the probe across the circuit or component under test.
5. If the resistance is lower than 30 Ω , the meter will beep.

5.7 Capacitance Measurements

Warning: Do not perform capacitance tests before removing the power to the capacitor or to other devices under test during a measurement. Injury to persons can occur.

1. Set the function switch to the M position.
2. Use the MODE button to select capacitance function (capacitor symbol must be displayed).
3. Insert the black probe lead into the negative COM terminal and the red probe lead into the positive M terminal.
4. Touch the tips of the probe across the part under test.
5. Read the capacitance value on the display.

Note: For very large capacitance values, several seconds may be required for the measurement to settle and for the final reading to stabilize.

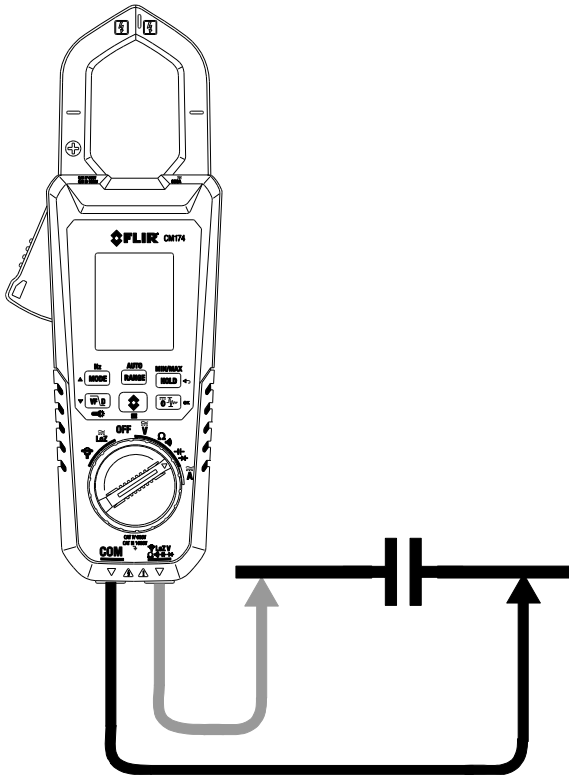

Figure 5.6 Capacitance Measurements

5.8 Diode Test (CLASSIC mode)

Warning: Do not perform diode tests before removing the power to the diode or other devices under test during a measurement. Injury to persons can occur.

1. If not already selected, choose CLASSIC Diode test mode in the Programming Menu (See Section 5.10.2).
2. Set the function switch to the diode $\rightarrow+$ position.
3. Insert the black probe lead into the negative COM terminal and the red probe lead into the positive Ω terminal.
4. Use the MODE button to select the diode test function. The diode indicator $\rightarrow+$ will be displayed.
5. Touch the tips of the probe across the diode or semiconductor junction under test.
6. For Classic Diode mode: If the reading is between 0.40 and 0.80V in one direction and OL (overload) in the opposite direction, the component is good. If the measurement is 0V in both directions (shorted) or OL in both directions (open), the component is bad.

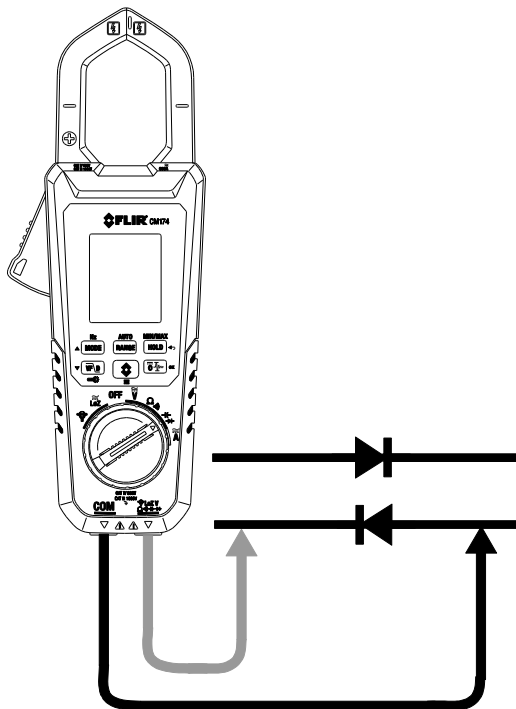

Figure 5.7 Diode Testing

5.9 Diode Test (SMART mode)

Warning: Do not perform diode tests before removing the power from capacitors and other devices under test during a measurement. Injury to persons can occur.

1. If not already selected, choose SMART Diode test mode in the Programming Menu (See Section 5.10.2).
2. Set the function switch to the diode $\rightarrow+$ position.
3. Insert the black probe lead into the negative COM terminal and the red probe lead into the positive Ω terminal.
4. Use the MODE button to select the diode test function. The diode indicator $\rightarrow+$ will be displayed.
5. Touch the tips of the probe across the diode or semiconductor junction under test.
6. If the reading is between ± 0.40 and $+0.80V$, the component is good; BAD or O.L displays indicate a defective component.

In SMART Diode mode the CM174 checks diodes using an alternating test signal sent through the diode in both directions. This allows the user to check the diode without having to reverse polarity manually. The meter display will show $\pm 0.4 \sim 0.7V$ for a good diode, BAD for a shorted diode, and O.L for an opened diode. See Fig. 5.7 below:

Figure 5.7 Diode Test in the SMART mode

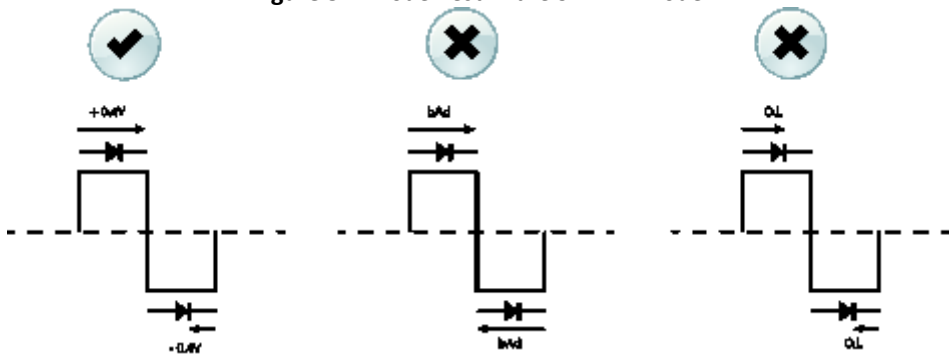

5.10 IGM Thermal Imager

Warning: Do not point the laser toward the eyes, as prolonged exposure may cause injury.

5.10.1 Thermal Imager Basics

In the Thermal Imaging mode the user can measure a targeted surface's temperature. This is accomplished by detecting the energy emitted by the surface under test. A thermal image of the area under test is viewed in the same manner as with dedicated thermal imaging devices, where color variations reflect temperature variations. See Section 5.10.3 for an in-depth discussion on Infrared Energy and Thermal Imaging Theory. The laser pointer and display cross hairs assist in surface targeting.

- **Press the IGM button to open the Thermal Imager.** In Fig 5-8 the meter is set to color palette IRON. Select other palettes in the Programming Menu.

1. Temperature Measurement
2. Thermal Image
3. Auto Range icon
4. High Voltage alert
5. Voltage reading
6. Battery status
7. Auto Power OFF active
8. Cross hairs
9. Palette scale
10. Emissivity setting

Fig 5-8 Thermal Image

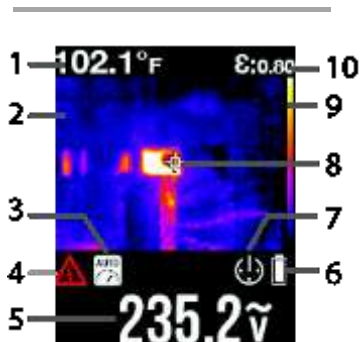

- **The Temperature measurement** (1) shown on the upper left corner of the display represents the temperature of the spot sensed. Note that while the temperature reading is stabilizing dashes will be displayed for approximately 30 seconds. The Laser and the Cross hairs (8) can be used for precise targeting (set them ON or OFF individually in the Programming Menu).
- The currently selected **Emissivity** value (10) is shown on the upper right corner. Use the programming Menu to change the emissivity setting. See the Emissivity table later in this guide for a list of settings for various surface textures.
- The **Thermal scale** (9) shows the range of colors for thermal images. The lighter the color, the warmer the temperature; the darker the color, the cooler the temperature.
- The **Distance to Spot ratio** for the imager is 30:1 meaning that the measurement spot is 30 times smaller than the distance the meter is from spot (at a distance of 30", the meter 'sees' a target spot of 1"). See Fig 5-8 for examples. The thermal imager's FOV (Field Of View) is 50 degrees (top view) and 38.6 degrees (side view), see Fig. 5-9 (a) and (b).

To customize the Thermal Imager use the programming menu as described in Section 5.10.2. For basic operation follow these steps:

1. Set the function switch to any position.
2. Press the IGM button for < 1 second to switch the IGM Thermal Imager ON. Point the thermal imaging lens (located on the rear of the meter) toward an area to measure.
3. The display will show the temperature measurement in the upper left hand corner for the targeted area and the currently selected emissivity value on the upper right hand corner.
4. In the Thermal Imaging mode, the laser pointer and display cross hairs can be used to assist in targeting. These tools can be switched ON or OFF in the Programming Menu.
5. In the Thermal imaging mode, the meter continues to operate normally as a clamp meter allowing any of the electrical functions to be used. Note that in the Thermal Imaging mode the electrical functions are shown on the lower portion of the display beneath the thermal image (see Fig. 5-8).

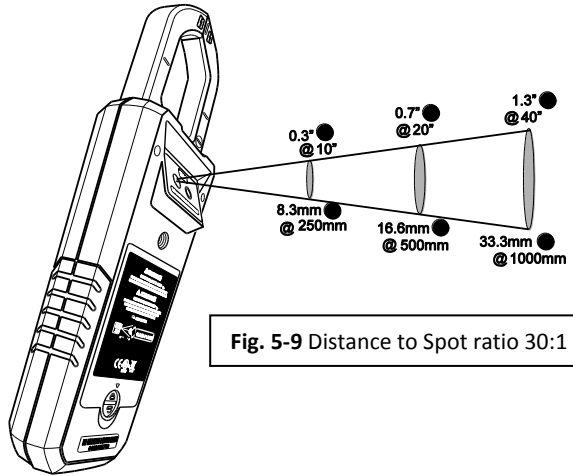

Fig. 5-9 Distance to Spot ratio 30:1

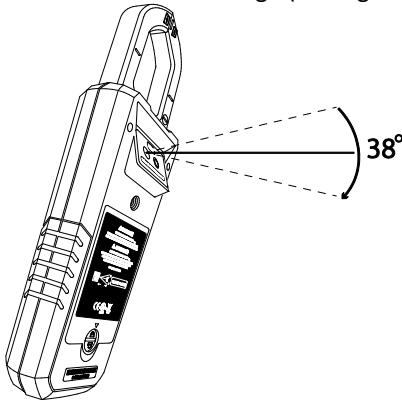

Fig. 5-10 (a) Field of View – side view

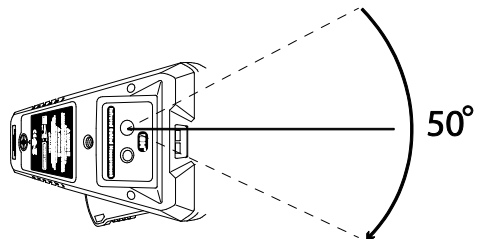

Fig. 5-10 (b) Field of View - top view

5.10.2 Programming Menu









1. To access the programming menu, set the function switch to any position to switch the meter on, and then press and hold the IGM button for > 3 seconds. The menu should now show a display, similar to the one in Fig. 5-11.



Figure 5.11 Programming menu example

2. The menu icons are located on the left side of the display and their settings are shown on the right side. Use the up and down arrow buttons to scroll the parameter list.
3. When a parameter is highlighted, press the OK button to either toggle the setting (if it is a parameter with two options: Laser ON/OFF, Temperature units C/F, Cross hairs ON/OFF, Diode mode SMART/CLASSIC) or to open the parameter for editing (for parameters with 3 or more selection options: Color Palette, Emissivity, APO). For details on each, refer to the following paragraphs.
4. Once programming is complete, press the IGM button momentarily to exit the thermal imaging mode.

Figure 5.12 Programming menu ICON descriptions

Icon	Description	Options
	Color Palette	Rainbow, Iron, and Gray scale
	Emissivity	Presets: 0.30, 0.60, 0.80, 0.95 (and custom)
	Laser pointer	ON or OFF
	Temp. units	oC or oF
	Cross hairs	ON or OFF
	Diode modes	CLASSIC or SMART mode
	Auto Power OFF	OFF, 1, 2, 5, or 10 minutes
	Help Screen	Contact and other useful information
	Information	Firmware version, last calibration date, & laser information



Color Palette

1. Press and hold the IGM button to access the Programming menu.
2. Scroll to the color palette icon using the arrow buttons
3. Use the OK button to step through the three color scheme options (rainbow, iron, and gray scale).
4. When the desired selection is made, use the arrow keys to continue scrolling the programming menu or press the return button to exit the programming menu.



Emissivity

1. Press and hold the IGM button to access the Programming menu.
2. Scroll to the emissivity icon using the arrow buttons
3. Use the OK button to open the emissivity screen.
4. Use the arrow buttons to step through the presets (0.30, 0.60, 0.80, and 0.95) and the custom selector.
5. Press the OK button to select a preset (the circle will switch to the color blue).
6. To use the custom mode, press OK when the custom icon is highlighted and use the arrow buttons to select a specific emissivity setting. Press OK when the desired value is set; the blue dot will now be to the right of the custom setting.
7. For a table showing the emissivity factors for common materials see Section 5.10.4
8. Press the Return button to return to the programming menu.



Laser Pointer

1. Press and hold the IGM button to access the Programming menu.
2. Scroll to the Laser icon using the arrow buttons.
3. Use the OK button to toggle the Laser ON or OFF.
4. When done, use the arrow buttons to continuing scrolling the Programming menu or use the Return button to exit the programming menu.



Temperature units

1. Press and hold the IGM button to access the Programming menu.
2. Scroll to the Temperature unit icon using the arrow buttons.
3. Use the OK button to toggle C and F units.
4. When done, use the arrow buttons to continuing scrolling the Programming menu or use the Return button to exit the programming menu.



Cross hairs

1. Press and hold the IGM button to access the Programming menu.
2. Scroll to the Cross hairs icon using the arrow buttons.
3. Use the OK button to toggle the Cross hairs ON and OFF.
4. When done, use the arrow buttons to continuing scrolling the Programming menu or use the Return button to exit the programming menu.



Diode mode

1. Press and hold the IGM button to access the Programming menu.
2. Scroll to the Diode symbol using the arrow buttons.
3. Use the OK button to toggle CLASSIC and SMART modes.
4. When done, use the arrow buttons to continuing scrolling the Programming menu or use the Return button to exit the programming menu.



Auto Power OFF mode

1. Press and hold the IGM button to access the Programming menu.
2. Scroll to the APO icon using the arrow buttons
3. Use the OK button to open the APO screen.
4. Use the arrow buttons to step through the presets (OFF, 1, 2, 5, 10 minutes).
5. Press the OK button to select a highlighted preset (the circle will switch to the color blue).
6. Press the Return button to return to the programming menu.
7. ? Help screen
8. Press and hold the IGM button to access the Programming menu.
9. Scroll to the Help (?) icon using the arrow buttons.
10. Press the OK button to view contact and other information.
11. Use the Return button to return to the Programming menu.



Information screen

1. Press and hold the IGM button to access the Programming menu.
2. Scroll to the information icon using the arrow buttons.
3. Press the OK button.
4. View the firmware version and the last calibration date.
5. Use the Return button to return to the Programming menu.

5.10.3 Infrared Energy and Imaging Theory

A thermal imager generates an image based on temperature differences. In a thermal image the hottest item in the scene appears as white and the coldest item as black, and all other items are represented as a gray scale value between white and black.

It may take some time to get used to the thermal imagery. Having a basic understanding of the differences between thermal and daylight cameras can help with getting the best performance from the CM174.

One difference between thermal and daylight cameras has to do with where the energy comes from to create an image. When viewing an image with an ordinary camera, there has to be some source of visible light (something hot, such as the sun or lights) that reflects off of the objects in the scene to the camera. The same is true with human eyesight; the vast majority of what people see is based on reflected light energy. On the other hand, the thermal imager detects energy that is directly radiated from objects in the scene.

This is why hot objects such as parts on an engine and exhaust pipes appear white, while the sky, puddles of water and other cold objects appear dark (or cool). Scenes with familiar objects will be easy to interpret with some experience.

Infrared energy is part of a complete range of radiation called the electromagnetic spectrum. The electromagnetic spectrum includes gamma rays, X-rays, ultraviolet, visible, infrared, microwaves (RADAR), and radio waves. The only difference is their wavelength or frequency. All of these forms of radiation travel at the speed of light. Infrared radiation lies between the visible and RADAR portions of the electromagnetic spectrum.

The primary source of infrared radiation is heat or thermal radiation. Any object which has a temperature radiates in the infrared portion of the electromagnetic spectrum. Even objects that are very cold, such as an ice cube, emit infrared. When an object is not quite hot enough to radiate visible light, it will emit most of its energy in the infrared. For example, hot charcoal may not give off light, but it does emit infrared radiation, which we feel as heat. The warmer the object, the more infrared radiation it emits.

Infrared imaging devices produce an image of invisible infrared or “heat” radiation that is unseen by the human eye. There are no colors or “shades” of gray in infrared, only varying intensities of radiated energy. The infrared imager converts this energy into an image that we can interpret.

The Infrared Training center offers training (including online training) and certification in all aspects of thermography: <http://www.infraredtraining.com/>.

5.10.4 Emissivity Factors for Common Materials

Material	Emissivity	Material	Emissivity
Asphalt	0.90 to 0.98	Cloth (black)	0.98
Concrete	0.94	Skin (human)	0.98
Cement	0.96	Leather	0.75 to 0.80
Sand	0.90	Charcoal (powder)	0.96
Soil	0.92 to 0.96	Lacquer	0.80 to 0.95
Water	0.92 to 0.96	Lacquer (matt)	0.97
Ice	0.96 to 0.98	Rubber (black)	0.94
Snow	0.83	Plastic	0.85 to 0.95
Glass	0.90 to 0.95	Timber	0.90
Ceramic	0.90 to 0.94	Paper	0.70 to 0.94
Marble	0.94	Chromium Oxides	0.81
Plaster	0.80 to 0.90	Copper Oxides	0.78
Mortar	0.89 to 0.91	Iron Oxides	0.78 to 0.82
Brick	0.93 to 0.96	Textiles	0.90

5.10.5 Non-Uniformity Correction

A non-uniformity correction (or NUC) is an image correction carried out by the camera software to compensate for different sensitivities of detector elements and other optical and geometrical disturbances¹.

The NUC is an automatic function that takes place periodically (approximately every 2-3 minutes) or whenever the inner core of the camera detects a $\pm 20^{\circ}\text{C}$ temperature change.

1. Definition from the imminent international adoption of DIN 54190-3 (Non-destructive testing – Thermographic testing – Part 3: Terms and definitions).

6. Maintenance

6.1 Cleaning and Storage

Clean the meter with a damp cloth and mild detergent; do not use abrasives or solvents.

If the meter is not to be used for an extended period, remove the batteries and store them separately.

6.2 Battery Replacement

1. To avoid electrical shock, disconnect the meter if connected to a circuit, remove the probe leads from the terminals, and set the function switch to the OFF position before attempting to replace the batteries.
2. Unlock and remove the battery compartment cover.
3. Replace the four (4) standard AAA batteries, observing correct polarity.
4. Secure the battery compartment cover.

6.2.1 Disposal of Electronic Waste

As with most electronic products, this equipment must be disposed of in an environmentally friendly way, and in accordance with existing regulations for electronic waste.

Please contact your FLIR Systems representative for more details.

7. Specifications

7.1 General specifications

Display counts:	0~6000
Measuring rate:	3 times per second
Over-range indication:	OL or -OL.
Auto power off:	Programmable: OFF, 1, 2, 5, or 10 minutes
Low battery indicator:	☐ and 'LO BATT' is displayed.
Power requirement:	4 × 1.5 V AAA alkaline batteries.
Battery life:	Clamp mode Approx. 10 hours; IGMTM Mode 3 hours (with alkaline batteries and work light off)
Calibration:	1-year calibration cycle.
Operating temperature:	14 to 50°F (-10 to 10°C) (non-condensing) 50 to 86°F (10 to 30°C) (≤ 80% RH) 86 to 104°F (30 to 40°C) (≤ 75% RH) 104 to 122°F (40 to 50°C) (≤ 45%RH)
Storage temperature:	4 to 140°F (-20 to 60°C)
Relative Humidity:	0~80% RH (batteries not installed)
Temperature coefficient:	0.2 × (specified accuracy)/°C, <64.4°F (18°C), >82.4°F (28°C)
Operating altitude:	6562' (2000m)
Jaw opening:	1.38in. (35mm)
Pollution degree:	2
Dimensions:	(D × W × L): 1.7 × 3.5 × 9.5 in. (43 × 89 × 241 mm)
Weight:	15.0 oz. (426g) including batteries
Drop test:	6.6 ft. (2 meters)
Agency Approvals:	UL, CE, RCM, and KC (MSIP-REI-FS5-CM174)

Over-voltage category: EN 61010-1 CAT IV-600 V, CAT III-1000 V, EN 61010-2-032

CAT	Application field
III	Distribution circuits, machinery, main switching devices close to switchgears, industrial installations and high current close to distribution circuits
IV	Installation sources, utility transformers, all outside conductors, counters, protective devices on primary sides and electricity meters

7.2 IR Thermal Imaging Specifications

Detector type	FLIR Lepton™; Micro-bolometer Focal Plane Array (FPA)
Thermal Sensitivity	150mK
IR Imaging resolution	60 x 80 pixels
IR Imaging field of view	50.0 o x 38.6 o (vertical x horizontal)
IR Imaging spectral response	8 to 14µm
IR Image Capture Frequency	9Hz
IR Image Color Palettes	Programmable: Iron, Rainbow, and Gray scale
Shutter	Integrated, automatic shutter
Laser Pointer	Class I (red)
IR Temperature Measurement range	14°F ~ +302°F (-10°C ~ +150°C)
Over- and under- range indication	OL
Temperature reading stabilization	Dashes are displayed for approximately 30 seconds as temperature reading stabilizes
IR Temperature Resolution	0.1°F (0.1°C)
IR Temperature Accuracy	5.4°F (±3°C) or ± 3% of reading; whichever is greater (after 2-minute warm-up period)
Distance to Spot (D:S) ratio	30:1
Temperature Scanning	Continuous
Emissivity	4 presets plus a custom setting (0.10 to 0.99)
Targeting	Displayed Cross hairs pinpoint center of measurement spot

7.3 Electrical specifications

Accuracy is \pm (% reading + number of digits (dgt)) at 73.4 °F \pm 9 °F (23°C \pm 5 °C), <80% RH.

Table 7.1 Voltage (TRMS)

Function	Range	Accuracy (of reading)
DCV	60.00V	\pm (1.0% + 5 dgt)
	600.0V	
	1000 V	
ACV	60.00 V	\pm (1.0% + 5 dgt) 45~400 Hz
	600.0 V	
	1000 V	
ACV VFD	60.00 V	\pm (1% + 5 dgt) 45~65 Hz \pm (5% + 5 dgt) 65~400 Hz
	600.0 V	
	1000 V	
Lo Z (Low Impedance)	Range, resolution, and accuracy specifications for Low Impedance (Lo Z) measurements are the same as DCV, ACV, and VFD specifications shown above	

Notes:

LCD Displays '0' counts when the AC reading is <10 counts

Overload protection: 1000V (rms)

Input impedance: 10 M Ω //, <100 pF

Lo Z input impedance: 2.5k Ω

AC conversion type: AC coupled, true RMS responding, calibrated to the RMS value of a sine wave input. Accuracies are given for sine waves at full scale and non-sine waves below half scale.

If the meter measures a 4000-count signal and the Crest Factor of the signal is more than 3.0, the reading may not meet specified tolerances. For non-sine waves (50/60 Hz), add the following Crest Factor corrections:

For non-sine waves (50/60 Hz), add the following crest factor corrections:

For a crest factor of 1.0–2.0, add 3.0% to the accuracy.

For a crest factor of 2.0–2.5, add 5.0% to the accuracy.

For a crest factor of 2.5–3.0, add 7.0% to the accuracy.

Table 7.2 Current (TRMS)

Function	Range	Accuracy
DCA	60.00 A	$\pm(2\% + 5 \text{ dgt})$
	600.0 A	
ACA	60.00 A	$\pm (2\% + 5\text{dgt})$ 45 ~ 400Hz
	600.0 A	
ACA VFD	60.00 A	$\pm (2\% + 5 \text{ dgt})$ 45~65Hz
	600.0 A	$\pm (6\% + 5 \text{ dgt})$ 65~400Hz

Notes:

Overload protection: 600A (rms)

Position Error: $\pm 1\%$ of reading.

AC Conversion Type and additional accuracy is same as AC Voltage.

DCA affected by the temperature and residual magnetism; use DCA Zero function to compensate.

If the meter measures a 4000-count signal and the Crest Factor of the signal is more than 3.0, the reading may not meet specified tolerances. For non-sine waves (50/60 Hz), add the following Crest Factor corrections:

For non-sine waves (50/60 Hz), add the following crest factor corrections:

For a crest factor of 1.0–2.0, add 3.0% to the accuracy.

For a crest factor of 2.0–2.5, add 5.0% to the accuracy.

For a crest factor of 2.5–3.0, add 7.0% to the accuracy.

Table 7.3 Frequency (ACA and ACV)

Function	Range	Accuracy
Frequency	10.0~600.0 Hz	$\pm (0.1\% + 2 \text{ dgt})$
	6.000 kHz	
	60.00 kHz	

Notes:

Overload protection: 1000V (rms) and 600 A (rms)

Trigger Sensitivity:

>5V (rms) for ACV 10 Hz ~ 10 kHz

>15V (rms) for ACV 10 kHz ~ 60 kHz

>4A (rms) for ACA 10 Hz ~ 1 kHz

>8A (rms) for ACA 1 kHz ~ 10 kHz

Reading will be 0.0 for signals below 10.0 Hz

Table 7.4 Inrush current

Function	Range	Accuracy
ACA Inrush	60.00 A	$\pm(3\% + 0.3 \text{ A})$
	600.0 A	$\pm(3\% + 5 \text{ dgt})$

Inrush current detection threshold: 0.5A for 60A range and 5.0A for 600.0A range

Overload protection: 1000 V (rms), 600 A (rms).

Integration time is 100 ms.

Table 7.5 Resistance and continuity and diode

Function	Range	Accuracy
Resistance	600.0 Ω	$\pm(1.0\% + 5 \text{ dgt})$
	6.000 K Ω	
Continuity	600.0 Ω	$\pm(1.0\% + 5 \text{ dgt})$
Diode	1.5V	$\pm(1.5\% + 5 \text{ dgt})$

Overload protection: 1000 V (rms).

Maximum test current: Approx. 0.1 mA.

Maximum open circuit voltage for Ω : Approx. 1.8 V.

Maximum open circuit voltage for diode: Approx. 1.8 V.

Continuity threshold:

< 30 Ω beeper on.

> 150 Ω beeper off.

Continuity indicator: 2.7 kHz tone buzzer.

Continuity response time: <100 ms.

Table 7.6 Capacitance

Function	Range	Accuracy
Capacitance	1 μF to 1000 μF	$\pm(1.0\% + 4 \text{ dgt})$

Overload protection: 1000 V (rms).

Table 7.7 Flex Clamp Adaptor Function

Function	Range	Accuracy
Flex (ACA)	30.00 A	$\pm(1\% + 5 \text{ dgt})$ 45 ~ 400Hz
	300.0 A	
	3000 A	

LCD displays '0' counts when the reading is < 10 counts

Additional accuracy for the Flex function is listed in the FLIR clamp adaptor User Manuals (Models TA72_TA74).

Table 7.8 Flex Clamp Adaptor Function (Frequency)

Function	Range	Accuracy
Frequency (Flex)	600.0 Hz	$\pm(0.1\% + 2 \text{ dgt})$
	6.000 kHz	
	10.00 kHz	

Sensitivity: >4A (rms) for ACA 10Hz ~ 10kHz.

8. Technical Support

Main Website	http://www.flir.com/test
Technical Support Website	http://support.flir.com
Technical support Email	TMSupport@flir.com
Service/Repair Support Email	Repair@flir.com
Support Telephone number	+1 855-499-3662 option 3 (toll-free)

9. Warranty

9.1 FLIR Test & Measurement Imaging Product 10 year/10 year Limited Warranty

Congratulations! You (the “Purchaser”) are now the owner of a world-class FLIR Imaging Test and Measurement product. A qualifying FLIR Imaging Test and Measurement product (the “Product”) purchased either directly from FLIR Commercial Systems Inc. and affiliates (FLIR) or from an authorized FLIR distributor that Purchaser registers on-line with FLIR is eligible for coverage under FLIR’s industry-leading 10-10 Limited Warranty, subject to the terms and conditions in this document. This warranty only applies to purchases of Qualifying Products (see below) purchased after September 2015 and only to the original Purchaser of the Product.

PLEASE READ THIS DOCUMENT CAREFULLY; IT CONTAINS IMPORTANT INFORMATION ABOUT THE PRODUCTS THAT QUALIFY FOR COVERAGE UNDER THE 10-10 LIMITED WARRANTY, PURCHASER’S OBLIGATIONS, HOW TO ACTIVATE THE WARRANTY, WARRANTY COVERAGE, AND OTHER IMPORTANT TERMS, CONDITIONS, EXCLUSIONS AND DISCLAIMERS.

1. **PRODUCT REGISTRATION.** To qualify for FLIR’s 10-10 Limited Warranty, the Purchaser must fully register the Product directly with FLIR on-line at www.flir.com WITHIN Sixty (60) DAYS of the date the Product was purchased by the first retail customer (the “Purchase Date”). PRODUCTS THAT ARE NOT REGISTERED ON-LINE WITHIN Sixty (60) DAYS OF THE PURCHASE DATE OR PRODUCTS WHICH DO NOT QUALIFY FOR THE 10-10 WARRANTY WILL HAVE A LIMITED ONE YEAR WARRANTY FROM THE DATE OF PURCHASE.

2. **QUALIFYING PRODUCTS.** Upon registration, a list of thermal Imaging Test and Measurement Products that qualify for coverage under FLIR’s 10-10 Warranty can be found at www.flir.com/testwarranty

3. **WARRANTY PERIODS.** The 10-10 Limited Warranty has two separate periods of warranty coverage (the “Warranty Period”), depending on the Imaging Test and Measurement Product part:

Product components are warranted for a period of ten (10) years from the Purchase Date;

Thermal imaging sensor is warranted for a period of ten (10) years from the Purchase Date.

Any Product that is repaired or replaced under warranty is covered under this 10-10 Limited Warranty for one hundred eighty days (180) days from the date of return shipment by FLIR or for the remaining duration of the applicable Warranty Period, whichever is longer.

4. **LIMITED WARRANTY.** In accordance with the terms and conditions of this 10-10 Limited Warranty, and except as excluded or disclaimed in this document, FLIR warrants, from the Purchase Date, that all fully registered Products will conform to FLIR’s published Product specifications and be free from defects in materials and workmanship during the applicable Warranty Period. PURCHASER’S SOLE AND EXCLUSIVE REMEDY UNDER THIS WARRANTY, AT FLIR’S SOLE DISCRETION, IS THE REPAIR OR REPLACEMENT OF DEFECTIVE PRODUCTS IN A MANNER, AND BY A SERVICE CENTER, AUTHORIZED BY FLIR. IF THIS REMEDY IS ADJUDICATED TO BE INSUFFICIENT, FLIR SHALL REFUND PURCHASER’S PAID PURCHASE PRICE AND HAVE NO OTHER OBLIGATION OR LIABILITY TO BUYER WHATSOEVER.

5. **WARRANTY EXCLUSIONS AND DISCLAIMERS.** FLIR MAKES NO OTHER WARRANTY OF ANY KIND WITH RESPECT TO THE PRODUCTS. ALL OTHER WARRANTIES, EXPRESS OR IMPLIED, INCLUDING BUT NOT LIMITED TO IMPLIED WARRANTIES OF MERCHANTABILITY, FITNESS FOR A PARTICULAR PURPOSE (EVEN IF PURCHASER HAS NOTIFIED FLIR OF ITS INTENDED USE FOR THE PRODUCTS), AND NON-INFRINGEMENT ARE EXPRESSLY EXCLUDED FROM THIS AGREEMENT.

THIS WARRANTY EXPRESSLY EXCLUDES ROUTINE PRODUCT MAINTENANCE, AND SOFTWARE UPDATES. FLIR FURTHER EXPRESSLY DISCLAIMS ANY WARRANTY COVERAGE WHERE THE ALLEGED NONCONFORMITY IS DUE TO NORMAL WEAR AND TEAR OTHER THAN SENSORS, ALTERATION, MODIFICATION, REPAIR, ATTEMPTED REPAIR, IMPROPER USE, IMPROPER MAINTENANCE, NEGLIGENCE, ABUSE, IMPROPER STORAGE, FAILURE TO FOLLOW ANY PRODUCT INSTRUCTIONS, DAMAGE (WHETHER CAUSED BY ACCIDENT OR OTHERWISE), OR ANY OTHER IMPROPER CARE OR HANDLING OF THE PRODUCTS CAUSED BY ANYONE OTHER THAN FLIR OR FLIR’S EXPRESSLY AUTHORIZED DESIGNEE.

THIS DOCUMENT CONTAINS THE ENTIRE WARRANTY AGREEMENT BETWEEN PURCHASER AND FLIR AND SUPERSEDES ALL PRIOR WARRANTY NEGOTIATIONS, AGREEMENTS, PROMISES AND UNDERSTANDINGS BETWEEN PURCHASER AND FLIR. THIS WARRANTY MAY NOT BE ALTERED WITHOUT THE EXPRESS WRITTEN CONSENT OF FLIR.

6. **WARRANTY RETURN, REPAIR AND REPLACEMENT.** To be eligible for warranty repair or replacement, Purchaser must notify FLIR within thirty (30) days of discovering of any apparent defect in materials or workmanship. Before Purchaser may return a Product for warranty service or repair, Purchaser must first obtain a returned material authorization (RMA) number from FLIR. To obtain the RMA number Owner must provide an original proof of purchase. For additional information, to notify FLIR of an apparent defect in materials or workmanship, or to request an RMA number, visit www.flir.com. Purchaser is solely responsible for complying with all RMA instructions provided by FLIR including but not limited to adequately packaging the Product for shipment to FLIR and for all packaging and shipping costs. FLIR will pay for returning to Purchaser any Product that FLIR repairs or replaces under warranty.

FLIR reserves the right to determine, in its sole discretion, whether a returned Product is covered under warranty. If FLIR determines that any returned Product is not covered under warranty or is otherwise excluded from warranty coverage, FLIR may charge Purchaser a reasonable handling fee and return the Product to Purchaser, at Purchaser’s expense, or offer Purchaser the option of handling the Product as a non-warranty return. FLIR shall not be responsible for any data, images or other information that may be stored on the returned Product which was not included in the Product at the time of purchase. It is Purchaser’s responsibility to save any and all data prior to returning the Product for warranty service.

7. **NON-WARRANTY RETURN.** Purchase may request that FLIR evaluate and service or repair a Product not covered under warranty, which FLIR may agree to do in its sole discretion. Before Purchaser returns a Product for non-warranty evaluation and repair, Purchaser must contact FLIR by visiting www.flir.com to request an evaluation and obtain an RMA. Purchaser is solely responsible for complying with all RMA instructions provided by FLIR including but not limited to adequately packaging the Product for shipment to FLIR and for all packaging and shipping costs. Upon receipt of an authorized non-warranty return, FLIR will evaluate the Product and contact Purchaser regarding the feasibility of and the costs and fees associated with Purchaser’s request. Purchaser shall be responsible for the reasonable cost of FLIR’s evaluation, for the cost of any repairs or services authorized by Purchaser, and for the cost of repackaging and returning the Product to Purchaser.

Any non-warranty repair of a Product is warranted for one hundred eighty days (180) days from the date of return shipment by FLIR to be free from defects in materials and workmanship only, subject to all of the limitations, exclusions and disclaimers in this document.



Corporate Headquarters
FLIR Systems, Inc.
2770 SW Parkway Avenue
Wilsonville, OR 97070
USA
Telephone: +1 503-498-3547

Customer Support
Technical Support Website <http://support.flir.com>
Technical Support Email TMSupport@flir.com
Service and Repair Email Repair@flir.com
Customer Support Telephone +1 855-499-3662 option 3 (toll free)

Publication Identification No.: CM174-en-US
Release Version: AC
Release Date: 2017 August
Language: en-US