

Quick Start Guide

TDAIO250P200_0v1

Evaluation Platform
250W PFC + LLC power supply

transphorm

Highest Performance, Highest Reliability GaN

9/2017

Equipment Needed

- ➔ The TDAI0250P200_0v1 board
- ➔ Cooling fan
 - >30 CFM air flow
- ➔ AC power source
 - $90V_{AC}$ to $265V_{AC}$
 - >300W capability
- ➔ Resistive load
 - <250W @ $12V_{DC}$ ($>1.67\Omega$)
- ➔ Discharging resistor
 - 4 Ω 150W ARCOL resistor

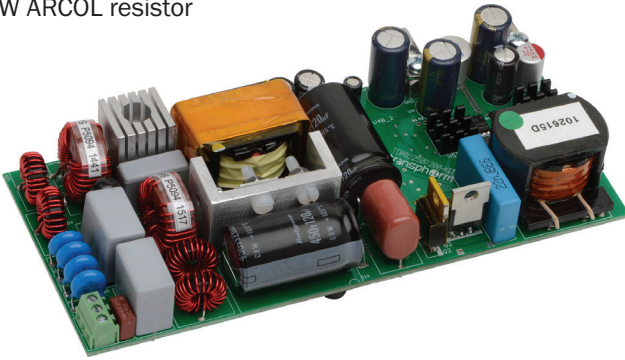

Cautions and Warnings



This evaluation board is intended to demonstrate GaN FET technology and is for demonstration purposes only and no guarantees are made for standards compliance.

There are areas of this evaluation board that have exposed access to hazardous high voltage levels. Exercise caution to avoid contact with those voltages. Also note that the evaluation board may retain high voltage temporarily after input power has been removed. Exercise caution when handling.

When testing converters on an evaluation board, ensure adequate cooling. Apply cooling air with a fan blowing across the converter or across a heatsink attached to the converter. Monitor the converter temperature to ensure it does not exceed the maximum rated per the datasheet specification.

Simplified Schematic

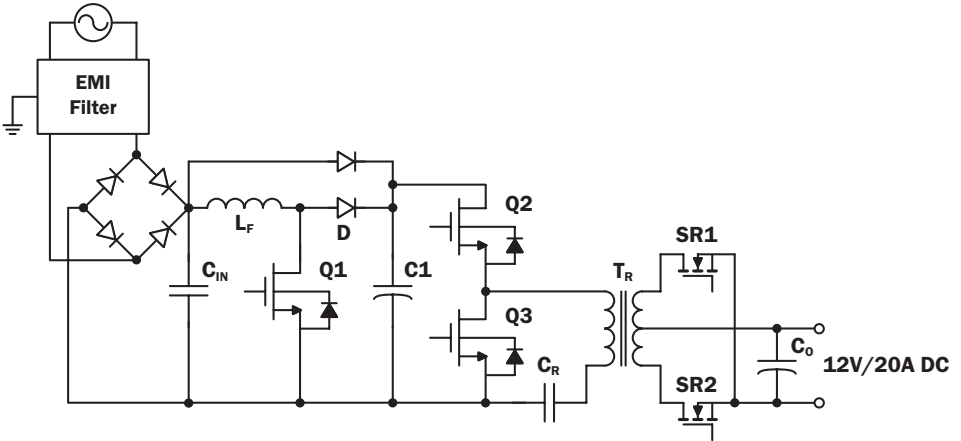

Step 1: Connect the Board

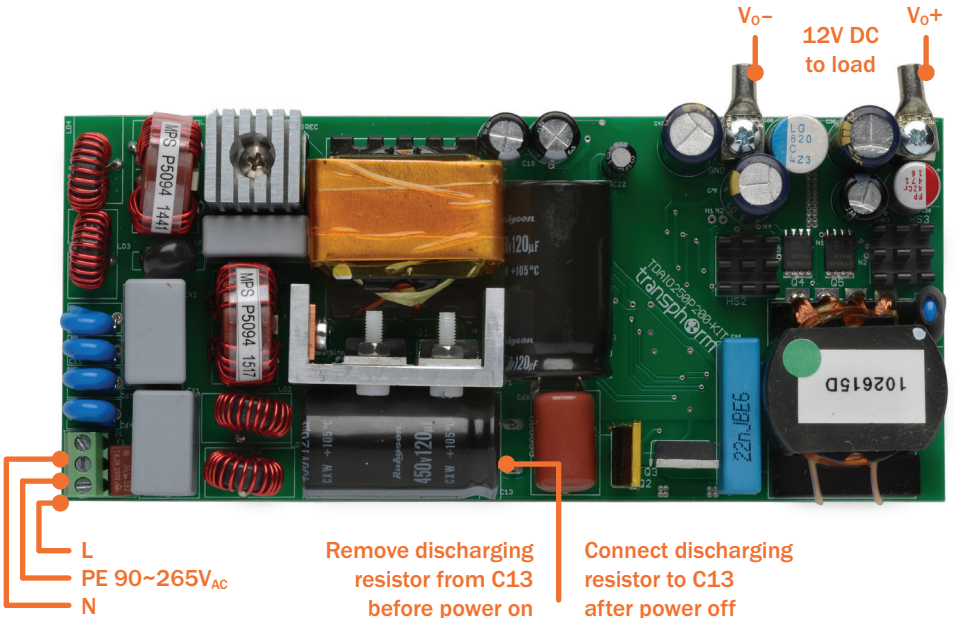

Step 2: Connect the Probes

- ➔ Connect the voltage probe's measuring lead to the drain pin
- ➔ Connect the voltage probe's ground lead to the source pin

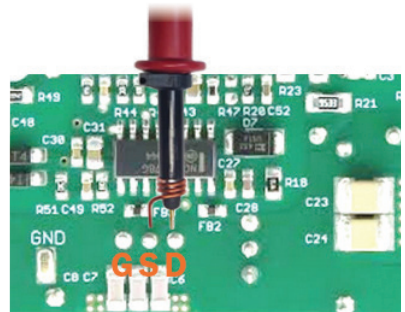
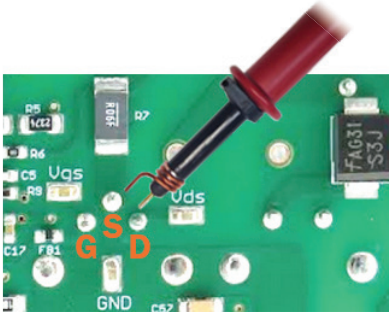
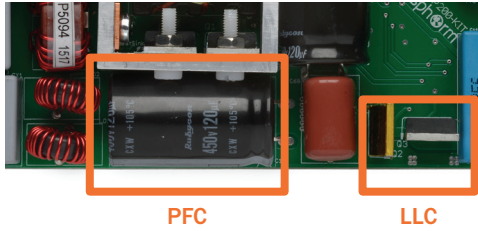

Note:

To minimize additional inductance during measurement, the tip and the ground of the probe should be directly attached to the sensing points to minimize the sensing loop; while the typical long ground lead should be avoided since it will form a sensing loop and could pick up the noise. Differential probes are not recommended for the GaN signal measurement.

Step 3: Power-up the Board

- ➔ Place the cooling fan facing the GaN FETs' heat sinks of the PFC and LLC and turn on the cooling fan if the output power is higher than 200W
- ➔ Disable the discharging resistor (C13)
- ➔ Enable the resistive load and make sure output power is set to below 250W @ 12V_{DC}
- ➔ Enable the AC input; the voltage should be set between 90V_{AC} and 265V_{AC}

Step 4: Power-down the Board

- ➔ Turn off AC power supply (J1)
- ➔ Connect discharging resistor to C13 and wait 10 seconds to ensure voltage decreases to a safe level
- ➔ Remove resistive load

Typical Performance Curves

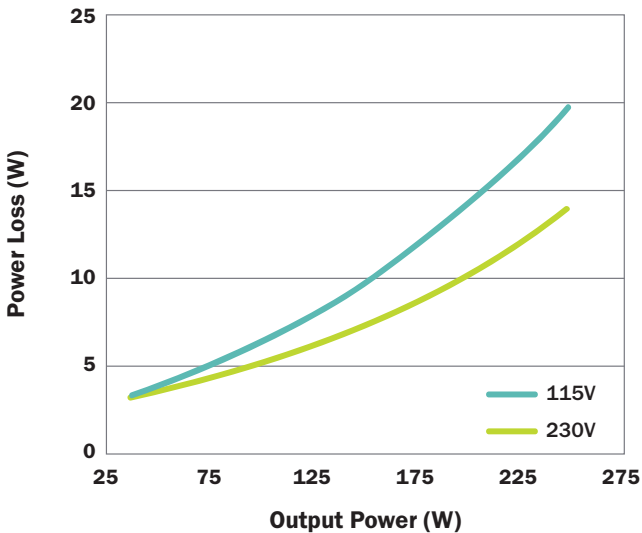
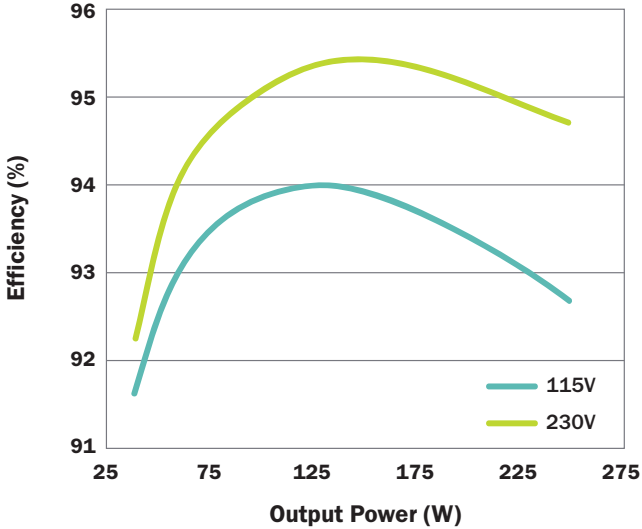



transphorm

+1 805 456 1300
transphormusa.com

TDAI0250P200_0v1
For evaluation purposes only

Design files and more at
transphormusa.com/aio25kit