

HWS SERIES

Single Output 300W-1800W

Contents

- HWS/HD
- HWS/ME
- Block Diagram, Sequence Time Chart
- HWS, HWS/HD, HWS/ME Instruction Manual
- HWS-P

- a_HWS_13 Page
- a_HWS_25 Page
- a_HWS_35 Page
- a_HWS_39 Page
- a_HWS_79 Page

HWS

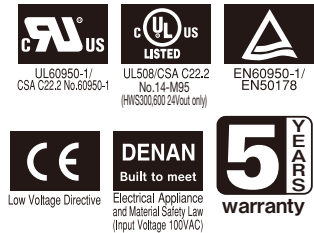

Features

- Environmentally-friendly:
High-efficiency technology reduces power loss by heat generation. Fan stopping in power-off by external control reduces acoustic noise and saves energy.
- Easy to use: All models in the same height of 82mm. Mountable in 2U-height racks without dead space.
- Safety and reliability: "Safety terminal" covering current flowing part secures safety for users. "No screw-dropping" design prevents from losing screws during maintenance operation.

Model naming method

HWS 300 – 5 / □ □

Series name Output power

Blank: With cover, forced air cooling with built-in fan
 PV: Output voltage adjustable by external voltage 12Vout+ models for HWS300, 600 only.
 (Supported by standard models for HWS1000 and above.)
 Nominal output voltage
 ex. 3: 3.3V, 5: 5V, 48: 48V

Applications

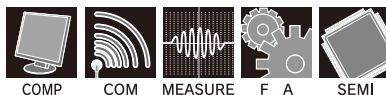

Conformity to RoHS Directive

This means that, in conformity with EU Directive 2002/95/EC, lead, cadmium, mercury, hexavalent chromium, and specific bromine-based flame retardants, PBB and PBDE, have not been used, except for exempted applications.

Product Line up

Output Voltage	300W		600W		1000W		1500W		1800W	
	Output Current (Peak)	Model	Output Current (Peak)	Model	Output Current (Peak)	Model	Output Current (Peak)	Model	Output Current (Peak)	Model
3.3V	60A	HWS300-3	120A	HWS600-3	200A	HWS1000-3	300A/300A	HWS1500-3	300A	HWS1800T-3
5V	60A	HWS300-5	120A	HWS600-5	200A	HWS1000-5	300A/300A	HWS1500-5	300A	HWS1800T-5
6V	—	—	—	—	167A	HWS1000-6	250A/250A (300A)	HWS1500-6	250A (300A)	HWS1800T-6
7.5V	—	—	—	—	134A (160A)	HWS1000-7	200A/200A (240A)	HWS1500-7	200A (240A)	HWS1800T-7
12V	27A	HWS300-12	53A	HWS600-12	88A (100A)	HWS1000-12	125A/125A	HWS1500-12	125A (150A)	HWS1800T-12
15V	22A	HWS300-15	43A	HWS600-15	70A (80A)	HWS1000-15	100A/100A	HWS1500-15	100A (120A)	HWS1800T-15
24V	14A (16.5A)	HWS300-24	27A (31A)	HWS600-24	46A (58.5A)	HWS1000-24	65A/70A (105A)	HWS1500-24	75A (105A)	HWS1800T-24
36V	—	—	—	—	30.7A (39A)	HWS1000-36	42A/46.5A (70A)	HWS1500-36	50A (70A)	HWS1800T-36
48V	7A	HWS300-48	13A	HWS600-48	23A (29.2A)	HWS1000-48	32A/32A	HWS1500-48	37.5A (52.5A)	HWS1800T-48
60V	—	—	—	—	18.4A (23.4A)	HWS1000-60	25.6A/28A (42A)	HWS1500-60	30A (42A)	HWS1800T-60

(*) (100Vin / 200Vin)

HWS300 Specifications

(Read instruction manual carefully, before using the power supply unit.)

ITEMS/UNITS		MODEL	HWS300-3	HWS300-5	HWS300-12	HWS300-15	HWS300-24	HWS300-48
Input	Voltage Range (*2)	V	AC85 - 265 or DC120 - 330					
	Frequency (*2)	Hz	47 - 63					
	Power Factor (100/200VAC)(typ) (*1)		0.99 / 0.95					
	Efficiency (100/200VAC)(typ) (*1)		74 / 77	79 / 82	80 / 83		82 / 85	
	Current (100/200VAC)(typ) (*1)	A	2.7 / 1.4	3.8 / 1.9	4.1 / 2.1			
	Inrush Current (100/200VAC)(typ) (*3)	A	20 / 40					
Output	Leakage Current (*10)	mA	Less than 0.75. (0.2 (typ) at 100VAC / 0.44 (typ) at 230VAC)					
	Nominal Voltage	VDC	3.3	5	12	15	24	48
	Maximum Current (*13)	A	60		27	22	14 (16.5)	7
	Maximum Power	W	198	300	324	330	336	
	Maximum Line Regulation (*5)	mV	20		48	60	96	192
	Maximum Load Regulation (*6)	mV	30		72	90	144	288
	Temperature Coefficient		Less than 0.02% / °C					
	Maximum Ripple & Noise (0≤Ta≤70°C) (*4)	mVp-p	120		150		350	
	Maximum Ripple & Noise (-10≤Ta<0°C) (*4)	mVp-p	180		200		400	
	Hold-up Time (typ) (*9)	ms	20					
Function	Voltage Adjustable Range	VDC	2.64 - 3.96	4.0 - 6.0	9.6 - 14.4	12.0 - 18.0	19.2 - 28.8	38.4 - 52.8
	Over Current Protection (*7)	A	>63		> 28.4	>23.1	>16.7	>7.4
	Over Voltage Protection (*8)	V	4.13 - 4.95	6.25 - 7.25	15.0 - 17.4	18.8 - 21.8	30.0 - 34.8	55.2 - 64.8
	Remote Sensing		Possible					
	Remote ON/OFF Control		Possible					
	Parallel Operation		Possible					
	Series Operation		Possible					
	Monitoring Signal		PF (Open collector output)					
	Line DIP		Designed to meet SEMI-F47 (200VAC Line only)					
	Environment	Operating Temperature (*11)		-10 to +70 (-10 to +50: 100%, +70: 50%)				
Storage Temperature			-30 to +85					
Operating Humidity		RH	10 - 90 (No dewdrop)					
Storage Humidity		RH	10 - 95 (No dewdrop)					
Vibration			At no operating, 10 - 55Hz (sweep for 1min) 19.6m/s ² constant, X, Y, Z 1hour each.					
Shock (In package)			Less than 196.1m/s ²					
Cooling			Forced air by blower fan					
Isolation	Withstand Voltage		Input - FG : 2.5kVAC (20mA), Input - Output : 3kVAC (20mA) Output - FG: 500VAC (100mA), Output-CNT: 100VAC(100mA) for 1min					
	Isolation Resistance		More than 100MΩ Output - FG : 500VDC More than 10MΩ Output -CNT : 100VDC at 25°C and 70%RH					
Standards	Safety Standards (*12)		Approved by UL60950-1, UL508 (24V model only), CSA C22.2 No.60950-1, CSA C22.2 No.14-M95 (24V model only), EN60950-1, EN50178 Designed to meet DENAN					
	PFHC		Designed to meet IEC61000-3-2					
	EMI		Designed to meet EN55011/EN55022-B, FCC-B, VCCI-B					
Mechanical	Immunity		Designed to meet IEC61000-4-2(Level 2,3), -3(Level 3), -4(Level3), -5(Level 3,4), -6(Level 3), -8(Level 4), -11					
	Weight (typ)	g	1000					
	Size (W x H x D)	mm	61 x 82 x 165 (Refer to outline drawing)					

(*1) At 100/200VAC, Ta=25°C and maximum output power.

(*2) For cases where conformance to various safety specs (UL, CSA, EN) are required, to be described as 100-240VAC (50/60Hz).

(*3) Not applicable for the inrush current to noise filter for less than 0.2ms.

(*4) Measure with JEITA RC-9131A probe, bandwidth of scope :100MHz.

(*5) 85 - 265VAC, constant load.

(*6) No load-full load, constant input voltage.

(*7) 3.3, 5V model: Constant current limit and hiccup with automatic recovery.

12 - 48V model: Constant current limit with automatic recovery.

Avoid to operate at over load or short circuit condition for more than 30 seconds.

(*8) OVP circuit will shut the output down, manual reset (CNT reset or Re power on).

(*9) At 100/200VAC, nominal output voltage and maximum output current.

(*10) Measured by the each measuring method of UL, CSA, EN and DENAN (at 60Hz), Ta=25 .

(*11) Ratings - Derating at standard mounting. Refer to output derating curve.

- Load (%) is percent of maximum output power or maximum output current, whichever is greater.

(*12) As for DENAN, designed to meet at 100VAC.

(*13) (): Peak output current at 200VAC. Operating time at peak output is less than 10 sec, duty is less than 35%.

Recommended EMC Filter



RSEN-2006

Please refer to "TDK-Lambda EMC Filters" catalog.

Outline Drawing

[HWS300]

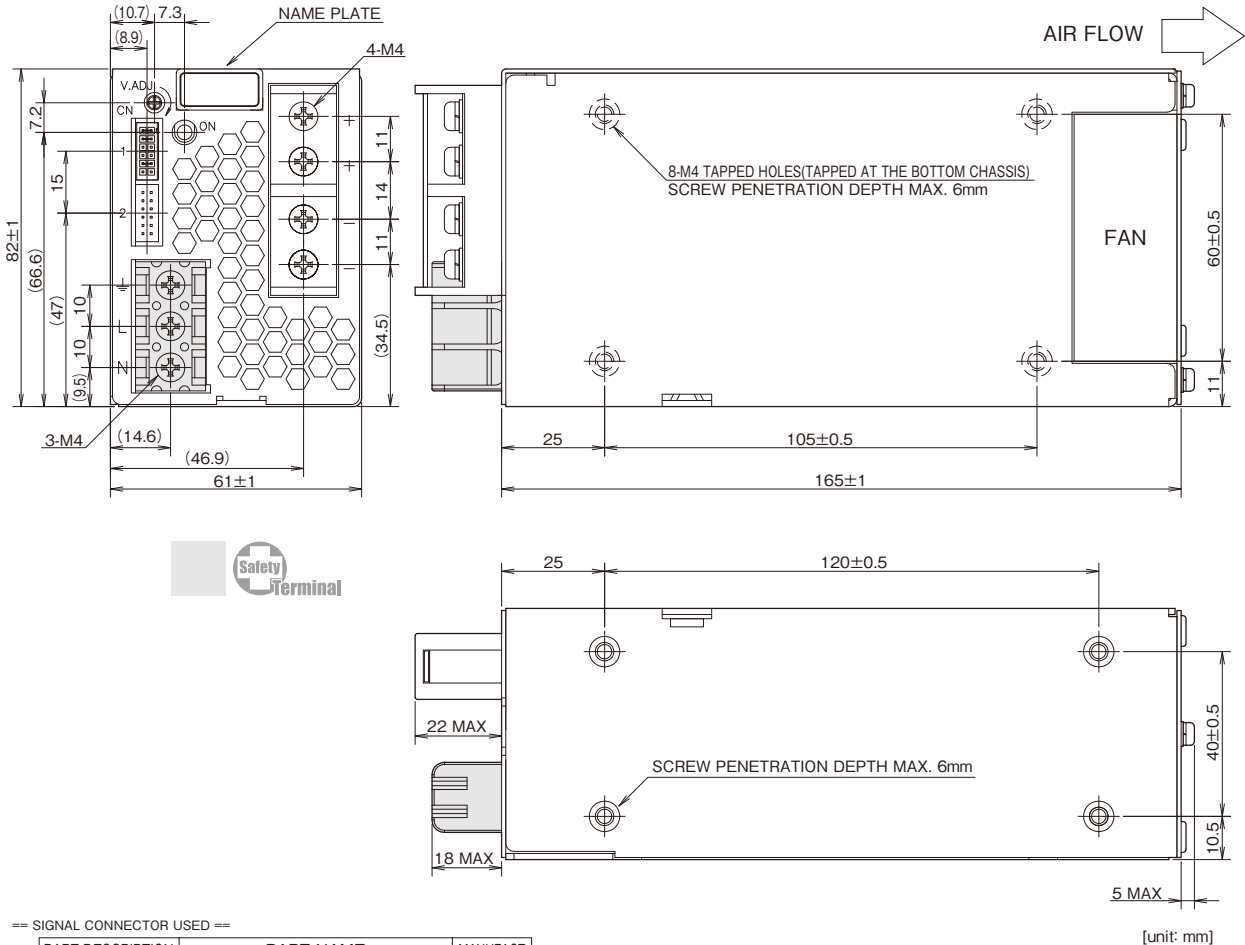

== SIGNAL CONNECTOR USED ==

PART DESCRIPTION	PART NAME	MANUFACT
PIN HEADER	S12B-PHDSS	JST

== MATCHING HOUSINGS , PINS & TOOL ==

PART DESCRIPTION	PART NAME	MANUFACT
SOCKET HOUSING	PHDR-12VS	JST
TERMINAL PINS	SPHD-002T-P0.5 (AWG28 - 24) SPHD-001T-P0.5 (AWG26 - 22)	JST
HAND CRIMPING TOOL	YRS-620 (SPHD-002T-P0.5) YC-610R (SPHD-001T-P0.5)	JST

== ACCESSORIES ==
 *COVER FOR BARRIER TERMINAL STRIP1
 (ATTACHED ON TERMINAL AT SHIPMENT)
 *SHORT PIECE1
 SHORTING +Vm→+S, -Vm→S, CNT→TOG
 (ATTACHED ON CN1 AT SHIPMENT)

[unit: mm]

Output Derating

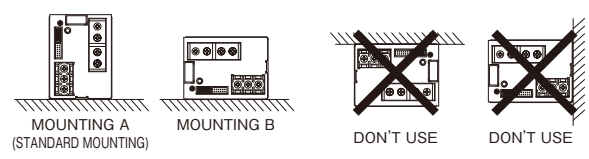
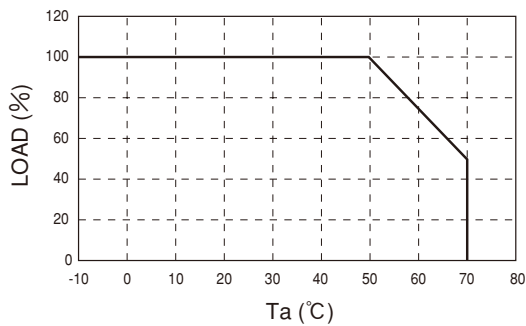

· All specifications are subject to change without notice.

HWS600 Specifications (Read instruction manual carefully, before using the power supply unit.)

ITEMS/UNITS		MODEL	HWS600-3	HWS600-5	HWS600-12	HWS600-15	HWS600-24	HWS600-48
Input	Voltage Range (*2)	V	AC85 - 265 or DC120 - 330					
	Frequency (*2)	Hz	47 - 63					
	Power Factor (100/200VAC)(typ) (*1)		0.99 / 0.95					
	Efficiency (100/200VAC)(typ) (*1)		75 / 78	80 / 83		81 / 84	82 / 85	83 / 86
	Current (100/200VAC)(typ) (*1)	A	5.4 / 2.6	7.5 / 3.6	8.1 / 3.9			
	Inrush Current (100/200VAC)(typ) (*3)	A	20 / 40					
Output	Leakage Current (*10)	mA	Less than 0.75. (0.2 (typ) at 100VAC / 0.44 (typ) at 230VAC)					
	Nominal Voltage	VDC	3.3	5	12	15	24	48
	Maximum Current (*13)	A	120		53	43	27(31)	13
	Maximum Power	W	396	600	636	645	648	624
	Maximum Line Regulation (*5)	mV	20		48	60	96	192
	Maximum Load Regulation (*6)	mV	30		72	90	144	288
	Temperature Coefficient		Less than 0.02% / °C					
	Maximum Ripple & Noise (0≤Ta≤70°C) (*4)	mVp-p	120		150		350	
	Maximum Ripple & Noise (-10≤Ta≤0°C) (*4)	mVp-p	180		200		400	
	Hold-up Time (typ) (*9)	ms	20ms					
	Function	Voltage Adjustable Range	VDC	2.64 - 3.96	4.0 - 6.0	9.6 - 14.4	12.0 - 18.0	19.2 - 28.8
Over Current Protection (*7)		A	>126		>55.7	>45.2	>31.4	>13.7
Over Voltage Protection (*8)		VDC	4.13 - 4.95	6.25 - 7.25	15.0 - 17.4	18.8 - 21.8	30.0 - 34.8	55.2 - 64.8
Remote Sensing			Possible					
Remote ON/OFF Control			Possible					
Parallel Operation			Possible					
Series Operation			Possible					
Monitoring Signal			PF (Open collector output)					
Line DIP			Designed to meet SEMI-F47 (200VAC Line only)					
Environment		Operating Temperature (*11)		-10 to +70 (-10 to +50: 100%, +70: 50%)				
	Storage Temperature		-30 to +85					
	Operating Humidity	RH	10 - 90 (No dewdrop)					
	Storage Humidity	RH	10 - 95 (No dewdrop)					
	Vibration		At no operating, 10 - 55Hz (sweep for 1min) 19.6m/s ² constant, X, Y, Z 1hour each.					
	Shock (In package)		Less than 196.1m/s ²					
Isolation	Cooling		Forced air by blower fan					
	Withstand Voltage		Input - FG : 2.5kVAC (20mA), Input - Output : 3kVAC (20mA) Output - FG : 500VAC (100mA), Output - CNT : 100VAC (100mA) for 1min					
	Isolation Resistance		More than 100MΩ Output - FG : 500VDC More than 10MΩ Output - CNT: 100VDC at 25°C and 70%RH					
Standards	Safety Standards (*12)		Approved by UL60950-1, UL508 (24V model only), CSA C22.2 No.60950-1, CSA C22.2 No.14-M95 (24V model only), EN60950-1, EN50178, Designed to meet DENAN					
	PFHC		Designed to meet IEC61000-3-2					
	EMI		Designed to meet EN55011/EN55022-B, FCC-B, VCCI-B					
	Immunity		Designed to meet IEC61000-4-2(Level 2,3), -3(Level 3), -4(Level 3), -5(Level 3,4), -6(Level 3), -8(Level 4), -11					
Mechanical	Weight (typ)	g	1600					
	Size (W x H x D)	mm	100 x 82 x 165 (Refer to outline drawing)					

● Recommended EMC Filter



RSEN-2016

Please refer to "TDK-Lambda EMC Filters" catalog.

Outline Drawing

[HWS600]

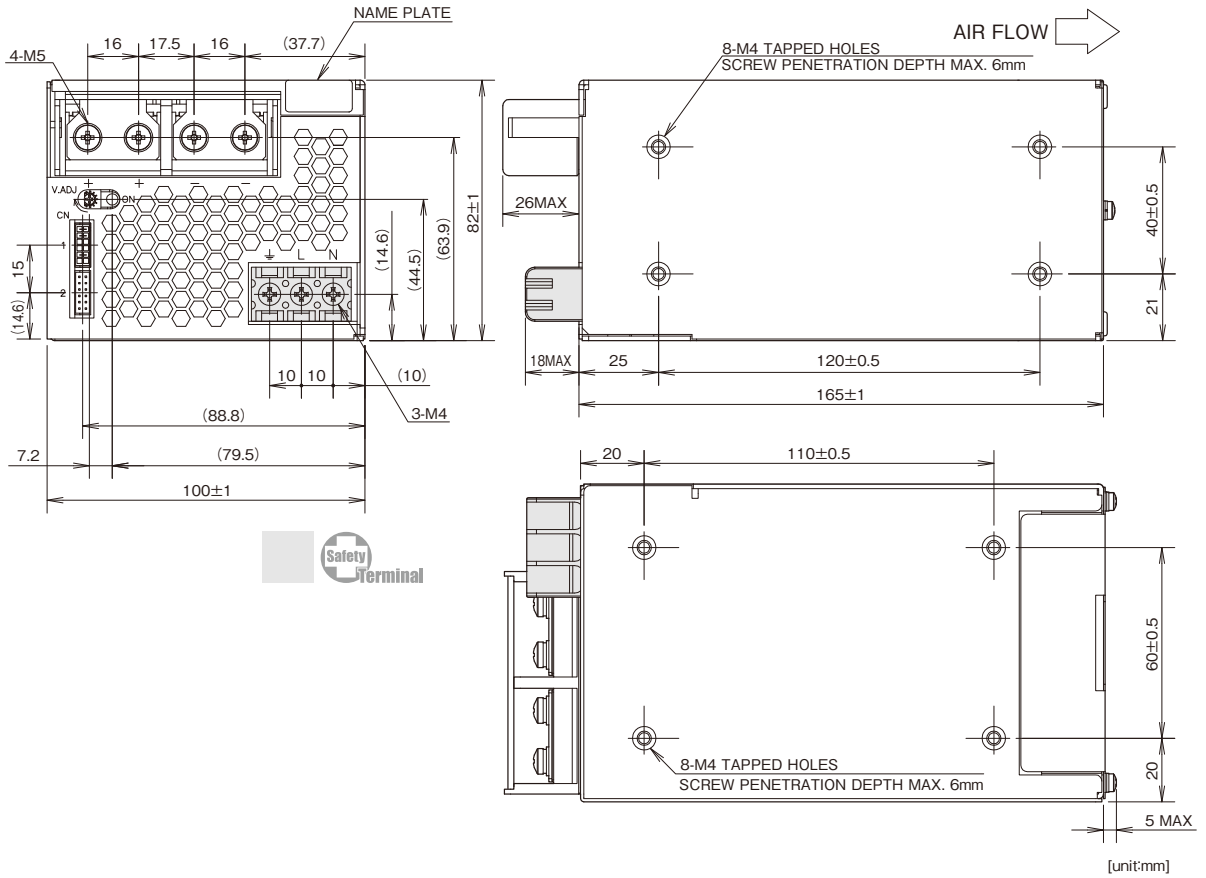

== SIGNAL CONNECTOR USED ==

PART DESCRIPTION	PART NAME	MANUFACT
PIN HEADER	S12B-PHDSS	JST

== MATCHING HOUSINGS, PINS & TOOL ==

PART DESCRIPTION	PART NAME	MANUFACT
SOCKET HOUSING	PHDR-12VS	JST
TERMINAL PINS	SPHD-002T-P0.5 (AWG28 - 24) SPHD-001T-P0.5 (AWG26 - 22)	JST
HAND CRIMPING TOOL	YRS-620 (SPHD-002T-P0.5) YC-610R (SPHD-001T-P0.5)	JST

== ACCESSORIES ==

- *COVER FOR BARRIER TERMINAL STRIP1 (ATTACHED ON TERMINAL AT SHIPMENT)
- *SHORT PIECE1 (SHORTING +Vm→+S, -Vm→-S, CNT→TOG (ATTACHED ON CN1 AT SHIPMENT))

Output Derating

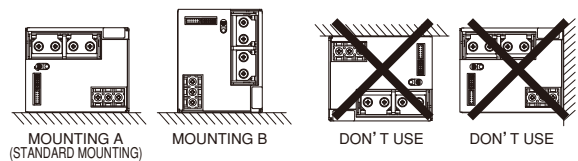
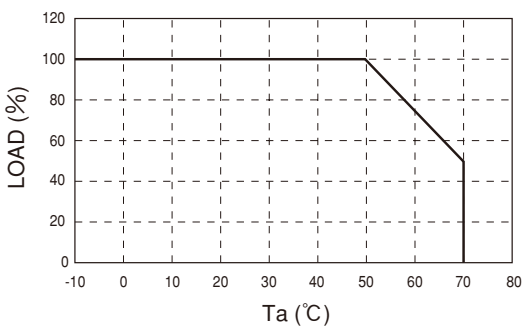

HWS1000 Specifications (Read instruction manual carefully, before using the power supply unit.)

HWS

HWS HD

HWS ME

HWS-P

Instruction Manual

ITEMS/UNITS		MODEL	HWS1000-3	HWS1000-5	HWS1000-6	HWS1000-7	HWS1000-12	HWS1000-15	HWS1000-24	HWS1000-36	HWS1000-48	HWS1000-60		
Input	Voltage Range (*2)	V	AC85 - 265 or DC120 - 330											
	Frequency (*2)	Hz	47 - 63											
	Power Factor (100/200VAC)(typ) (*1)		0.98 / 0.95											
	Efficiency (100/200VAC)(typ) (*1)	%	71 / 73	76 / 78	79 / 81	80 / 82	82 / 85	83 / 85	85 / 87	85 / 88	86 / 88	85 / 88		
	Current (100/200VAC)(typ) (*1)	A	9.6 / 5.0 13.5 / 7.0											
	Inrush Current (100/200VAC)(typ) (*3)	A	20 / 40											
	Leakage Current (100/240VAC) (*10)	mA	1.2 max											
Output	Nominal Voltage	VDC	3.3	5	6	7.5	12	15	24	36	48	60		
	Maximum Current	A	200		167	134	88	70	46	30.7	23	18.4		
	Maximum Peak Current (*13)	A	-		160	100	80	58.5	39	29.2	23.4			
	Maximum Power	W	660	1000	1002	1005	1056	1050	1104					
	Maximum Peak Power (*13)	W	-		1200	1404								
	Maximum Line Regulation (*5)	mV	20		36		48		60		96	144	192	240
	Maximum Load Regulation (*6)	mV	40		60		100		120		150		300	360
	Temperature Coefficient		Less than 0.02%/°C											
	Maximum	0 to +71°C	mVp-p		120		150				200		400	
	Ripple & Noise (*4)	-10 to 0°C	mVp-p		160		180				240	500	600	
	Hold-up Time (typ) (*9)	ms	20											
	Voltage Adjustable Range	VDC	2.64 - 3.96	4.0 - 6.0	4.8 - 7.2	6.0 - 9.0	9.6 - 14.4	12.0 - 18.0	19.2 - 28.8	28.8 - 43.2	38.4 - 52.8	48.0 - 66.0		
	Function	Over Current Protection (*7)	A	>210.0		>175.3	>168.0	>105.0	>84.0	>61.4	>40.9	>30.6	>24.5	
Over Voltage Protection (*8)		VDC	4.12 - 4.62	6.25 - 7.0	7.5 - 8.4	9.37 - 10.5	15.0 - 17.4	18.7 - 21.8	30.0 - 34.8	45.0 - 49.7	55.2 - 60.0	69.0 - 75.0		
Remote Sensing			Possible											
Remote ON/OFF Control			Possible											
Parallel Operation			Possible											
Series Operation			Possible											
Monitoring Signal			PF (Open collector output)											
Line DIP			Built to meet SEMI-F47 (200VAC line only)											
Environment		Operating Temperature (*11)	°C	-10 to +71, start up -20 to +71										
			-10 to +40°C	%										
	+50°C		83.9		100									
	+71°C		%											
	Storage Temperature	°C	-30 to +85											
	Operating Humidity	%RH	10 - 90 (No Condensing)											
	Storage Humidity	%RH	10 - 95 (No Condensing)											
Vibration		At no operating, 10 - 55Hz (sweep for 1min.) 19.6m/s ² constant, X, Y, Z 1hour each.												
Shock (In package)		Less than 196.1m/s ²												
Cooling		Forced air by blower fan												
Isolation	Withstand Voltage		Input - FG : 2kVAC (20mA), Input - Output : 3kVAC (20mA) Output-FG : 500VAC (300mA) (60V model 651VAC (390mA)), Output-CNT:100VAC (100mA) for 1min.											
	Isolation Resistance		More than 100MΩ Output - FG : 500VDC More than 10MΩ Output - CNT 100VDC at 25°C and 70%RH											
Standards	Safety Standards (*12)		Approved by UL60950-1, CSA C22.2 No60950-1, EN60950-1,EN50178. Built to meet DENAN.											
	PFHC		Built to meet IEC61000-3-2											
	EMI		Built to meet EN55011/EN55022-B, FCC-ClassB, VCCI-ClassB, CISPR-ClassB.											
Mechanical	Immunity		Built to meet IEC61000-4-2(Level 2,3), -3(Level 3), -4(Level 3), -5(Level 3,4), -6(Level 3), -8(Level 4), -11											
	Weight (max)	g	3200											
Size (W x H x D)	mm	126.5 x 82 x 240 (Refer to outline drawing)												

(*1) At Ta=25°C and maximum output power.

(*2) For cases where conformance to various safety specs (UL, CSA, EN) are required, input voltage range will be 100 - 240VAC (50/60Hz).

(*3) First in-rush current. Not applicable to the first 0.2ms in-rush current flowing into the power supply noise filter.

(*4) Measure with JEITA RC-9131A probe, bandwidth of scope :100MHz.
At 100uF electric capacitor and 0.47uF film capacitor on the test fixture board.)

(*5) 85 - 265VAC, constant load.

(*6) No load-full load, constant input voltage.

(*7) Constant current limit with automatic recovery. Over current condition for more than 5 seconds will cause the output to shutdown.
Output current exceeding maximum rated output current for more then 10 seconds continuously will result to output shutdown.

(*8) OVP circuit will shut down output, manual reset (power cycle) or ON/OFF CNT signal reset.

(*9) At 100/200VAC, nominal output voltage and maximum output current.

(*10) Measured by the each measuring method of UL, CSA, EN and DENAN (at 60Hz, Ta=25 .

(*11) Ratings - Derating at standard mounting.

- Load (%) is percent of maximum output power or maximum output current, whichever is greater.
- As for other mountings, refer to derating curve.

(*12) As for DENAN, built to meet at 100VAC.

(*13) Peak output current is less than 10 seconds, and duty 35% max.(200VAC Line only)

Recommended EMC Filter



RSEN-2020

Please refer to "TDK-Lambda EMC Filters" catalog.

Outline Drawing

[HWS1000]

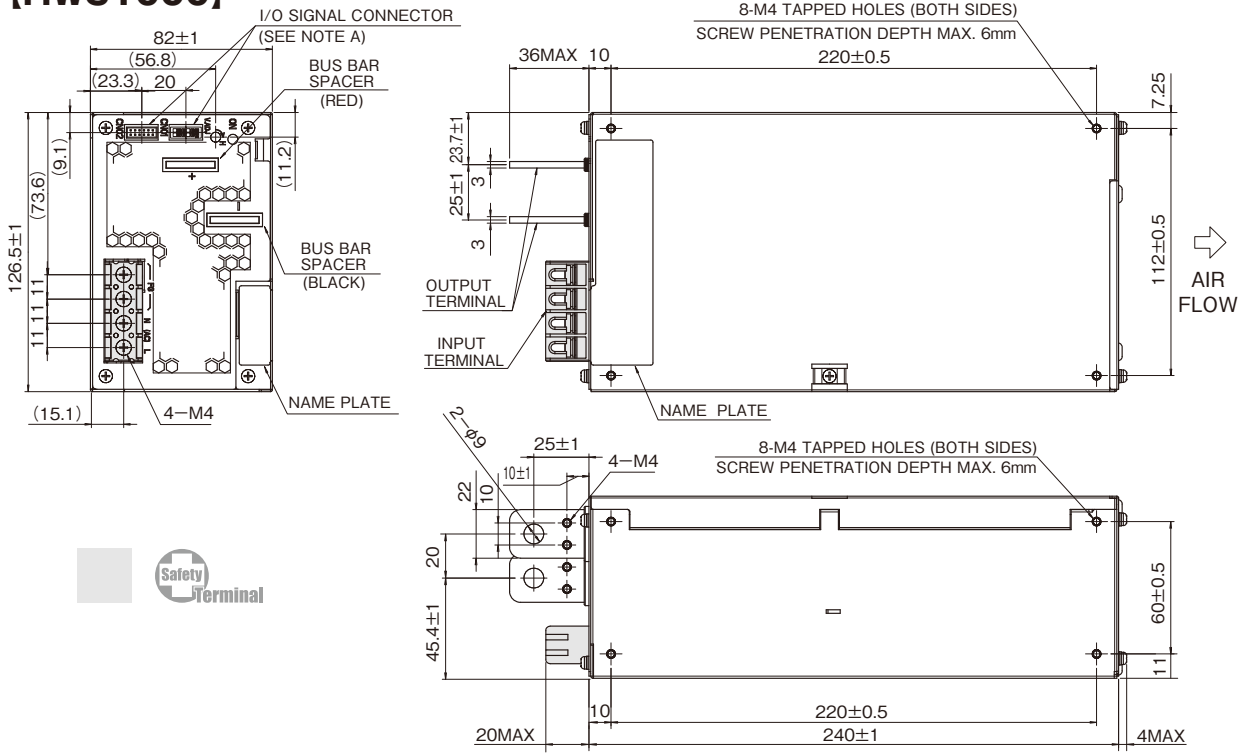

[unit: mm]
 [Chassis material:SPCC-SD]

NOTES

A : I/O SIGNAL CONNECTOR

- CONNECTOR : S12B-PHDSS (LF) (SN) (JST)
- MATCHING HOUSING : PHDR-12VS (JST)
- MATCHING CONTACT : SPHD-002T-P0.5 (AWG28 - 24) (JST) OR
 SPHD-001T-P0.5 (AWG26 - 22) (JST) OR
 BPHD-001T-P0.5 (AWG26 - 22) (JST)
- HAND CRIMPING TOOL : YRS-620 (SPHD-002T-P0.5) (JST)
 YC-610R (SPHD-001T-P0.5) (JST)
 YC-610R (BPHD-001T-P0.5) (JST)

ACCESSORIES

- * ATTACHED CONNECTOR SHORTING +S ~ +V, -S ~ -V, PV ~ REF & CNT ~ TOG ATTACHED ON CN02 AT SHIPMENT
- * A separate connector not included is required in order to utilize the power supply function.

Output Derating

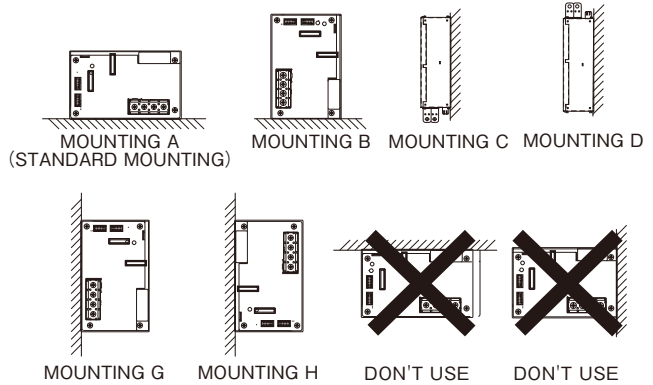
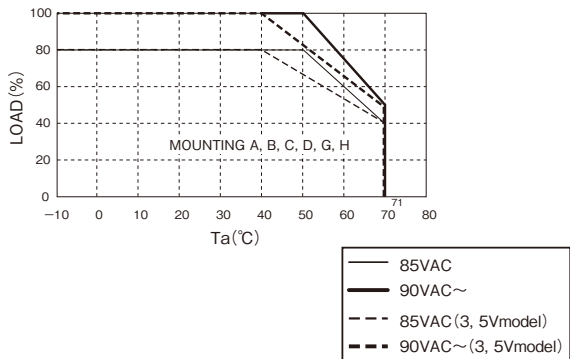

*It cannot be used even the product is flipped vertically.

HWS1500 Specifications (Read instruction manual carefully, before using the power supply unit.)

ITEMS/UNITS		MODEL	HWS1500-3	HWS1500-5	HWS1500-6	HWS1500-7	HWS1500-12	HWS1500-15	HWS1500-24	HWS1500-36	HWS1500-48	HWS1500-60	
Input	Voltage Range (*2)	V	AC85 - 265 or DC120 - 330										
	Frequency (*2)	Hz	47 - 63										
	Power Factor (100/230VAC)(typ) (*1)		0.98 / 0.94										
	Efficiency (100/200VAC)(typ) (*1)	%	72 / 75	77 / 81	79 / 82	81 / 83	82 / 85	83 / 87	84 / 88		86 / 90		
	Current (100/200VAC)(typ) (*1)	A	15.0 / 8.0		19.5 / 10.0		19.0 / 10.0						
	Inrush Current (100/200VAC)(typ) (*3)	A	20 / 40										
Leakage Current (100/240VAC) (*10)	mA	1.5 max											
Output	Nominal Voltage	VDC	3.3	5	6	7.5	12	15	24	36	48	60	
	Maximum Current (100/200VAC)	A	300 / 300		250 / 250	200 / 200	125 / 125	100 / 100	65 / 70	42 / 46.5	32 / 32	25.6 / 28	
	Maximum Peak Current (*13)	A	-		300	240	-		105	70	-		
	Maximum Power (100/200VAC)	W	990 / 990		1500 / 1500				1560 / 1680		1512 / 1674	1536 / 1536	1536 / 1680
	Maximum Peak Power (*13)	W	-		1800				-		2520		2520
	Maximum Line Regulation (*5)	mV	36			40		48	60	96	144	192	240
	Maximum Load Regulation (*6)	mV	60			-		72	90	144	150	288	360
	Temperature Coefficient		Less than 0.02%/°C										
	Maximum Ripple & Noise (*4)	+25 to +70°C	mVp-p	150						200		400	
		0°C	mVp-p	200				150		200		400	
		-10°C	mVp-p	220						200		240	400
	Hold-up Time (typ) (*9)	ms	20			16		20					
	Voltage Adjustable Range	VDC	2.64 - 3.96	4.0 - 6.0	4.8 - 7.2	6.0 - 9.0	9.6 - 14.4	12.0 - 18.0	19.2 - 28.8	28.8 - 43.2	38.4 - 52.8	48.0 - 66.0	
Function	Over Current Protection (*7)	A	>315.0		>262.5	>210.0	>131.2	>105.0	>68.2	>44.1	>33.6	>26.8	
	Over Voltage Protection (*8)	VDC	4.12 - 4.62	6.25 - 7.0	7.5 - 8.4	9.37 - 10.5	15.0 - 17.4	18.7 - 21.8	30.0 - 34.8	45.0 - 49.7	55.2 - 64.8	69.0 - 75.0	
	Remote Sensing		Possible										
	Remote ON/OFF Control		Possible										
	Parallel Operation		Possible										
	Series Operation		Possible										
	Monitoring Signal		PF (Open collector output)										
	Line DIP		Built to meet SEMI-F47 (200VAC Line only)										
Environment	Operating Temperature (*11)	°C	-10 to +70, start up -20 to +70										
	at Input Voltage 100VAC/200VAC	-10 to +40°C	W	990		1500				1560 / 1680	1512 / 1674	1536	1536 / 1680
		+50°C	W	825	1250	1500				1560 / 1680	1512 / 1674	1536	1536 / 1680
		+60°C	W	660	1000	1125				1170 / 1260	1134 / 1255	1152	1152 / 1260
		+70°C	W	495	750						780 / 840	756 / 837	768
Storage Temperature	°C	-30 to +85											
Operating Humidity	%RH	10 - 90 (No Condensing)											
Storage Humidity	%RH	10 - 95 (No Condensing)											
Vibration		At no operating, 10 - 55Hz (sweep for 1min.) 19.6m/s ² constant, X, Y, Z 1hour each.											
Shock (In package)		Less than 196.1m/s ²											
Cooling		Forced air by blower fan											
Isolation	Withstand Voltage		Input - FG : 2kVAC (20mA), Input - Output : 3kVAC (20mA), Output - CNT : 100VAC (100mA) Output - FG : 500VAC (300mA), (60V model 651VAC (390mA)) for 1min.										
	Isolation Resistance		More than 100MΩ Output - FG : 500VDC More than 10MΩ Output - CNT 100VDC at 25°C and 70%RH										
Standards	Safety Standards (*12)		Approved by UL60950-1, CSA C22.2 No.60950-1, EN60950-1, EN50178. Built to meet DENAN.										
	PFHC		Built to meet IEC61000-3-2										
	EMI		Built to meet EN55011/EN55022-A, FCC-ClassA, VCCI-ClassA.										
Immunity		Built to meet IEC61000-4-2(Level 2,3), -3(Level 3), -4(Level 3), -5(Level 3,4), -6(Level 3,4), -8(Level 4), -11											
Mechanical	Weight (typ)	g	4000					3800					
	Size (W x H x D)	mm	126.5 x 82 x 280 (Refer to outline drawing)										

(*1) At Ta=25°C and maximum output power.

(*2) For cases where conformance to various safety specs (UL, CSA, EN) are required, input voltage range will be 100 - 240VAC (50/60Hz).

(*3) First in-rush current. Not applicable to the first 0.2ms in-rush current flowing into the power supply noise filter.

(*4) Measure with JEITA RC-9131A probe, bandwidth of scope: 100MHz.

(at 100uF electric capacitor and 0.47uF film capacitor on the test fixture board.)

Ripple noise spec for ambient temperature between -10 to 25 is a linearity value with respect to the -10 degrees C and 25 degrees C specs.

(*5) 85 - 265VAC, constant load.

(*6) No load-Full load, constant input voltage.

(*7) Constant current limit with automatic recovery. Over current condition for more than 5 seconds will cause the output to shutdown. Output current exceeding maximum rated output current for more then 10 seconds continuously will result to output shutdown.

(*8) OVP circuit will shut down output, manual reset (power cycle) or ON/OFF CNT signal reset.

(*9) At 100/200VAC, nominal output voltage and maximum output current.

(*10) Measured by the each measuring method of UL, CSA, EN and DENAN (at 60Hz), Ta=25 .

(*11) Ratings - Derating at standard mounting.

- Load (%) is percent of maximum output power or maximum output current, whichever is greater.

- As for other mountings, refer to derating curve.

(*12) As for DENAN, built to meet at 100VAC.

(*13) Peak output current is less than 10 seconds, and duty 35% max. (200VAC Line only)

Recommended EMC Filter



RSEN-2030

Please refer to "TDK-Lambda EMC Filters" catalog.

Outline Drawing

[HWS1500]

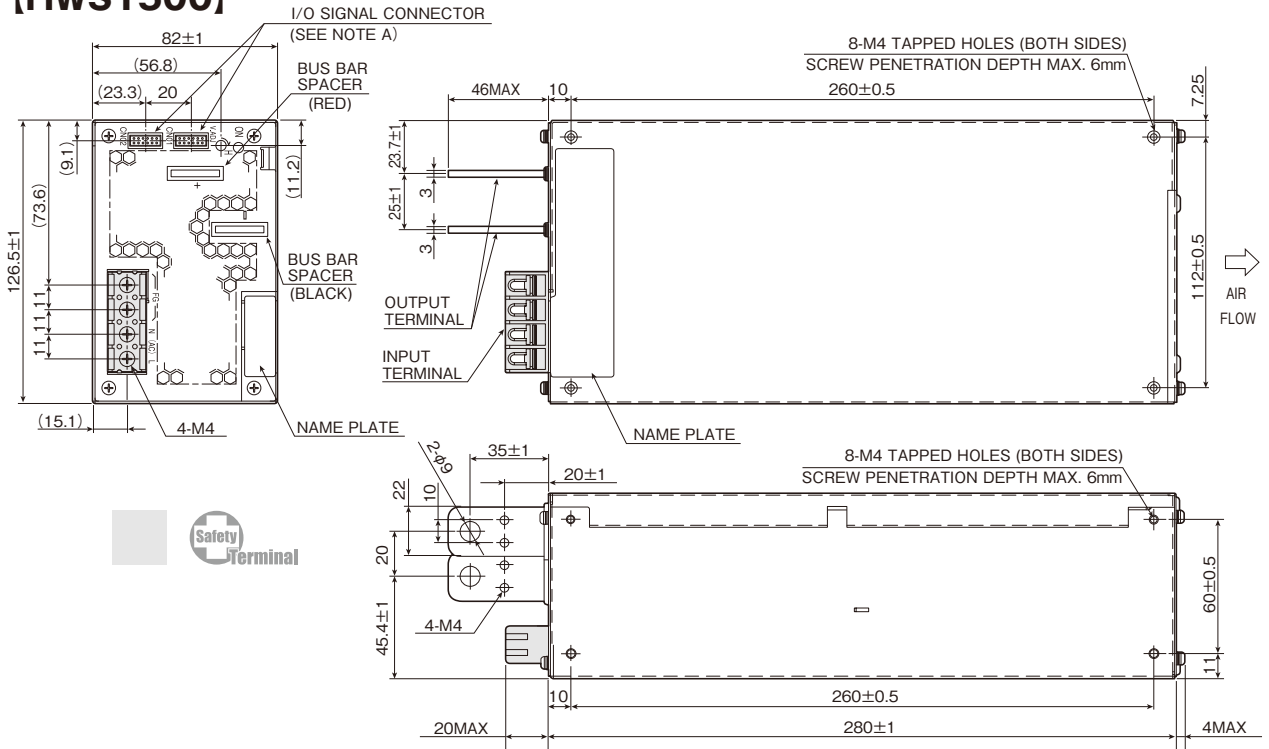

[unit: mm]
[Chassis material:SPCC-SD]

NOTES

- A : I/O SIGNAL CONNECTOR
- CONNECTOR : S12B-PHDSS (LF) (SN) (JST)
 - MATCHING HOUSING : PHDR-12VS (JST)
 - MATCHING CONTACT : SPHD-002T-P0.5 (AWG28 - 24) (JST) OR SPHD-001T-P0.5 (AWG26 - 22) (JST) OR BPHD-001T-P0.5 (AWG26 - 22) (JST)
 - HAND CRIMPING TOOL : YRS-620 (SPHD-002T-P0.5) (JST) YC-610R (SPHD-001T-P0.5) (JST) YC-610R (BPHD-001T-P0.5) (JST)

ACCESSORIES

- * ATTACHED CONNECTOR SHORTING +S ~ +V, -S ~ -V, PV ~ REF & CNT ~ TOG ATTACHED ON CN01 AT SHIPMENT
- * A separate connector not included is required in order to utilize the power supply function.

Output Derating

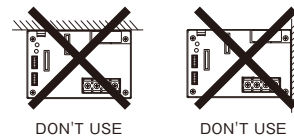
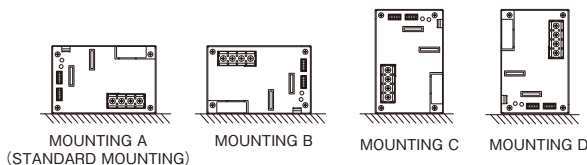
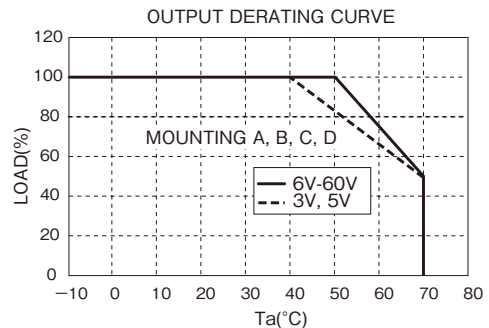
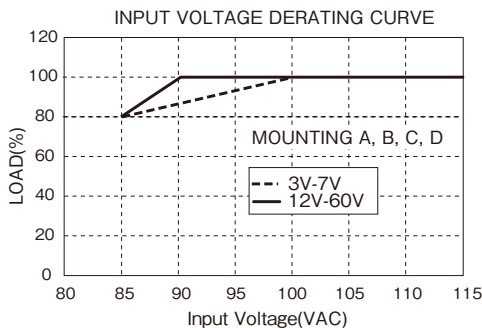

*It cannot be used even the product is flipped vertically.

HWS1800T Specifications (Read instruction manual carefully, before using the power supply unit.)

ITEMS/UNITS		MODEL	HWS1800T-3	HWS1800T-5	HWS1800T-6	HWS1800T-7	HWS1800T-12	HWS1800T-15	HWS1800T-24	HWS1800T-36	HWS1800T-48	HWS1800T-60			
Input	Voltage Range (*2)	V	3φ AC170 - 265												
	Frequency (*2)	Hz	47 - 63												
	Power Factor (200VAC)(typ) (*1)		0.94												
	Efficiency (200VAC)(typ) (*1)	%	75	81	82	84				88	90				
	Current (200VAC)(typ) (*1)	A	4.5	6.0						7.0					
	Inrush Current (200VAC)(typ) (*3)	A	40												
Leakage Current (240VAC) (*10)	mA	2.6 max													
Output	Nominal Voltage	VDC	3.3	5	6	7.5	12	15	24	36	48	60			
	Maximum Current	A	300		250	200	125	100	75	50	37.5	30			
	Maximum Peak Current (*12)	A	-		300	240	150	120	105	70	52.5	42			
	Maximum Power	W	990	1500						1800					
	Maximum Peak Power (*12)	W	-		1800				2520						
	Maximum Line Regulation (*5)	mV	36			40		48	60	96	144	192	240		
	Maximum Load Regulation (*6)	mV	60						72	90	144	216	288	360	
	Temperature Coefficient		Less than 0.02%/°C												
	Ripple & Noise (*4)	+25 to +71°C	mVp-p	150				200		250		300	400		
		0°C	mVp-p	200						250		300		400	
		-10°C	mVp-p	220				250		300		400	600		
		Hold-up Time (typ) (*9)	ms	20						18					
Voltage Adjustable Range	VDC	2.64-3.96	4.0-6.0	4.8-7.2	6.0-9.0	9.6-14.4	12.0-18.0	19.2-28.8	28.8-43.2	38.4-52.8	48.0-66.0				
Over Current Protection (*7)	A	>315.0		>303.0	>242.4	>151.5	>121.2	>106.0	>70.7	>53.0	>42.4				
Over Voltage Protection (*8)	VDC	4.12-4.62	6.25-7.0	7.5-8.4	9.37-10.5	15.0-17.4	18.7-21.8	30.0-34.8	45.0-49.7	55.2-60.0	69.0-75.0				
Function	Remote Sensing		Possible												
	Remote ON/OFF Control		Possible												
	Output Voltage External Control		Possible												
	Parallel Operation		Possible												
	Series Operation		Possible												
	Monitoring Signal		PF (Open collector output)												
	Line DIP		Built to meet SEMI-F47												
Environment	Operating Temperature (*11)	°C	-10 to +71, Start up -20 to +71												
		-10 to +40°C	W	990	1500						1800				
		+50°C	W	825	1250	1500				1680					
		+60°C	W	660	1000	1125				1300					
	+71°C	W	495	750						900					
	Storage Temperature	°C	-30 to +85												
Operating Humidity	%RH	10 - 90 (No Condensing)													
Storage Humidity	%RH	10 - 95 (No Condensing)													
Vibration		At no operating, 10 - 55Hz (sweep for 1min.) 19.6m/s ² constant, X, Y, Z 1hour each.													
Shock (In package)		Less than 196.1m/s ²													
Cooling		Forced air by blower fan													
Isolation	Withstand Voltage		Input - FG : 2kVAC (20mA), Input - Output : 3kVAC (20mA), Output-FG : 500VAC (300mA), (60V model 651VAC(390mA)), Output-CNT:100VAC (100mA) for 1min												
	Isolation Resistance		More than 100MΩ Output - FG : 500VDC More than 10MΩ Output - CNT 100VDC at 25°C and 70%RH												
Standards	Safety Standards		Approved by UL60950-1, CSA C22.2 No.60950-1, EN60950-1												
	EMI		Built to meet EN55011/EN55022-A, FCC-ClassA, VCCI-ClassA.												
	Immunity		Built to meet IEC61000-4-2(Level 2,3), -3(Level 3), -4(Level 3), -5(Level 3,4), -6(Level 3), -8(Level 4), -11												
Mechanical	Weight (typ)	g	4000						3800						
	Size (W x H x D)	mm	126.5 x 82 x 280 (Refer to outline drawing)												

(*1) At Ta=25°C and maximum output power.

(*2) For cases where conformance to various safety specs (UL, CSA, EN) are required, input voltage range will be 200 - 240VAC (50/60Hz).

(*3) First in-rush current. Not applicable to the first 0.2ms in-rush current flowing into the power supply noise filter.

(*4) Measure with JEITA RC-9131A probe, bandwidth of scope: 100MHz.

(At 100uF electric capacitor and 0.47uF film capacitor on the test fixture board.)

Ripple noise spec for ambient temperature between -10 to 25 is a linearity value with respect to the -10 degrees C and 25 degrees C specs.

(*5) 170 - 265VAC, constant load.

(*6) No load-full load, constant input voltage.

(*7) Constant current limit with automatic recovery. Over current condition for more than 5 seconds will cause the output to shutdown.

Output current exceeding maximum rated output current for more than 10 seconds continuously will result to output shutdown.

(*8) OVP circuit will shut down output, manual reset (power cycle) or ON/OFF CNT signal reset.

(*9) At 200VAC(50/60Hz), nominal output voltage and maximum output current.

(*10) Measured by the each measuring method of UL, CSA and EN (at 60Hz), Ta=25°C.

(*11) Ratings - Derating at standard mounting.

- As for other mountings, refer to derating curve.

(*12) Peak output current is less than 10 seconds, and duty 35% max.

Recommended EMC Filter



RTEN-5020

Please refer to "TDK-Lambda EMC Filters" catalog.

Outline Drawing

[HWS1800T]

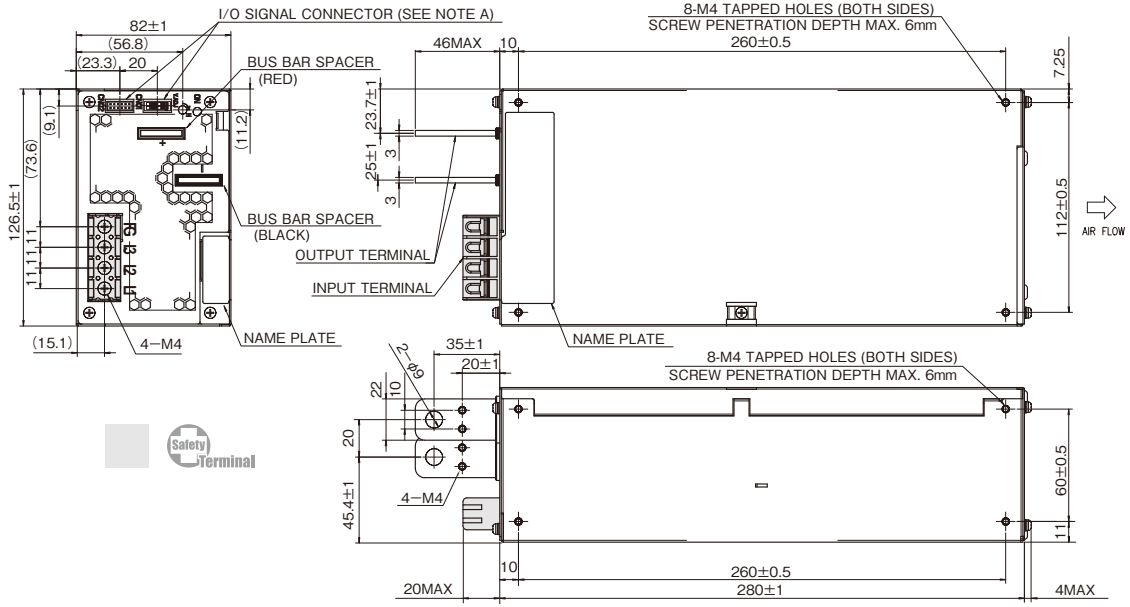

NOTES

A : I/O SIGNAL CONNECTOR

- | | | |
|--------------------|-------------------------------|----------|
| CONNECTOR | : S12B-PHDSS (LF) (SN) | (JST) |
| MATCHING HOUSING | : PHDR-12VS | (JST) |
| MATCHING CONTACT | : SPHD-002T-P0.5 (AWG28 - 24) | (JST) OR |
| | SPHD-001T-P0.5 (AWG26 - 22) | (JST) OR |
| | BPHD-001T-P0.5 (AWG26 - 22) | (JST) |
| HAND CRIMPING TOOL | : YRS-620 (SPHD-002T-P0.5) | (JST) |
| | YC-610R (SPHD-001T-P0.5) | (JST) |
| | YC-610R (BPHD-001T-P0.5) | (JST) |

ACCESSORIES

- * ATTACHED CONNECTOR (3 - 7V)
SHORTING +S ~ (+), -S ~ (-), PV ~ REF & CNT ~ TOG ATTACHED ON CN01 AT SHIPMENT
- * ATTACHED CONNECTOR (12 - 60V)
SHORTING +S ~ +V, -S ~ -V, PV ~ REF & CNT ~ TOG ATTACHED ON CN01 AT SHIPMENT
- * A separate connector not included is required in order to utilize the power supply function.

[unit: mm]
[Chassis material:SPCC-SD]

Output Derating

[HWS1800T 3V]

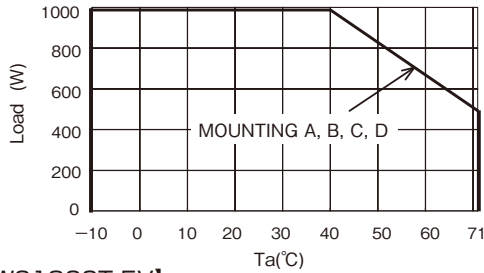

[HWS1800T 6V-15V]

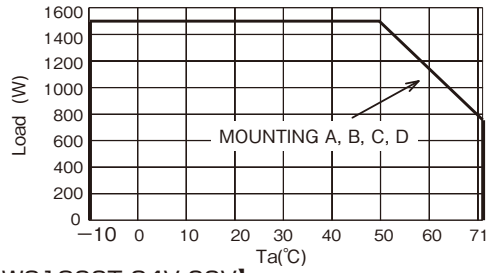

[HWS1800T 5V]

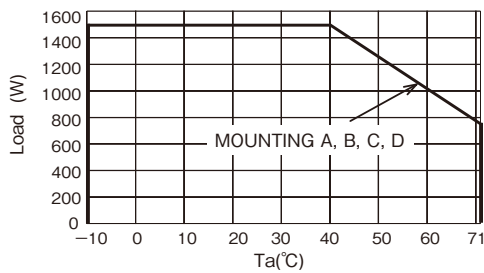

[HWS1800T 24V-60V]

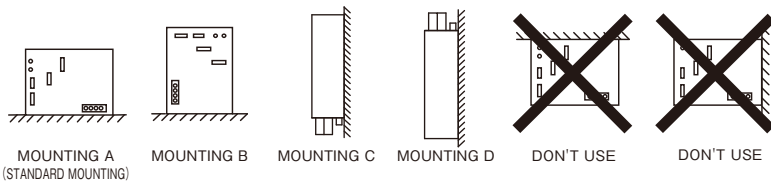
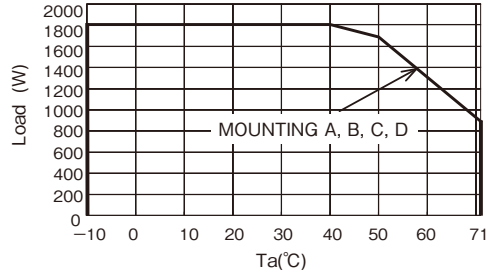

*It cannot be used even the product is flipped vertically.

TDK·Lambda

HWS/HD

Single Output 300W-1800W



Features

- Power supply for harsh environment, heavy industry equipment, etc.
 - Guaranteed start-up at $T_a = -40^{\circ}\text{C}$. (*1)
 - Internal PCB coating (*2)
 - Compliant to MIL-STD-810F, the standard for the products for military use (vibration resistance / shock resistance).
- Environmentally-friendly: High-efficiency technology reduces power loss by heat generation. Fan stopping in power-off by external control reduces acoustic noise and saves energy.
- Easy to use: All models in the same height of 82mm. Mountable in 2U-height racks without dead space.
- Safety and reliability: "Safety terminal" covering current flowing part secures safety for users. "No screw-dropping" design prevents from losing screws during maintenance operation.

Model naming method

[HWS300-1800]

HWS 300 - 5 / HD

Series name Output power

HD : With cover for harsh environment by forced air cooling

Nominal output voltage
ex. 3: 3.3V, 5: 5V, 48: 48V

Applications



Conformity to RoHS Directive

This means that, in conformity with EU Directive 2002/95/EC, lead, cadmium, mercury, hexavalent chromium, and specific bromine-based flame retardants, PBB and PBDE, have not been used, except for exempted applications.

Product Line up

Output Voltage	300W		600W	
	Output Current (Peak)	Model	Output Current (Peak)	Model
3.3V	60A	HWS300-3/HD	120A	HWS600-3/HD
5V	60A	HWS300-5/HD	120A	HWS600-5/HD
12V	27A	HWS300-12/HD	53A	HWS600-12/HD
15V	22A	HWS300-15/HD	43A	HWS600-15/HD
24V	14A (16.5A)	HWS300-24/HD	27A (31A)	HWS600-24/HD
48V	7A	HWS300-48/HD	13A	HWS600-48/HD

Output Voltage	1000W		1500W		1800W	
	Output Current (Peak)	Model	Output Current (Peak)*	Model	Output Current (Peak)	Model
3.3V	200A	HWS1000-3/HD	300A/300A	HWS1500-3/HD	300A	HWS1800T-3/HD
5V	200A	HWS1000-5/HD	300A/300A	HWS1500-5/HD	300A	HWS1800T-5/HD
6V	167A	HWS1000-6/HD	250A/250A(300A)	HWS1500-6/HD	250A (300A)	HWS1800T-6/HD
7.5V	134A (160A)	HWS1000-7/HD	200A/200A(240A)	HWS1500-7/HD	200A (240A)	HWS1800T-7/HD
12V	88A (100A)	HWS1000-12/HD	125A/125A	HWS1500-12/HD	125A (150A)	HWS1800T-12/HD
15V	70A (80A)	HWS1000-15/HD	100A/100A	HWS1500-15/HD	100A (120A)	HWS1800T-15/HD
24V	46A (58.5A)	HWS1000-24/HD	65A/70A (105A)	HWS1500-24/HD	75A (105A)	HWS1800T-24/HD
36V	30.7A (39A)	HWS1000-36/HD	42A/46.5A (70A)	HWS1500-36/HD	50A (70A)	HWS1800T-36/HD
48V	23A (29.2A)	HWS1000-48/HD	32A/32A	HWS1500-48/HD	37.5A (52.5A)	HWS1800T-48/HD
60V	18.4A (23.4A)	HWS1000-60/HD	25.6A/28A(42A)	HWS1500-60/HD	30A (42A)	HWS1800T-60/HD

(*)(100Vin/200Vin)

(*1) The power supply might not start up according to the input voltage and the load condition at the low temperature ($-40 < T_a < -10^{\circ}\text{C}$). For details, please refer to "Start-up condition at the low temperature".

(*2) For resistance against humidity, dust-related improvement-resistant, board both sides are coated. But it may not be completely possible for the effect because there is the point that is not coated partly. Please refer for the details to us.

HWS300/HD Specifications

(Read instruction manual carefully, before using the power supply unit.)

ITEMS/UNITS		MODEL	HWS300-3/HD	HWS300-5/HD	HWS300-12/HD	HWS300-15/HD	HWS300-24/HD	HWS300-48/HD
Input	Voltage Range (*3)	V	AC85 - 265 or DC120 - 330					
	Frequency (*3)	Hz	47 - 63					
	Power Factor (100/200VAC)(typ) (*2)		0.99 / 0.95					
	Efficiency (100/200VAC)(typ) (*2)		74 / 77	79 / 82	80 / 83		82 / 85	
	Current (100/200VAC)(typ) (*2)	A	2.7 / 1.4	3.8 / 1.9	4.1 / 2.1			
	Inrush Current (100/200VAC)(typ)(*4)	A	20 / 40					
Output	Leakage Current (*11)	mA	Less than 0.75. (0.2 (typ) at 100VAC / 0.44 (typ) at 230VAC)					
	Nominal Voltage	VDC	3.3	5	12	15	24	48
	Maximum Current (*1)	A	60		27	22	14 (16.5)	7
	Maximum Power	W	198	300	324	330	336	
	Maximum Line Regulation (*6)	mV	20		48	60	96	192
	Maximum Load Regulation (*7)	mV	30		72	90	144	288
	Temperature Coefficient		Less than 0.02% / °C					
	Maximum Ripple & Noise (0≤Ta≤70°C) (*5)	mVp-p	120		150		350	
	Maximum Ripple & Noise (-10≤Ta<0°C) (*5)	mVp-p	180		200		400	
	Hold-up Time (typ) (*10)	ms	20					
	Function	Voltage Adjustable Range	VDC	2.64-3.96	4.0-6.0	9.6-14.4	12.0-18.0	19.2-28.8
Over Current Protection (*8)		A	>63	>63	>28.4	>23.1	>16.7	>7.4
Over Voltage Protection (*9)		VDC	4.13-4.95	6.25-7.25	15.0-17.4	18.8-21.8	30.0-34.8	55.2-64.8
Remote Sensing			Possible					
Remote ON/OFF Control			Possible					
Parallel Operation			Possible					
Series Operation			Possible					
Monitoring Signal			PF (Open collector output)					
Line DIP			Designed to meet SEMI-F47 (200VAC Line only)					
Environment		Operating Temperature (*12)(*13)	°C	-10 to +71 (-10 to +50: 100%, +71: 50%) Guarantee Start up at -40 to -10				
	Storage Temperature	°C	-40 to +85					
	Operating Humidity	RH	10 - 90 (No dewdrop)					
	Storage Humidity	RH	10 - 95 (No dewdrop)					
	Vibration (*14)		At no operating, 10 - 55Hz (sweep for 1min) 19.6m/s ² constant, X, Y, Z 1hour each. Designed to meet MIL-STD-810F 514.5 Category 4,10					
	Shock (In package)		Less than 196.1m/s ² Designed to meet MIL-STD-810F 516.5 Procedure I, VI					
	Cooling		Forced air by blower fan					
Isolation	Withstand Voltage		Input - FG : 2.5kVAC (20mA), Input - Output : 3kVAC (20mA) Output - FG : 500VAC (100mA), Output-CNT: 100VAC(100mA) for 1min					
	Isolation Resistance		More than 100MΩ Output - FG : 500VDC More than 10MΩ Output -CNT : 100VDC at 25°C and 70%RH					
Standards	Safety Standards (*15)		Approved by UL60950-1, CSA C22.2 No.60950-1, EN60950-1, EN50178 Designed to meet DENAN					
	PFHC		Designed to meet IEC61000-3-2					
	EMI		Designed to meet EN55011/EN55022-B, FCC-B, VCCI-B					
	Immunity		Designed to meet IEC61000-4-2(Level 2,3), -3(Level 3), -4(Level 3), -5(Level 3,4), -6(Level 3), -8(Level 4), -11					
Mechanical	Weight (typ)	g	1000					
	Size (W x H x D)	mm	61 x 82 x 165 (Refer to outline drawing)					

(*1) (): Peak output current at 200VAC. Operating time at peak output is less than 10sec, duty is less than 35%.

(*2) At 100/200VAC, Ta=25°C and maximum output power.

(*3) For cases where conformance to various safety specs (UL, CSA, EN) are required, to be described as 100 - 240VAC (50/60Hz).

(*4) Not applicable for the in-rush current to noise filter for less than 0.2ms.

(*5) Measure with JEITA RC-9131A probe, bandwidth of scope :100MHz.

(*6) 85 - 265VAC, constant load.

(*7) No load-Full load, constant input voltage.

(*8) 3.3, 5V model: Constant current limit and hiccup with automatic recovery.

12 - 48V model: Constant current limit with automatic recovery.

Avoid to operate at over load or short circuit condition for more than 30 seconds.

(*9) OVP circuit will shut the output down, manual reset (CNT reset or re power on).

(*10) At 100/200VAC, nominal output voltage and maximum output current.

(*11) Measured by the each measuring method of UL, CSA, EN and DENAN (at 60Hz), Ta=25°C.

(*12) Ratings - Derating at standard mounting. Refer to output derating curve.

- Load (%) is percent of maximum output power or maximum output current, whichever is greater.

(*13) For -40°C to -10°C need 3minutes to stabilize the output voltage.

(*14) Category 4 exposure levels : Truck transportation over U.S. highways, composite two-wheeled trailer.

(*15) As for DENAN, designed to meet at 100VAC.

Recommended EMC Filter



RSEN-2006

Please refer to "TDK-Lambda EMC Filters" catalog.

Outline Drawing

[HWS300/HD]

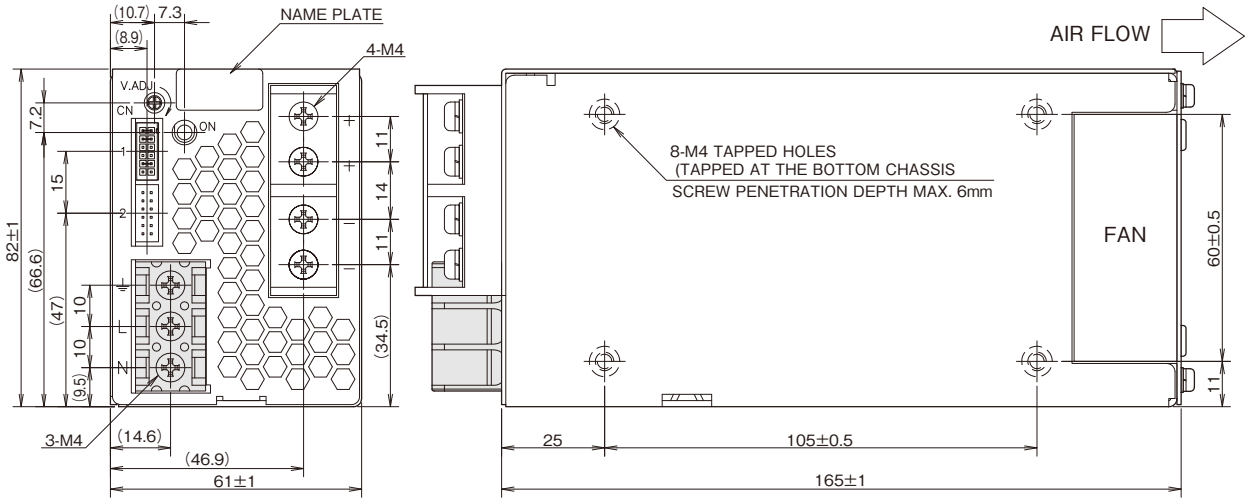

== NOTES ==

- A: MODEL NAME, NOMINAL OUTPUT VOLTAGE AND MAXIMUM OUTPUT CURRENT ARE SHOWN IN THE NAME PLATE IN ACCORDANCE WITH THE SPECIFICATIONS.
- B: M4 TAPPED HOLES (8) FOR CUSTOMER CHASSIS MOUNTING.(SCREW PENETRATION DEPTH 6m/m MAX.)

== ACCESSORIES ==

- * COVER FOR BARRIER TERMINAL STRIP -----1 (ATTACHED ON TERMINAL AT SHIPMENT)
- * SHORT PIECE -----1 SHORTING +Vm +S, -Vm -S, CNT TOG (ATTACHED ON CN1 AT SHIPMENT)

== SIGNAL CONNECTOR USED ==

PART DESCRIPTION	PART NAME
PIN HEADER	S12B-PHDSS

== MATCHING HOUSINGS , PINS & TOOL ==

PART DESCRIPTION	PART NAME	MANUFACT
SOCKET HOUSING	PHDR-12VS	JST
TERMINAL PINS	SPHD-002T-P0.5(AWG28~24) SPHD-001T-P0.5(AWG26~22)	JST
HAND CRIMPING TOOL	YRS-620(SPHD-002T-P0.5) YC-610R(SPHD-001T-P0.5)	JST

Output Derating

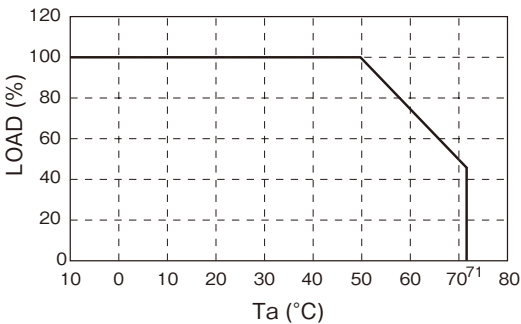

Ta(°C)	LOAD(%)	
	MOUNTING A	MOUNTING B
-10 to +50	100	
71	50	

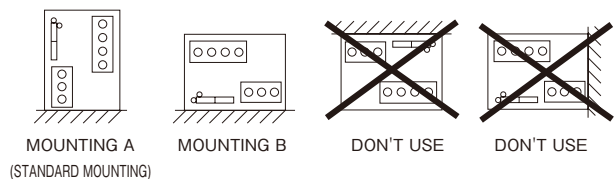

HWS600/HD Specifications (Read instruction manual carefully, before using the power supply unit.)

ITEMS/UNITS		MODEL	HWS600-3/HD	HWS600-5/HD	HWS600-12/HD	HWS600-15/HD	HWS600-24/HD	HWS600-48/HD
Input	Voltage Range (*3)	V	AC85 - 265 or DC120 - 330					
	Frequency (*3)	Hz	47 - 63					
	Power Factor (100/200VAC)(typ) (*2)		0.99 / 0.95					
	Efficiency (100/200VAC)(typ) (*2)		75 / 78	80 / 83		81 / 84	82 / 85	83 / 86
	Current (100/200VAC)(typ) (*2)	A	5.4 / 2.6	7.5 / 3.6	8.1 / 3.9			
	Inrush Current (100/200VAC)(typ)(*4)	A	20 / 40					
Output	Leakage Current (*11)	mA	Less than 0.75. (0.2 (typ) at 100VAC / 0.44 (typ) at 230VAC)					
	Nominal Voltage	VDC	3.3	5	12	15	24	48
	Maximum Current (*1)	A	120		53	43	27 (31)	13
	Maximum Power	W	396	600	636	645	648	624
	Maximum Line Regulation (*6)	mV	20		48	60	96	192
	Maximum Load Regulation (*7)	mV	30		72	90	144	288
	Temperature Coefficient		Less than 0.02% / °C					
	Maximum Ripple & Noise (0<Ta<70°C) (*5)	mVp-p	120		150		350	
	Maximum Ripple & Noise (-10≤Ta<0°C)(*5)	mVp-p	180		200		400	
	Hold-up Time (typ) (*10)	ms	20					
Function	Voltage Adjustable Range	VDC	2.64-3.96	4.0-6.0	9.6-14.4	12.0-18.0	19.2-28.8	38.4-52.8
	Over Current Protection (*8)	A	>126		>55.7	>45.2	>31.4	>13.7
	Over Voltage Protection (*9)	VDC	4.13-4.95	6.25-7.25	15.0-17.4	18.8-21.8	30.0-34.8	55.2-64.8
	Remote Sensing		Possible					
	Remote ON/OFF Control		Possible					
	Parallel Operation		Possible					
	Series Operation		Possible					
	Monitoring Signal		PF (Open Collector Output)					
Environment	Line DIP		Designed to meet SEMI-F47 (200VAC Line only)					
	Operating Temperature (*12)(*13)	°C	-10 to +71 (-10 to +50: 100%, +71: 50%) Guarantee start up at -40 to -10					
	Storage Temperature	°C	-40 to +85					
	Operating Humidity	RH	10 - 90%RH (No dewdrop)					
	Storage Humidity	RH	10 - 95%RH (No dewdrop)					
	Vibration (*14)		At no operating, 10 - 55Hz (sweep for 1min) 19.6m/s ² constant, X, Y, Z 1hour each. Designed to meet MIL-STD-810F 514.5 Category 4, 10					
Isolation	Shock (In package)		Less than 196.1m/s ² Designed to meet MIL-STD-810F 516.5 Procedure I, VI					
	Cooling		Forced air by blower fan					
	Withstand Voltage		Input - FG : 2.5kVAC (20mA), Input - Output : 3kVAC (20mA) Output - FG : 500VAC (100mA), Output - CNT : 100VAC(100mA) for 1min					
Standards	Isolation Resistance		More than 100MΩ Output - FG : 500VDC More than 10MΩ Output - CNT : 100VDC at 25°C and 70%RH					
	Safety Standards (*15)		Approved by UL60950-1, CSA C22.2 No 60950-1, EN60950-1, EN50178 Designed to meet DENAN					
	PFHC		Designed to meet IEC61000-3-2					
	EMI		Designed to meet EN55011/EN55022-B, FCC-B, VCCI-B					
Mechanical	Immunity		Designed to meet IEC61000-4-2(Level 2,3), -3(Level 3), -4(Level 3), -5(Level 3,4), -6(Level 3), -8(Level 4), -11					
	Weight (typ)	g	1600					
	Size (W x H x D)	mm	100 x 82 x 165 (Refer to outline drawing)					

(*1) (): Peak output current at 200VAC. Operating time at peak output is less than 10sec, duty is less than 35%.

(*2) At 100/200VAC, Ta=25°C and maximum output power.

(*3) For cases where conformance to various safety specs (UL, CSA, EN) are required, to be described as 100 - 240VAC (50/60Hz).

(*4) Not applicable for the in-rush current to noise filter for less than 0.2ms.
Inrush Current is 30A (typ) when PFHC start-up.

(*5) Measure with JEITA RC-9131A probe, bandwidth of scope : 100MHz.

(*6) 85 - 265VAC, constant load.

(*7) No load - Full load, constant input voltage.

(*8) 3V and 5V model: Constant current limit and hiccup with automatic recovery.

12 - 48V model: Constant current limit with automatic recovery.

Avoid to operate at over load or short circuit condition for more than 30 seconds.

(*9) OVP circuit will shut the output down, manual reset (CNT reset or Re-power on).

(*10) At 100/200VAC, nominal output voltage and maximum output current.

(*11) Measured by the each measuring method of UL, CSA, EN and DENAN (at 60Hz, Ta=25°C).

(*12) Ratings - Derating at standard mounting. Refer to output derating curve.

- Load (%) is percent of maximum output power or maximum output current, whichever is greater.

(*13) For -40°C to -10°C need 3 minutes to stabilize the output voltage.

(*14) Category 4 exposure levels : Truck transportation over U.S. highways, composite two-wheeled trailer.

(*15) As for DENAN, designed to meet at 100VAC.

Recommended EMC Filter



RSEN-2016

Please refer to "TDK-Lambda EMC Filters" catalog.

Outline Drawing

[HWS600/HD]

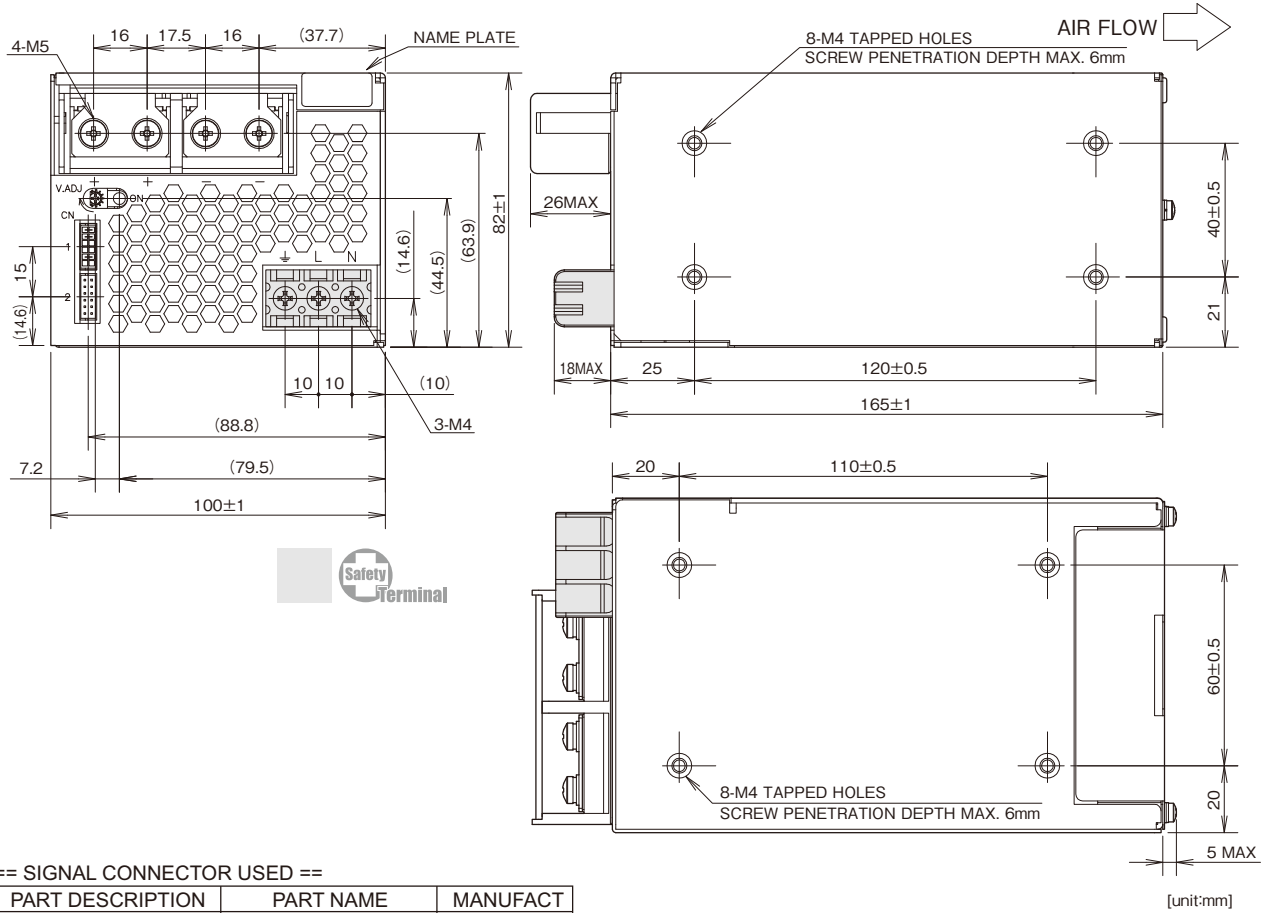

== SIGNAL CONNECTOR USED ==

PART DESCRIPTION	PART NAME	MANUFACT
PIN HEADER	S12B-PHDSS	JST

== MATCHING HOUSINGS, PINS & TOOL ==

PART DESCRIPTION	PART NAME	MANUFACT
SOCKET HOUSING	PHDR-12VS	JST
TERMINAL PINS	SPHD-002T-P0.5(AWG28~24) SPHD-001T-P0.5(AWG26~22)	JST
HAND CRIMPING TOOL	YRS-620(SPHD-002T-P0.5) YC-610R(SPHD-001T-P0.5)	JST

== ACCESSORIES ==

- * COVER FOR BARRIER TERMINAL STRIP -----1
(ATTACHED ON TERMINAL AT SHIPMENT)
- * SHORT PIECE -----1
SHORTING +Vm - +S, -Vm - -S, CNT TOG
(ATTACHED ON CN1 AT SHIPMENT)

Output Derating

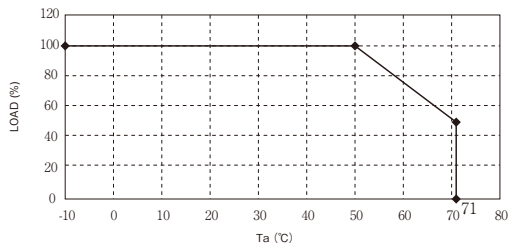

Ta(°C)	LOAD(%)	
	MOUNTING A	MOUNTING B
-10 to +50	100	
71	50	

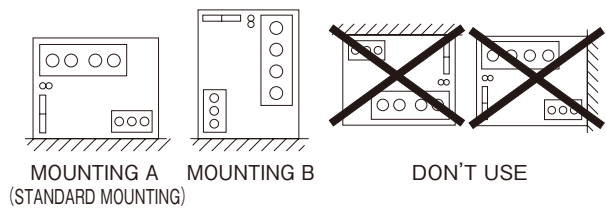

HWS1000/HD Specifications(Read instruction manual carefully, before using the power supply unit.)

ITEMS/UNITS		MODEL	HWS1000 -3/HD	HWS1000 -5/HD	HWS1000 -6/HD	HWS1000 -7/HD	HWS1000 -12/HD	HWS1000 -15/HD	HWS1000 -24/HD	HWS1000 -36/HD	HWS1000 -48/HD	HWS1000 -60/HD	
Input	Voltage Range (*2)	V	AC85 - 265 or DC120 - 330										
	Frequency (*2)	Hz	47 - 63										
	Power Factor (100/200VAC)(typ) (*1)		0.98/0.95										
	Efficiency (100/200VAC)(typ) (*1)	%	71/73	76/78	79/81	80/82	82/85	83/85	85/87	85/88	86/88	85/88	
	Current (100/200VAC)(typ) (*1)	A	9.6/5.0 13.5/7.0										
	Inrush Current (100/200VAC)(typ) (*3)	A	20/40										
Output	Leakage Current (100/240VAC)(*10)	mA	1.2 max										
	Nominal Voltage	VDC	3.3	5	6	7.5	12	15	24	36	48	60	
	Maximum Current	A	200		167	134	88	70	46	30.7	23	18.4	
	Maximum Peak Current (*13)	A	-		160	100	80	58.5	39	29.2	23.4		
	Maximum Power	W	660	1000	1002	1005	1056	1050	1104				
	Maximum Peak Power (*13)	W	-		1200				1404				
	Maximum Line Regulation (*5)	mV	20		36		48	60	96	144	192	240	
	Maximum Load Regulation (*6)	mV	40		60		100	120	150		300	360	
	Temperature Coefficient		Less than 0.02% / °C										
	Maximum Ripple & Noise (*4)	0 to +71°C mVp-p -10 to 0°C mVp-p	120 160					150 180		200 240		400 600	
	Hold-up Time (typ) (*9)	ms	20										
Function	Voltage Adjustable Range	VDC	2.64-3.96	4.0-6.0	4.8-7.2	6.0-9.0	9.6-14.4	12.0-18.0	19.2-28.8	28.8-43.2	38.4-52.8	48.0-66.0	
	Over Current Protection (*7)	A	>210.0	>175.3	>168.0	>105.0	>84.0	>61.4	>40.9	>30.6	>24.5		
	Over Voltage Protection (*8)	VDC	4.12-4.62	6.25-7.0	7.5-8.4	9.37-10.5	15.0-17.4	18.7-21.8	30.0-34.8	45.0-49.7	55.2-60.0	69.0-75.0	
	Remote Sensing		Possible										
	Remote ON/OFF Control		Possible										
	Parallel Operation		Possible										
	Series Operation		Possible										
	Monitoring Signal		PF(Open collector output)										
	Line DIP		Built to meet SEMI-F47 (200VAC Line only)										
	Other Function		PCB Coating on solder side and component side.										
Environment	Operating Temperature (*11)	°C	-10 to +71, Guarantee Start up -40 to -10										
		-10 to +40°C %	100										
		+50°C %	83.9		100								
		+71°C %	50										
	Storage Temperature	°C	-40 to +85										
	Operating Humidity	%RH	10 - 90 (No Condensing)										
	Storage Humidity	%RH	10 - 95 (No Condensing)										
Isolation	Vibration (*14)(*15)		At no operating, 10 - 55Hz (Sweep for 1min.) 19.6m/s² Constant, X,Y,Z 1hour each. Designed to meet MIL-STD-810F 514.5 Category 4 figure 514.5C-1, category 10										
	Shock (In package) (*15)		Less than 196.1m/s² Designed to meet MIL-STD-810F 516.5 Procedure I										
	Cooling		Forced Air By Blower Fan										
	Withstand Voltage		Input - FG : 2kVAC (20mA), Input - Output : 3kVAC (20mA) Output - FG : 500VAC (300mA), (60V model 651VAC(390mA)), Output - CNT:100VAC (100mA) for 1min										
Standards	Isolation Resistance		More than 100MΩ Output - FG : 500VDC More than 10MΩ Output - CNT : 100VDC at 25°C and 70%RH										
	Safety Standards (*12)		Approved by UL60950-1, CSA C22.2 No.60950-1, EN60950-1, EN50178. Built to meet DENAN.										
	PFHC		Built to meet IEC61000-3-2										
	EMI		Built to meet EN55011/EN55022-B, FCC-ClassB, VCCI-ClassB, CISPR-ClassB.										
Mechanical	Immunity		Built to meet IEC61000-4-2(Level 2,3), -3(Level 3), -4(Level 3), -5(Level 3,4), -6(Level 3), -8(Level 4), -11										
	Weight (max)	g	3200										
	Size (W×H×D)	mm	126.5 x 82 x 240 (Refer to outline drawing)										

(*1) At Ta=25°C and maximum output power.

(*2) For cases where conformance to various safety specs (UL, CSA,EN) are required, input voltage range will be 100 - 240VAC(50/60Hz).

(*3) First in-rush current. Not applicable to the first 0.2ms in-rush current flowing into the power supply noise filter.

(*4) Measure with JEITA RC-9131A probe, Bandwidth of scope :100MHz. (at 100uF electric capacitor and 0.47uF film capacitor on the test fixture board

(*5) 85 - 265VAC , constant load.

(*6) No load-Full load, constant input voltage.

(*7) Constant current limit with automatic recovery. Over current condition for more than 5 seconds will cause the output to shutdown. Output current exceeding maximum rated output current for more than 10 seconds continuously will result to output shutdown.

(*8) OVP circuit will shut down output, manual reset (Power cycle) or ON/OFF CNT signal reset.

(*9) At 100/200VAC, nominal output voltage and maximum output current.

(*10) Measured by the each measuring method of UL, CSA, EN and DENAN(at 60Hz), Ta=25°C.

(*11) Ratings - Derating at standard mounting.

- Load (%) is percent of maximum output power or maximum output current, whichever is greater.

- As for other mountings, refer to derating curve.

- For conditions of start up at -40°C to 10°C, refer to derating curve.

(*12) As for DENAN, built to meet at 100VAC.

(*13) Peak output current is less than 10 seconds, and duty 35% max.(200VAC Line only)

(*14) Category 4 exposure levels : Truck transportation over U.S. highways, Composite two-wheeled trailer.

(*15) It is compulsory to fix BRACKET onto product for MIL-STD-810F 516.5 Procedure I and MIL-STD-810F 514.5 category 10 compliance. Refer to mounting method.

● Recommended EMC Filter



RSEN-2016

Please refer to "TDK-Lambda EMC Filters" catalog.

Please refer to page a_HWS_24 for MIL-STD Mounting

Outline Drawing

[HWS1000/HD]

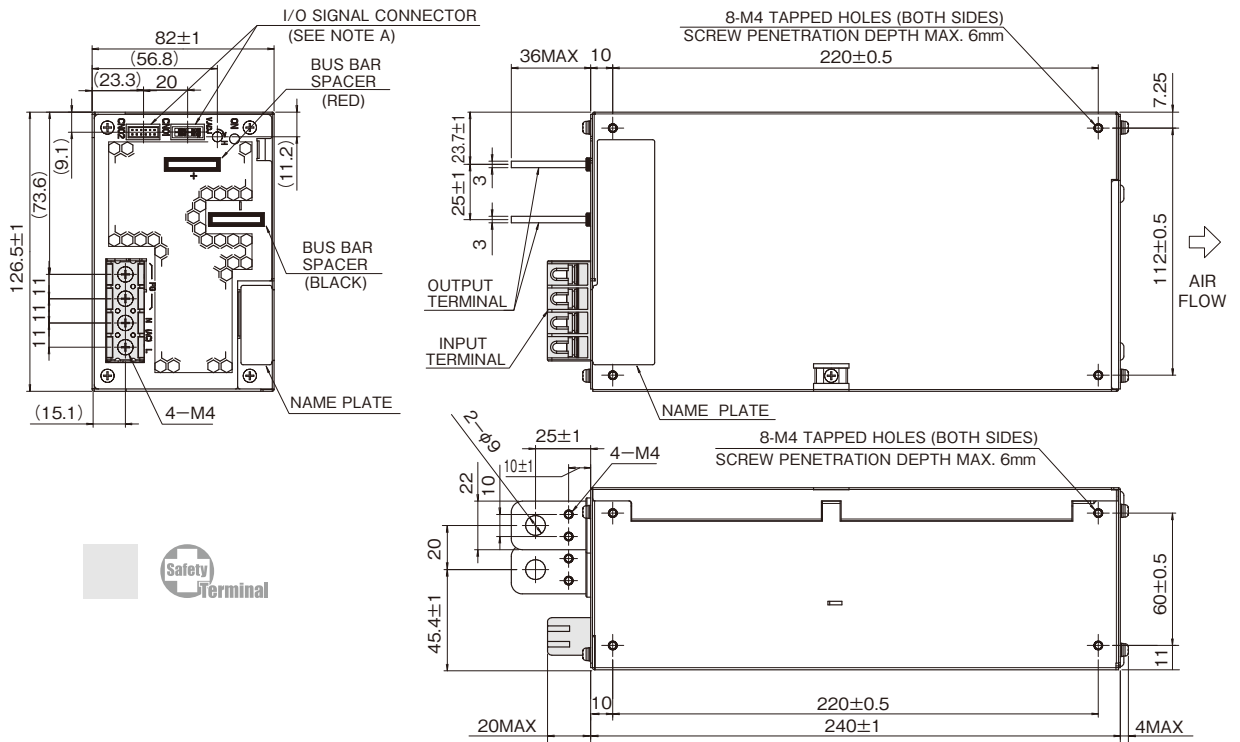

NOTES

- A: I/O SIGNAL CONNECTOR**
- CONNECTOR : S12B-PHDSS(LF)(SN) (JST)
 - MATCHING HOUSING : PHDR-12VS (JST)
 - MATCHING CONTACT : SPHD-002T-P0.5(AWG28~24) (JST) OR SPHD-001T-P0.5(AWG26~22) (JST) OR BPHD-001T-P0.5(AWG26~22) (JST)
 - HAND CRIMPING TOOL : YRS-620(SPHD-002T-P0.5) (JST) YC-610R(SPHD-001T-P0.5) (JST) YC-610R(BPHD-001T-P0.5) (JST)

ACCESSORIES

- * ATTACHED CONNECTOR (3~7V) SHORTING +S~+V, -S~-V, PV~REF & CNT~TOG ATTACHED ON CN01 AT SHIPMENT
- * ATTACHED CONNECTOR (12..60V) SHORTING +S~+V, -S~-V, PV~REF & CNT~TOG ATTACHED ON CN01 AT SHIPMENT
- * A separate connector not included is required in order to utilize the power supply function.

[unit: mm]
[Chassis material:SPCC-SD]

Output Derating

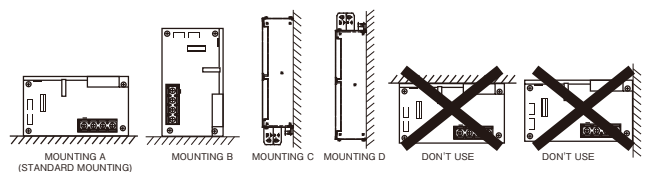
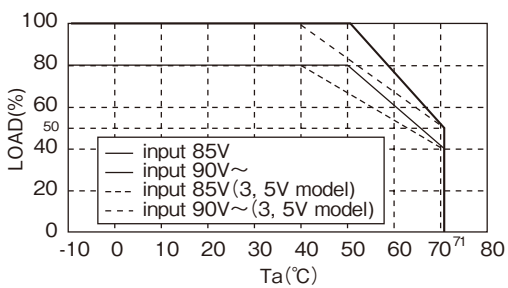

*It cannot be used even the product is flipped vertically.

Start-up condition at low temperature

●DERATING TO START UP AT Ta : -40 to -10° C

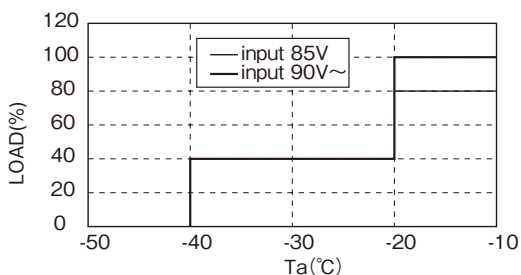

=NOTES=

- 1) Input voltage: Not gradual start up.
- 2) No Condensing.

HWS1500/HD Specifications(Read instruction manual carefully, before using the power supply unit.)

HWS

HWS HD

HWS ME

HWS-P

Instruction Manual

ITEMS/UNITS		MODEL	HWS1500 -3/HD	HWS1500 -5/HD	HWS1500 -6/HD	HWS1500 -7/HD	HWS1500 -12/HD	HWS1500 -15/HD	HWS1500 -24/HD	HWS1500 -36/HD	HWS1500 -48/HD	HWS1500 -60/HD			
Input	Voltage Range (*2)	V	AC85 - 265												
	Frequency (*2)	Hz	47 - 63												
	Power Factor (100/230VAC)(typ) (*1)		0.98 / 0.94												
	Efficiency (100/200VAC)(typ) (*1)		72 / 75	77 / 81	79 / 82	81 / 83	82 / 85	83 / 87	84 / 88		86 / 90				
	Current (100/200VAC)(typ) (*1)	A	15.0 / 8.0		19.5 / 10.0		19.0 / 10.0								
	Inrush Current (100/200VAC)(typ) (*3)	A	20 / 40												
	Leakage Current (100/240VAC) (*10)	mA	1.5 max												
Output	Nominal Voltage	V	3.3	5	6	7.5	12	15	24	36	48	60			
	Maximum Current (100/200VAC)	A	300 / 300		250 / 250	200 / 200	125 / 125	100 / 100	65 / 70	42 / 46.5	32 / 32	25.6 / 28			
	Maximum Peak Current (*13)	A	-		300	240	-		105	70	-				
	Maximum Power (100VAC/200VAC)	W	990/990		1500/1500			-		1560/1680	1512/1674	1536/1536	1536/1680		
	Maximum Peak Power (*13)	W	-		1800			-		2520		-			
	Maximum Line Regulation (*5)	mV	36			40			48	60	96	144	192	240	
	Maximum Load Regulation (*6)	mV	60			72			90	144	150	288	360		
	Temperature Coefficient		Less than 0.02%/°C												
	Ripple & Noise (*4)	+25 to +71°C	mVp-p	150				200				400			
		0°C	mVp-p	200				150				200			
		-10°C	mVp-p	220				200				240	400	600	
Hold-up Time (typ) (*9)	ms	20			16			20							
Voltage Adjustable Range	VDC	2.64 - 3.96	4.0 - 6.0	4.8 - 7.2	6.0 - 9.0	9.6 - 14.4	12.0 - 18.0	19.2 - 28.8	28.8 - 43.2	38.4 - 52.8	48.0 - 66.0				
Over Current Protection (*7)	A	> 315.0		> 262.5	> 210.0	> 131.2	> 105.0	> 68.2	> 44.1	> 33.6	> 26.8				
Over Voltage Protection (*8)	VDC	4.12 - 4.62	6.25 - 7.0	7.5 - 8.4	9.37 - 10.5	15.0 - 17.4	18.7 - 21.8	30.0 - 34.8	45.0 - 49.7	55.2 - 64.8	69.0 - 75.0				
Remote Sensing		Possible													
Remote ON/OFF Control		Possible													
Parallel Operation		Possible													
Series Operation		Possible													
Monitoring Signal		PF (Open collector output)													
Line DIP		Designed to meet SEMI-F47 (200VAC Line only)													
Other Function		PCB Coating on solder side and component side.													
Environment	Operating Temperature (*11)	°C	-10 to +71, Guarantee start up at -40 to -10												
	at Input Voltage 100VAC/200VAC	-10 to +40°C	W	990		1500			1560 / 1680		1512 / 1674	1536	1536 / 1680		
		+50°C	W	825	1250	1500			1560 / 1680		1512 / 1674	1536	1536 / 1680		
		+60°C	W	660	1000	1125			1170 / 1260		1134 / 1255	1152	1152 / 1260		
		+71°C	W	495	750			780 / 840		756 / 837	768	768 / 840			
	Storage Temperature	°C	-40 to +85												
Operating Humidity	RH	10 - 90 (No Condensing)													
Storage Humidity	RH	10 - 95 (No Condensing)													
Vibration (*14)(*15)		At no operating, 10 - 55Hz (sweep for 1min.) 19.6m/s ² constant, X,Y,Z 1hour each. Designed to meet MIL-STD-810F 514.5 Category 4 figure 514.5C-1 and Category 10													
Shock (In package) (*15)		Less than 196.1m/s ² Designed to meet MIL-STD-810F 516.5 Procedure I													
Cooling		Forced air by blower fan													
Isolation	Withstand Voltage		Input - FG : 2kVAC (20mA), Input - Output : 3kVAC (20mA), Output - CNT : 100VAC (100mA) Output - FG : 500VAC (300mA), (60V model 651VAC (390mA)) for 1min.												
	Isolation Resistance		More than 100MΩ Output - FG : 500VDC More than 10MΩ Output - CNT : 100VDC at 25°C and 70%RH												
Standards	Safety Standards (*12)		Approved by UL60950-1, CSA C22.2 No.,60950-1, EN60950-1, EN50178. Designed to meet DENAN.												
	PFHC		Designed to meet IEC61000-3-2												
	EMI		Designed to meet EN55011/EN55022-A, FCC-ClassA, VCCI-ClassA.												
Mechanical	Immunity		Designed to meet IEC61000-4-2(Level 2,3), -3(Level 3), -4(Level 3), -5(Level 3,4), -6(Level 3), -8(Level 4), -11												
	Weight (typ)	g	4000						3800						
Size (W x H x D)	mm	126.5 x 82 x 280 (Refer to outline drawing)													

(*1) At Ta=25°C and maximum output power.

(*2) For cases where conformance to various safety specs (UL, CSA, EN) are required, input voltage range will be 100 - 240VAC (50/60Hz).

(*3) First in-rush current. Not applicable to the first 0.2ms in-rush current flowing into the power supply noise filter.

(*4) Measure with JEITA RC-9131A probe, bandwidth of scope :100MHz. at 100uF electric capacitor and 0.47uF film capacitor on the test fixture board.)

Ripple noise spec for ambient temperature between -10 to 25 is a linearity value with respect to the -10 degrees C and 25 degrees C specs.

(*5) 85 - 265VAC , constant load.

(*6) No load-full load, constant input voltage.

(*7) Constant current limit with automatic recovery. Over current condition for more than 5 seconds will cause the output to shutdown. Output current exceeding maximum rated output current for more than 10 seconds continuously will result to output shutdown.

(*8) OVP circuit will shut down output, manual reset (power cycle) or ON/OFF CNT signal reset.

(*9) At 100/200VAC, nominal output voltage and maximum output current.

(*10) Measured by the each measuring method of UL, CSA, EN and DENAN (at 60Hz, Ta=25°C.

(*11) Ratings - Derating at standard mounting.

- Load (%) is percent of maximum output power or maximum output current, whichever is greater.

- As for other mountings, refer to derating curve.

- For conditions of start up at -40°C to -10°C, refer to derating curve.

(*12) As for DENAN, designed to meet at 100VAC.

(*13) Peak output current is less than 10 seconds, and duty 35% max.(200VAC Line only)

(*14) Category 4 exposure levels : Track transportation over U.S. highways.

(*15) It is compulsory to fix BRACKET onto product for MIL-STD-810F 516.5 Procedure I and MIL-STD-810F 514.5 category 10 compliance. Refer to mounting method.

Recommended EMC Filter



RSEN-2030

Please refer to "TDK-Lambda EMC Filters" catalog.

Please refer to page a_HWS_24 for MIL-STD Mounting

Outline Drawing

[HWS1500/HD]

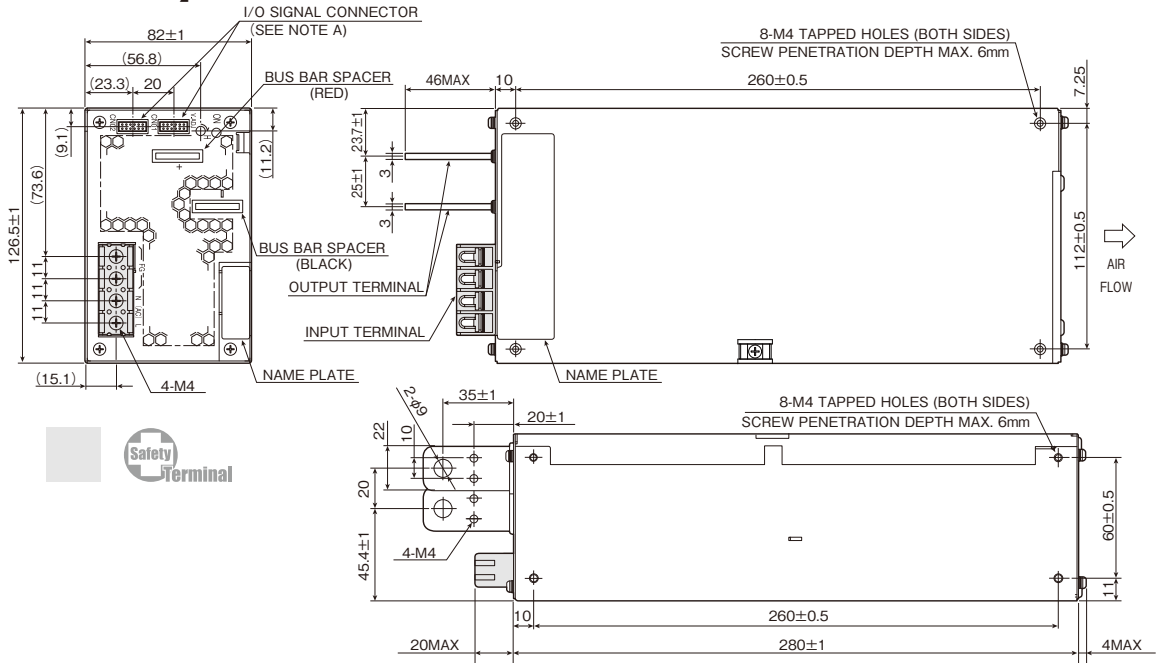

NOTES

- A: I/O SIGNAL CONNECTOR
 CONNECTOR : S12B-PHDSS(LF)(SN) (JST)
 MATCHING HOUSING : PHDR-12VS (JST)
 MATCHING CONTACT : SPHD-002T-P0.5(AWG28~24) (JST) OR
 SPHD-001T-P0.5(AWG26~22) (JST) OR
 BPHD-001T-P0.5(AWG26~22) (JST)
 HAND CRIMPING TOOL : YRS-620(SPHD-002T-P0.5) (JST)
 YC-610R(SPHD-001T-P0.5) (JST)
 YC-610R(BPHD-001T-P0.5) (JST)

ACCESSORIES

- * ATTACHED CONNECTOR (3~7V)
 SHORTING +S~(+), -S~(-), PV~REF & CNT~TOG
 ATTACHED ON CN01 AT SHIPMENT
- * ATTACHED CONNECTOR (12_60V)
 SHORTING +S~+V, -S~V, PV~REF & CNT~TOG
 ATTACHED ON CN01 AT SHIPMENT
- * A separate connector not included is required in order to utilize the power supply function.

[unit: mm]
 [Chassis material:SPCC-SD]

Output Derating

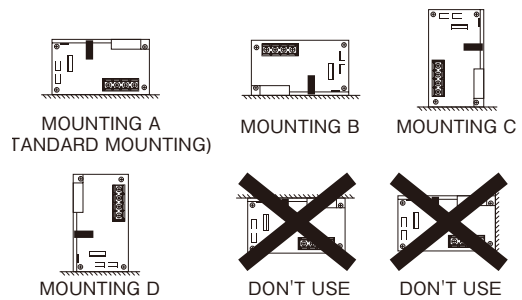
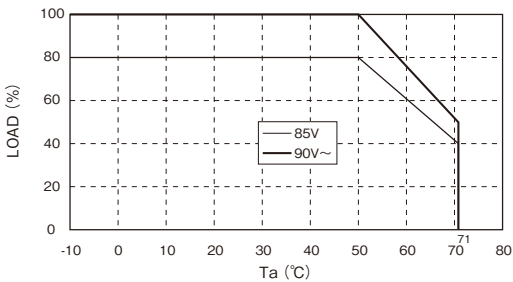

Start-up condition at low temperature

●DERATING TO START UP AT Ta : -40 to -10° C

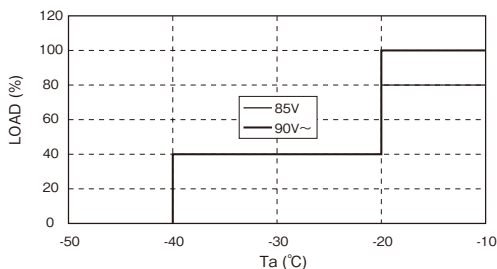

=NOTES=

- 1) Input voltage: Not gradual start up.
- 2) No condensing.
- 3) Output voltage becomes more stable by performing the following.
 - a) Electrolytic capacitor is added to an output.
 - +3.3V, +5V, +6V : LXZ 10V 5600uF (NIPPON CHEMI-CON) x 3 parallel
 - +7.5V : LXZ 16V 3900uF (NIPPON CHEMI-CON) x 3 parallel
 - +12V : LXZ 25V 2700uF (NIPPON CHEMI-CON) x3 parallel
 - +15V : LXZ 25V 2700uF (NIPPON CHEMI-CON) x3 parallel
 - +24V : LXZ 35V 1800uF (NIPPON CHEMI-CON) x3 parallel
 - +36V : LXZ 50V 1000uF (NIPPON CHEMI-CON) x3 parallel
 - +48V : LXZ 63V 820uF (NIPPON CHEMI-CON) x3 parallel
 - +60V : LXV 100V 270uF (NIPPON CHEMI-CON) x 3 parallel
 - b) Remote sensing function is used.
 Connect "+S" terminal to "+" terminal of the electrolytic capacitor and "-S" terminal to "-" terminal of the electrolytic capacitor with sensing wires.
- 4) Pay attention to above items before using the unit. Incorrect usage could lead to unstable output voltage.

HWS1800T/HD Specifications(Read instruction manual carefully, before using the power supply unit.)

ITEMS/UNITS		MODEL	HWS1800T -3/HD	HWS1800T -5/HD	HWS1800T -6/HD	HWS1800T -7/HD	HWS1800T -12/HD	HWS1800T -15/HD	HWS1800T -24/HD	HWS1800T -36/HD	HWS1800T -48/HD	HWS1800T -60/HD		
Input	Voltage Range (*2)	V	3φ AC170 - 265											
	Frequency (*2)	Hz	47-63											
	Power Factor (200VAC)(typ) (*1)		0.94											
	Efficiency (200VAC)(typ) (*1)	%	75	81	82	84	88	90						
	Current (200VAC)(typ) (*1)	A	4.5	6.0						7.0				
	Inrush Current (200VAC)(typ) (*3)	A	40											
Output	Leakage Current(240VAC) (*10)	mA	2.6 max											
	Nominal Voltage	VDC	3.3	5	6	7.5	12	15	24	36	48	60		
	Maximum Current	A	300		250	200	125	100	75	50	37.5	30		
	Maximum Peak Current (*12)	A	-		300	240	150	120	105	70	52.5	42		
	Maximum Power	W	990	1500						1800				
	Maximum Peak Power (*12)	W	-		1800				2520					
	Maximum Line Regulation (*5)	mV	36			40	48	60	96	144	192	240		
	Maximum Load Regulation (*6)	mV	60						72	90	144	216	288	360
	Temperature Coefficient		Less than 0.02%/°C											
	Ripple & Noise (*4)	+25 to +71°C	mVp-p	150			200			250		300		400
			0°C	200			250			300		400		
		-10°C	mVp-p	220			250			300		400		600
			ms	20						18				
Hold-up Time (typ) (*9)														
Voltage Adjustable Range	VDC	2.64-3.96	4.0-6.0	4.8-7.2	6.0-9.0	9.6-14.4	12.0-18.0	19.2-28.8	28.8-43.2	38.4-52.8	48.0-66.0			
Function	Over Current Protection (*7)	A	>315.0		>303.0	>242.4	>151.5	>121.2	>106.0	>70.7	>53.0	>42.4		
	Over Voltage Protection (*8)	VDC	4.12-4.62	6.25-7.0	7.5-8.4	9.37-10.5	15.0-17.4	18.7-21.8	30.0-34.8	45.0-49.7	55.2-60.0	69.0-75.0		
	Remote Sensing		Possible											
	Remote ON/OFF Control		Possible											
	Parallel Operation		Possible											
	Series Operation		Possible											
	Monitoring Signal		PF(Open collector output)											
	Line DIP		Built to meet SEMI-F47											
	Other Function		PCB Coating on solder side and component side.											
	Environment	Operating Temperature (*11)	°C	-10 to +71, Guarantee Start up -40 to -10										
-10 to +40°C			W	990	1500						1800			
+50°C			W	825	1250	1500				1680				
+60°C			W	660	1000	1125				1300				
+71°C			W	495	750						900			
Storage Temperature		°C	-40 to +85											
Operating Humidity		%RH	10 - 90 (No Condensing)											
Storage Humidity		%RH	10 - 95 (No Condensing)											
Mechanical	Vibration (*13)(*14)		At no operating, 10 - 55Hz (Sweep for 1min.) 19.6m/s² Constant, X,Y,Z 1hour each. Designed to meet MIL-STD-810F 514.5 Category 4 figure 514.5C-1, Category 10											
	Shock (In package) (*14)		Less than 196.1m/s² Designed to meet MIL-STD-810F 516.5 Procedure I											
	Cooling		Forced Air By Blower Fan											
Isolation	Withstand Voltage		Input - FG : 2kVAC (20mA), Input - Output : 3kVAC (20mA) Output-FG : 500VAC (300mA), (60V model 651VAC(390mA)), Output-CNT:100VAC (100mA) for 1min.											
	Isolation Resistance		More than 100MΩ Output - FG : 500VDC More than 10MΩ Output - CNT : 100VDC at 25°C and 70%RH											
Standards	Safety Standards		Approved by UL60950-1, CSA C22.2 No.60950-1, EN60950-1											
	EMI Immunity		Built to meet EN55011/EN55022-A, FCC-ClassA, VCCI-ClassA											
Mechanical	Weight (typ)	g	4000					3800						
	Size (W×H×D)	mm	126.5 x 82 x 280 (Refer to Outline Drawing)											

(*1) At Ta=25°C and maximum output power.

(*2) For cases where conformance to various safety specs (UL, CSA, EN) are required, input voltage range will be 200 - 240VAC(50/60Hz).

(*3) First in-rush current. Not applicable to the first 0.2ms in-rush current flowing into the power supply noise filter.

(*4) Measure with JEITA RC-9131A probe, Bandwidth of scope :100MHz. (at 100uF electric capacitor and 0.47uF film capacitor on the test fixture board.)
Ripple noise spec for ambient temperature between -10 to 25 is a linearity value with respect to the -10 degrees C and 25 degrees C specs.

(*5) 170 - 265VAC , constant load.

(*6) No load-Full load, constant input voltage.

(*7) Constant current limit with automatic recovery. Over current condition for more than 5 seconds will cause the output to shutdown. Output current exceeding maximum rated output current for more than 10 seconds continuously will result to output shutdown.

(*8) OVP circuit will shut down output, manual reset (Power cycle) or ON/OFF CNT signal reset.

(*9) At 200VAC(50/60Hz), nominal output voltage and maximum output current.

(*10) Measured by the each measuring method of UL, CSA and EN (at 60Hz), Ta=25°C.

(*11) Ratings - Derating at standard mounting.

- As for other mountings, refer to derating curve.

- For conditions of start up at -40°C~-10°C, refer to derating curve.

(*12) Peak output current is less than 10 seconds, and duty 35% max.

(*13) Category 4 exposure levels : Truck transportation over U.S. highways.

(*14) It is compulsory to fix BRACKET onto product for MIL-STD-810F 516.5 Procedure I and MIL-STD-810F 514.5 category 10 compliance.

● Recommended EMC Filter



RSEN-2030

Please refer to "TDK-Lambda EMC Filters" catalog.

Please refer to page a_HWS_24 for MIL-STD Mounting

Outline Drawing

[HWS1800T/HD]

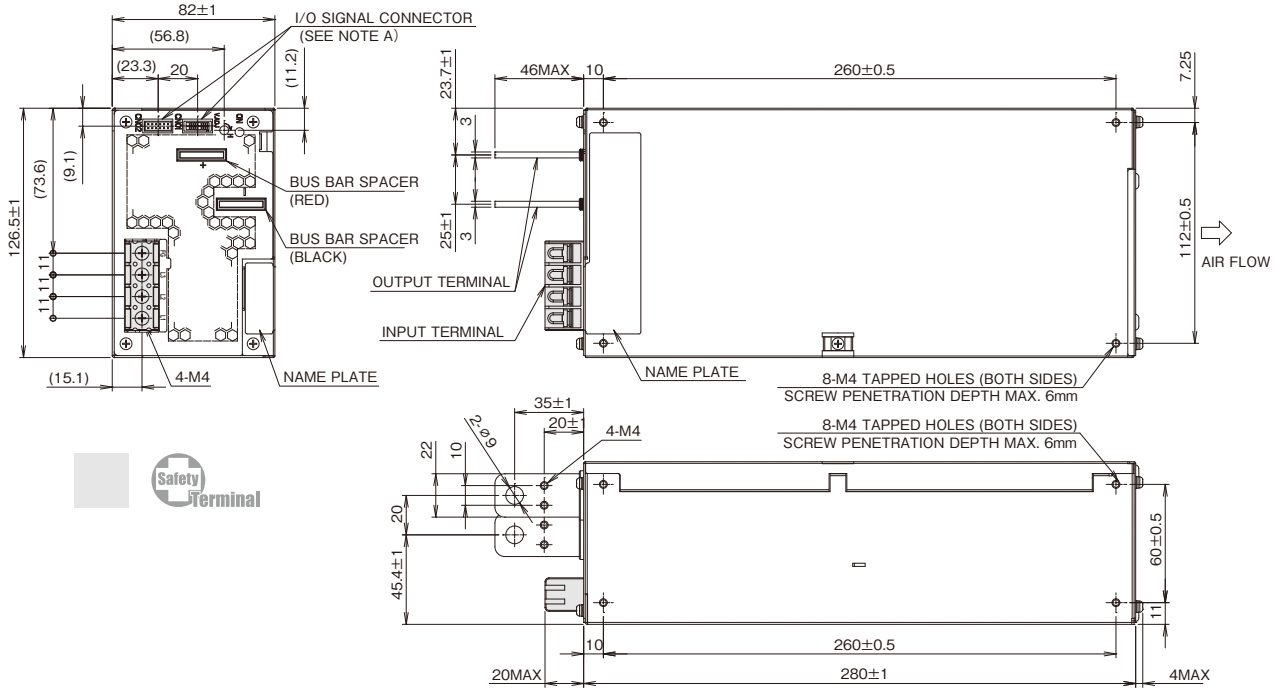

NOTES

- A: I/O SIGNAL CONNECTOR
 CONNECTOR : S12B-PHDSS(LF)(SN) (JST)
 MATCHING HOUSING : PHDR-12VS (JST)
 MATCHING CONTACT : SPHD-002T-P0.5(AWG28~24) (JST) OR
 SPHD-001T-P0.5(AWG26~22) (JST) OR
 BPHD-001T-P0.5(AWG26~22) (JST)
 HAND CRIMPING TOOL : YRS-620(SPHD-002T-P0.5) (JST)
 YC-610R(SPHD-001T-P0.5) (JST)
 YC-610R(BPHD-001T-P0.5) (JST)

ACCESSORIES

- * ATTACHED CONNECTOR (3~7V)
 SHORTING +S~(+), -S~(-), PV~REF & CNT~TOG
 ATTACHED ON CN01 AT SHIPMENT
- * ATTACHED CONNECTOR (12~60V)
 SHORTING +S~+V, -S~V, PV~REF & CNT~TOG
 ATTACHED ON CN01 AT SHIPMENT
- * A separate connector not included is required in order to utilize the power supply function.

[unit: mm]
 [Chassis material:SPCC-SD]

Output Derating

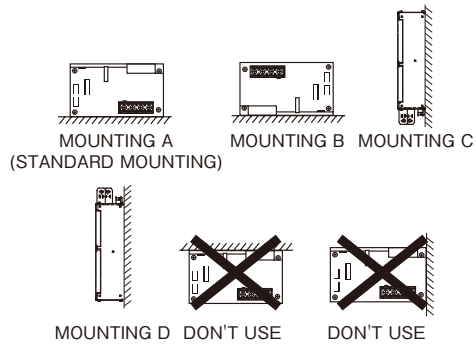
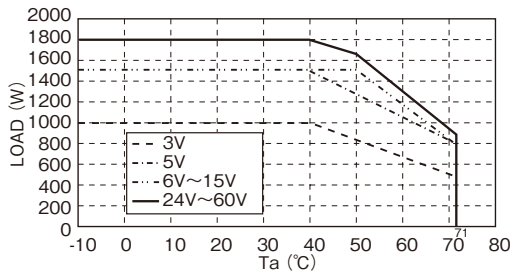

Start-up condition at low temperature

● DERATING TO START UP AT Ta : -40 to -10° C

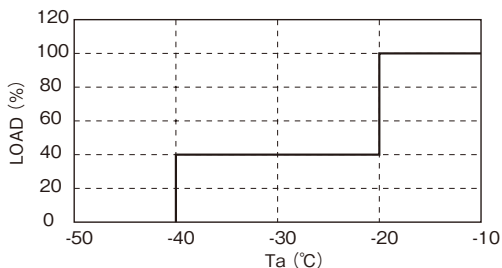

=NOTES=

- 1) Input voltage: Not gradual start up.
- 2) No Condensing.
- 3) Output voltage becomes more stable by performing the following.
 - a) Electrolytic capacitor is added to an output.
 - +3.3V,+5V,+6V : LXZ 10V 5600uF (NIPPON CHEMI-CON) x 3 parallel
 - +7.5V : LXZ 16V 3900uF (NIPPON CHEMI-CON) x 3 parallel
 - +12V : LXZ 25V 2700uF (NIPPON CHEMI-CON) x3 parallel
 - +15V : LXZ 25V 2700uF (NIPPON CHEMI-CON) x3 parallel
 - +24V : LXZ 35V 1800uF (NIPPON CHEMI-CON) x3 parallel
 - +36V : LXZ 50V 1000uF (NIPPON CHEMI-CON) x3 parallel
 - +48V : LXZ 63V 820uF (NIPPON CHEMI-CON) x3 parallel
 - +60V : LXV 100V 270uF (NIPPON CHEMI-CON) x 3 parallel
 - b) Remote sensing function is used.
 Connect "+S" terminal to "+" terminal of the electrolytic capacitor and "-S" terminal to "-" terminal of the electrolytic capacitor with sensing wires.
- 4) Pay attention to above items before using the unit. Incorrect usage could lead to unstable output voltage.

POWER SUPPLY MOUNTING FOR MIL-STD

When MIL vibration(MIL-STD-810F 514.5 Category 4 figure 514.5C-1, Category 10) & MIL shock(MIL-STD-810F 516.5 Procedure I) specification is necessary, mount the power supply using the specification or equivalent. Please prepare the bracket of the specification reference.

Screw must not penetrate into power supply by more than 6mm.

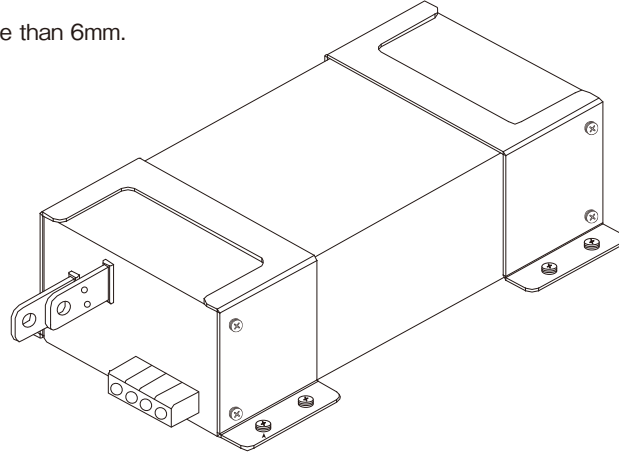

Specification Reference

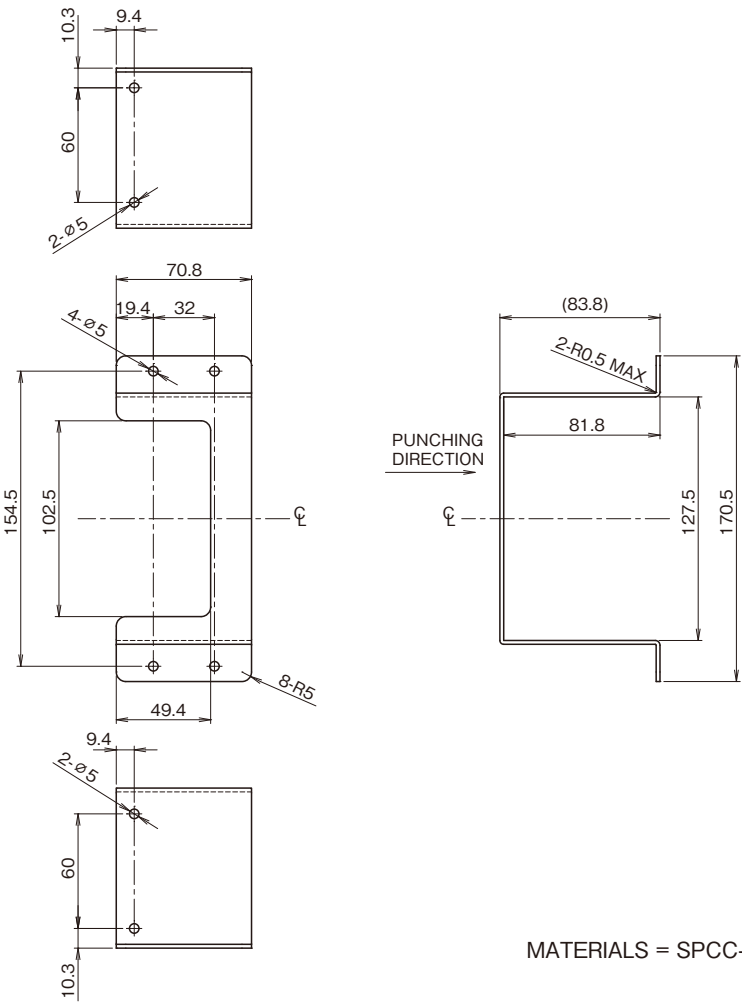
Model	Outline / Mounting method(mm)
HWS1000/HD HWS1500/HD HWS1800T/HD	 <p style="text-align: right;">MATERIALS = SPCC-SD (t=2.0)</p>

HWS/ME

Single Output 300W-1500W



■ Features

- AC-DC switching power supply for medical equipment.
 - Approval UL60601-1 (*1)
 - Approval EN60601-1 (*1)
 - Approval CSA C22.2 No.601.1-M90 (*1)
- Environmentally-friendly:
 - High-efficiency technology reduces power loss by heat generation. Fan stopping in power-off by external control reduces acoustic noise and saves energy.
- Easy to use: All models in the same height of 82mm. Mountable in 2U-height racks without dead space.
- Safety and reliability: “Safety terminal” covering current flowing part secures safety for users. “No screw-dropping” design prevents from losing screws during maintenance operation.

■ Model naming method

[HWS300-1500]
HWS 300 – 5 / ME
 Series name Output power

ME: With cover and forced air cooling by built-in fan, approved safety standards for medical equipment

Nominal output voltage
 ex. 3: 3.3V, 5: 5V, 48: 48V

■ Applications



MED

■ Conformity to RoHS Directive

This means that, in conformity with EU Directive 2002/95/EC, lead, cadmium, mercury, hexavalent chromium, and specific bromine-based flame retardants, PBB and PBDE, have not been used, except for exempted applications.

■ Product Line up

Output Voltage	300W		600W		1000W		1500W	
	Output Current	Model	Output Current (Peak)	Model	Output Current (Peak)	Model	Output Current ^(*) (Peak)	Model
5V	—	—	120A	HWS600-5/ME	—	—	—	—
12V	27A	HWS300-12/ME	53A	HWS600-12/ME	—	—	—	—
15V	22A	HWS300-15/ME	43A	HWS600-15/ME	—	—	—	—
24V	14A (16.5A)	HWS300-24/ME	27A (31A)	HWS600-24/ME	46A (58.5A)	HWS1000-24/ME	65A/70A (105A)	HWS1500-24/ME
36V	—	—	—	—	30.7A/ (39A)	HWS1000-36/ME	42A/46.5A (70A)	HWS1500-36/ME
48V	7A	HWS300-48/ME	13A	HWS600-48/ME	23A/ (29.2A)	HWS1000-48/ME	32A/32A	HWS1500-48/ME

(*) (100Vin/200Vin)

(*1) The following conditions are required.

- Please use the insulating material for the equipment chassis when the power supply is used in the equipment near patients.
- Approved with the basic insulation, an additional insulation circuit is required outside of the power supply.

HWS300/ME Specifications

(Read instruction manual carefully, before using the power supply unit.)

ITEMS/UNITS		MODEL	HWS300-12/ME	HWS300-15/ME	HWS300-24/ME	HWS300-48/ME	
Input	Voltage Range (*3)	V	AC85 - 265 or DC120 - 330				
	Frequency (*3)	Hz	47 - 63				
	Power Factor (100/200VAC)(typ) (*2)		0.99 / 0.95				
	Efficiency (100/200VAC)(typ) (*2)		80 / 83		82 / 85		
	Current (100/200VAC)(typ) (*2)	A	4.1 / 2.1				
	Inrush Current (100/200VAC)(typ) (*4)	A	20 / 40				
	Leakage Current (*11)	mA	Less than 0.5. (0.15 (typ) at 100VAC / 0.39 (typ) at 230VAC)				
Output	Nominal Voltage	VDC	12	15	24	48	
	Maximum Current (*1)	A	27	22	14 (16.5)	7	
	Maximum Power	W	324	330	336		
	Maximum Line Regulation (*6)	mV	48	60	96	192	
	Maximum Load Regulation (*7)	mV	72	90	144	288	
	Temperature Coefficient		Less than 0.02% /				
	Maximum Ripple & Noise (0≤Ta≤70) (*5)	mVp-p	150			350	
	Maximum Ripple & Noise (-10≤Ta<0) (*5)	mVp-p	200			400	
	Hold-up Time (typ) (*10)	ms	20				
	Voltage Adjustable Range	VDC	9.6 - 14.4	12.0 - 18.0	19.2 - 28.8	38.4 - 52.8	
Function	Over Current Protection (*8)	A	>28.4	>23.1	>16.7	>7.4	
	Over Voltage Protection (*9)	VDC	15.0 - 17.4	18.8 - 21.8	30.0 - 34.8	55.2 - 64.8	
	Remote Sensing		Possible				
	Remote ON/OFF Control		Possible				
	Parallel Operation		Possible				
	Series Operation		Possible				
	Monitoring Signal		PF (Open collector output)				
	Line DIP		Designed to meet SEMI-F47 (200VAC Line only)				
	Environment	Operating Temperature (*12)		-10 to +70 (-10 to +50: 100%, +70: 50%)			
		Storage Temperature		-30 to +85			
Operating Humidity		RH	10 to 90 (No dewdrop)				
Storage Humidity		RH	10 to 95 (No dewdrop)				
Vibration			At no operating, 10 - 55Hz (sweep for 1min) 19.6m/s ² constant, X, Y, Z 1hour each.				
Shock (In package)			Less than 196.1m/s ²				
Cooling			Forced air by blower fan				
Isolation	Withstand Voltage		Input - FG : 2.5kVAC (20mA), Input - Output : 3kVAC (20mA) Output - FG: 500VAC (100mA), Output-CNT: 100VAC(100mA) for 1min				
	Isolation Resistance		More than 100MΩ Output - FG : 500VDC More than 10MΩ Output -CNT : 100VDC at 25 and 70%RH				
Standards	Safety Standards (*13)		Approved by UL60601-1, EN60601-1, CSA-C22.2 No601.1-M90				
	PFHC		Designed to meet IEC61000-3-2				
	Voltage Fluctuations / Flicker Emissions		Designed to meet IEC61000-3-3				
	EMI		Designed to meet EN55011/EN55022-B, FCC-B, VCCI-B				
Mechanical	Immunity		Designed to meet IEC61000-4-2(Level 3), -3(Level 3), -4(Level 3), -5(Level 3,4), -6(Level 3), -8(Level 4), -11				
	Weight (typ)	g	1000				
	Size (W x H x D)	mm	61 x 82 x 165 (Refer to outline drawing)				

(*1) ():Peak output current at 200VAC. Operating time at peak output is less than 10 sec, duty is less than 35%.

(*2) At 100/200VAC, Ta=25 and maximum output power.

(*3) For cases where conformance to various safety specs (UL, EN, CSA) are required, to be described as 100 - 240VAC (50/60Hz).

(*4) Not applicable for the inrush current to noise filter for less than 0.2ms.

(*5) Measure with JEITA RC-9131A probe, bandwidth of scope: 100MHz.

(*6) 85 - 265VAC, constant load.

(*7) No load-full load, constant input voltage.

(*8) Constant current limit with automatic recovery.
Avoid to operate at over load or short circuit condition for more than 30 seconds.

(*9) OVP circuit will shut the output down, manual reset (CNT reset or re power on).

(*10) At 100/200VAC, nominal output voltage and maximum output current.

(*11) Measured by the each measuring method of UL, EN, and CSA (at 60Hz), Ta=25.
When using it as a patient care equipment, all outer surfaces of the equipment shall be constructed of nonconductive material. See clause 19.5DV.2 of UL60601-1.

(*12) Ratings - Derating at standard mounting. Refer to output derating curve.
- Load (%) is percent of maximum output power or maximum output current, whichever is greater.

(*13) As for UL60601-1, EN60601-1 and CSA-C22.2No601.1-M90, basic insulation.

Recommended EMC Filter



RSEN-2006L

Please refer to "TDK-Lambda EMC Filters" catalog.

Outline Drawing

[HWS300/ME]

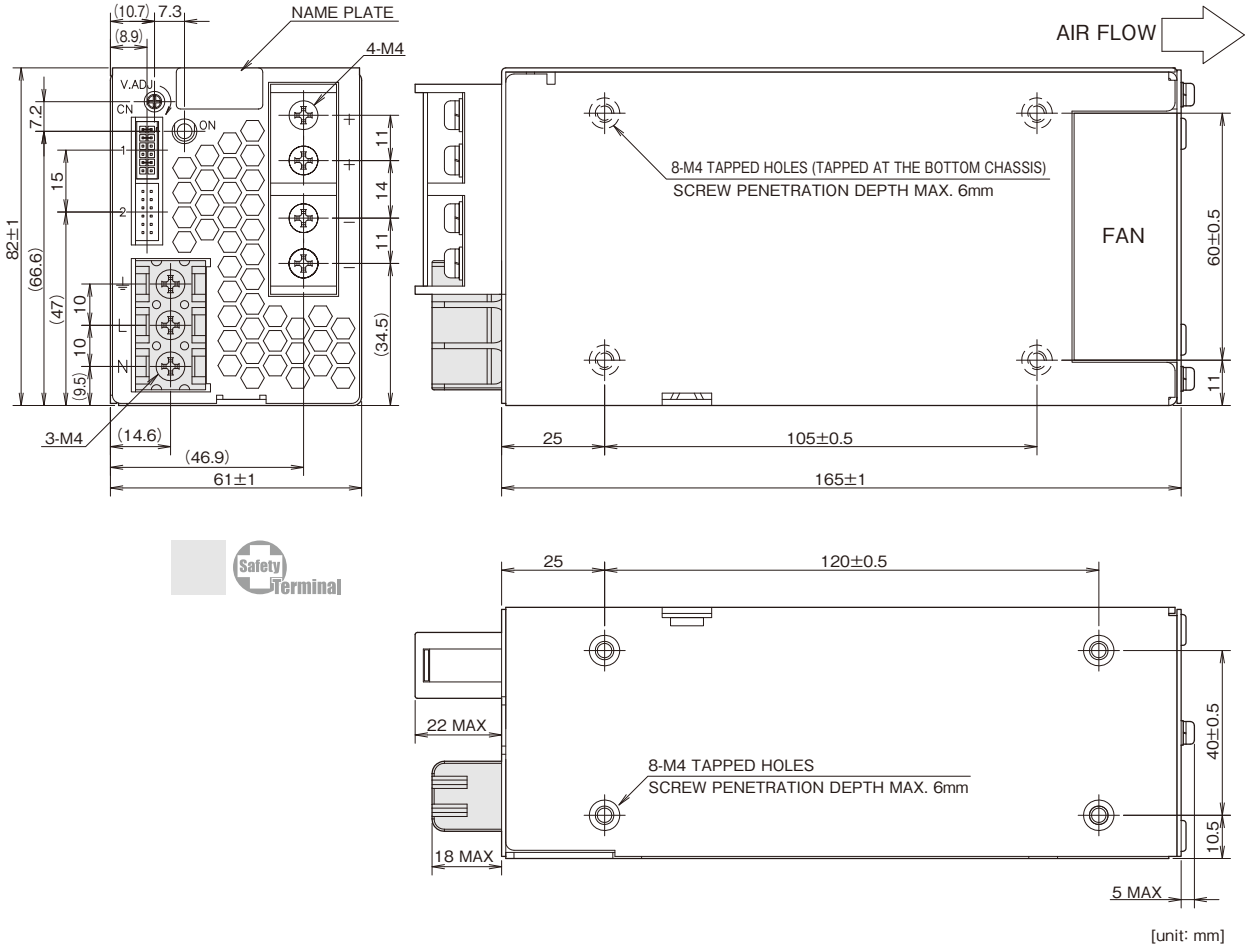

== SIGNAL CONNECTOR USED ==

PART DESCRIPTION	PART NAME	MANUFACT
PIN HEADER	S12B-PHDSS	JST

== MATCHING HOUSINGS, PINS & TOOL ==

PART DESCRIPTION	PART NAME	MANUFACT
SOCKET HOUSING	PHDR-12VS	JST
TERMINAL PINS	SPHD-002T-P0.5(AWG28~24) SPHD-001T-P0.5(AWG26~22)	JST
HAND CRIMPING TOOL	YRS-620(SPHD-002T-P0.5) YC-610R(SPHD-001T-P0.5)	JST

== ACCESSORIES ==

- *COVER FOR BARRIER TERMINAL STRIP -----1 (ATTACHED ON TERMINAL AT SHIPMENT)
- *SHORT PIECE -----1 SHORTING +Vm--+S, -Vm--S, CNT--TOG (ATTACHED ON CN1 AT SHIPMENT)

Output Derating

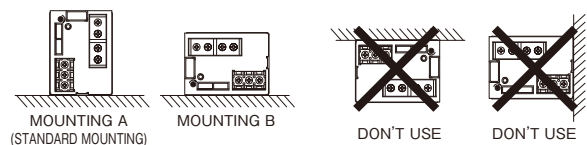
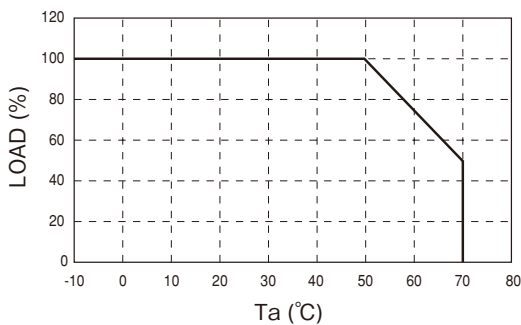

HWS600/ME Specifications

(Read instruction manual carefully, before using the power supply unit.)

ITEMS/UNITS		MODEL	HWS600-5/ME	HWS600-12/ME	HWS600-15/ME	HWS600-24/ME	HWS600-48/ME	
Input	Voltage Range (*3)	V	AC85 - 265 or DC120 - 330					
	Frequency (*3)	Hz	47 - 63					
	Power Factor (100/200VAC)(typ) (*2)		0.99 / 0.95					
	Efficiency (100/200VAC)(typ) (*2)	%	80/83		81/84	82/85	83/86	
	Current (100/200VAC)(typ) (*2)	A	7.5/3.6	8.1 / 3.9				
	Inrush Current (100/200VAC)(typ)	A	20 / 40					
	Leakage Current (*11)	mA	Less than 0.5. (0.12 (typ) at 100VAC / 0.34 (typ) at 230VAC)					
Output	Nominal Voltage	VDC	5	12	15	24	48	
	Maximum Current (*1)	A	120	53	43	27 (31)	13	
	Maximum Power	W	600	636	645	648	624	
	Maximum Line Regulation (*6)	mV	20	48	60	96	192	
	Maximum Load Regulation (*7)	mV	30	72	90	144	288	
	Temperature Coefficient (%)		Less than 0.02% / ° C					
	Maximum Ripple & Noise (0sTa≤70° C) (*5)	mVp-p	120	150		350		
	Maximum Ripple & Noise (-10sTa< 0° C) (*5)	mVp-p	180	200		400		
	Hold-up Time (typ) (*10)	ms	20					
	Voltage Adjustable Range	VDC	4.0 - 6.0	9.6 - 14.4	12.0 - 18.0	19.2 - 28.8	38.4 - 52.8	
Function	Over Current Protection (*8)	A	>126	>55.7	>45.2	>31.4	>13.7	
	Over Voltage Protection (*9)	VDC	6.25 - 7.25	15.0 - 17.4	18.8 - 21.8	30.0 - 34.8	55.2 - 64.8	
	Remote Sensing		Possible					
	Remote ON/OFF Control		Possible					
	Parallel Operation		Possible					
	Series Operation		Possible					
	Monitoring Signal		PF (Open collector output)					
	Line DIP		Designed to meet SEMI-F47 (200VAC Line only)					
	Environment	Operating Temperature (*12)	°C	-10 to +70 (-10 - +50: 100%, +70: 50%)				
		Storage Temperature	°C	-30 to +85				
Operating Humidity		%RH	10 - 90 (No dewdrop)					
Storage Humidity		%RH	10 - 95 (No dewdrop)					
Vibration			At no operating, 10 - 55Hz (sweep for 1min) 19.6m/s ² constant, X,Y,Z 1hour each.					
Shock (In package)			Less than 196.1m/s ²					
Cooling			Forced air by blower fan					
Isolation	Withstand Voltage		Input - FG : 2.5kVAC (20mA), Input - Output : 3kVAC (20mA) Output - FG : 500VAC (100mA), Output - CNT : 100VAC (100mA) for 1min					
	Isolation Resistance		More than 100MΩ Output - FG : 500VDC More than 10MΩ Output - CNT : 100VDC at 25° C and 70%RH					
Standards	Safety Standards (*13)		Approved by UL60601-1, EN60601-1, CSA-C22.2 No601.1-M90					
	PFHC		Designed to meet IEC61000-3-2					
	Voltage Fluctuations / Flicker Emissions		Designed to meet IEC61000-3-3					
	EMI		Designed to meet EN55011/EN55022-A, FCC-A, VCCI-A					
Mechanical	Immunity		Designed to meet IEC61000-4-2(Level 3), -3(Level 3), -4(Level 3), -5(Level 3,4), -6(Level 3), -8(Level 4), -11					
	Weight (typ)	g	1600					
	Size (W x H x D)	mm	100 x 82 x 165 (Refer to outline drawing)					

(*1) (): Peak output current at 200VAC. Operating time at peak output is less than 10 sec, duty is less than 35%.

(*2) At 100/200VAC, Ta=25° C and maximum output power.

(*3) For cases where conformance to various safety specs (UL, CSA, EN) are required, to be described as 100 - 240VAC (50/60Hz).

(*4) Not applicable for the inrush current to noise filter for less than 0.2ms.
Inrush current is 30A (typ) when PFHC start-up.

(*5) Measure with JEITA RC-9131A probe, bandwidth of scope: 100MHz.

(*6) 85 - 265VAC, constant load.

(*7) No load - full load, constant input voltage.

(*8) Constant current limit with automatic recovery.
Avoid to operate at over load or short circuit condition for more than 30 seconds.

(*9) OVP circuit will shut the output down, manual reset (CNT reset or re-power on).

(*10) At 100/200VAC, nominal output voltage and maximum output current.

(*11) Measured by the each measuring method of UL, EN, and CSA (at 60Hz), Ta=25° C.
When using it as a patient care equipment, all outer surfaces of the equipment shall be constructed of nonconductive material. See clause 19.5DV.2 of UL60601-1.

(*12) Ratings - Derating at standard mounting. Refer to output derating curve.
- Load (%) is percent of maximum output power or maximum output current, whichever is greater.

(*13) As for UL60601-1, EN60601-1 and CSA-C22.2 No601.1-M90, basic insulation.

● Recommended EMC Filter



RSEN-2006L

Please refer to "TDK-Lambda EMC Filters" catalog.

Outline Drawing

[HWS600/ME]

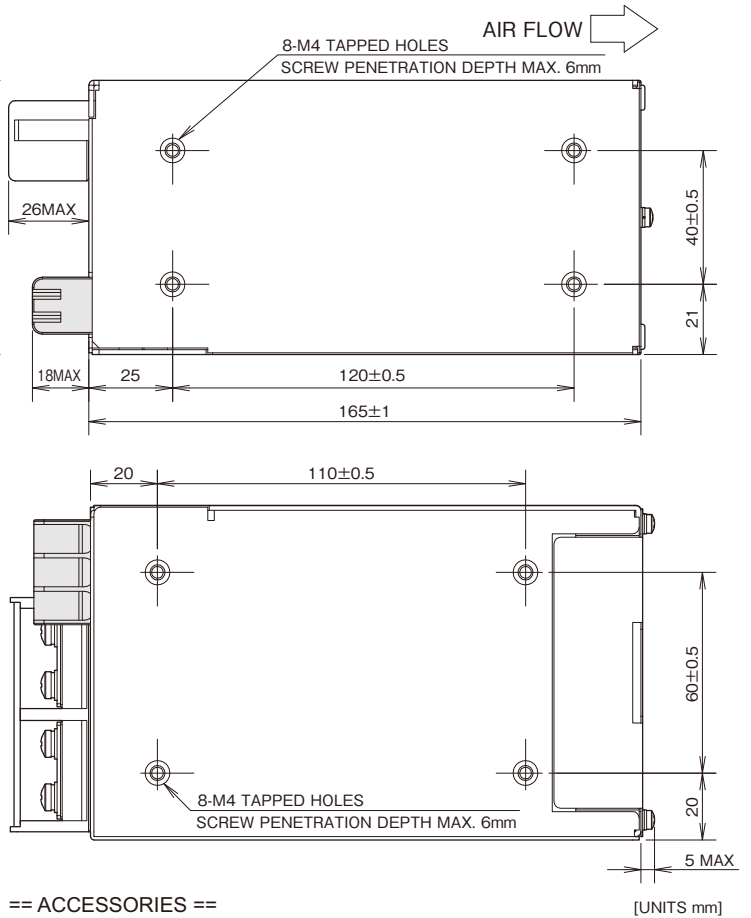
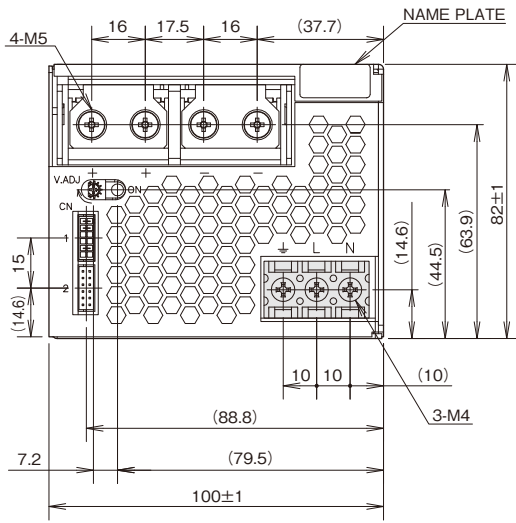

[UNITS mm]

== SIGNAL CONNECTOR USED ==

PART DESCRIPTION	PART NAME	MANUFACT
PIN HEADER	S12B-PHDSS	JST

== MATCHING HOUSINGS , PINS & TOOL ==

PART DESCRIPTION	PART NAME	MANUFACT
SOCKET HOUSING	PHDR-12VS	JST
TERMINAL PINS	SPHD-002T-P0.5(AWG28~24) SPHD-001T-P0.5(AWG26~22)	JST
HAND CRIMPING TOOL	YRS-620(SPHD-002T-P0.5) YC-610R(SPHD-001T-P0.5)	JST

== ACCESSORIES ==

- *COVER FOR BARRIER TERMINAL STRIP -----1
(ATTACHED ON TERMINAL AT SHIPMENT)
- *SHORT PIECE -----1
SHORTING +Vm--+S, -Vm--S, CNT--TOG
(ATTACHED ON CN1 AT SHIPMENT)

Output Derating

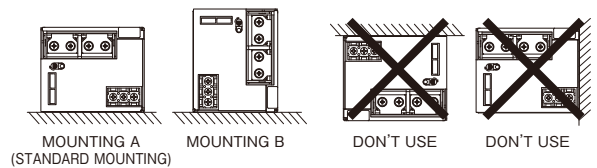
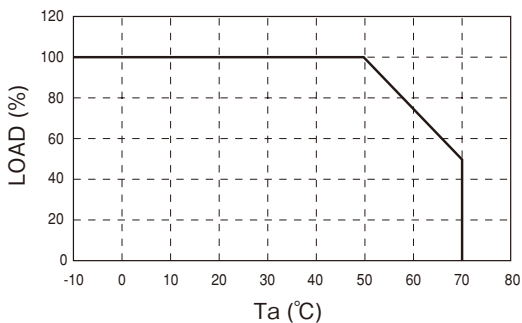

HWS1000/ME Specifications

(Read instruction manual carefully, before using the power supply unit.)

ITEMS/UNITS		MODEL	HWS1000-24/ME	HWS1000-36/ME	HWS1000-48/ME
Input	Voltage Range (*2)	V	AC85 - 265 or DC120 - 330		
	Frequency (*2)	Hz	47 - 63		
	Power Factor (100/200VAC)(typ) (*1)		0.98/0.95		
	Efficiency (100/200VAC)(typ) (*1)		85/87	85/88	86/88
	Current (100/200VAC)(typ) (*1)	A	13.5/7.0		
	Inrush Current (100/200VAC)(typ) (*3)	A	20/40		
Leakage Current (*10)	mA	Less than 0.5 (0.2(Typ) at 100VAC / 0.4(typ) at 230VAC)			
Output	Nominal Voltage	VDC	24	36	48
	Maximum Current	A	46	30.7	23
	Maximum Peak Current (*13)	A	58.5	39	29.2
	Maximum Power	W	1104		
	Maximum Peak Power (*13)	W	1404		
	Maximum Line Regulation (*5)	mV	96	144	192
	Maximum Load Regulation (*6)	mV	150		
	Temperature Coefficient		Less than 0.02%/		
	Maximum	0 to +71 mVp-p	150	200	
	Ripple & Noise (*4)	-10 to 0 mVp-p	180	240	500
	Hold-up Time (typ) (*9)	ms	20		
Voltage Adjustable Range	VDC	19.2-28.8	28.8-43.2	38.4-52.8	
Over Current Protection (*7)	A	>61.4	>40.9	>30.6	
Over Voltage Protection (*8)	VDC	30.0-34.8	45.0-49.7	55.2-60.0	
Function	Remote Sensing		Possible		
	Remote ON/OFF Control		Possible		
	Parallel Operation		Possible		
	Series Operation		Possible		
	Monitoring Signal		PF(Open collector output)		
	Line DIP		Built to meet SEMI-F47 (200VAC Line only)		
Environment	Operating Temperature (*11)		-10 to +71, Start up -20 to +71		
		-10 to +40°C	100		
		+50°C	100		
		+71°C	50		
	Storage Temperature		-30 to +85		
	Operating Humidity	RH	10 - 90 (No Condensing)		
	Storage Humidity	RH	10 - 95 (No Condensing)		
Vibration		At no operating, 10 - 55Hz (Sweep for 1min.) 19.6m/s ² Constant, X,Y,Z 1hour each.			
Shock (In package)		Less than 196.1m/s ²			
Cooling		Forced Air By Blower Fan			
Isolation	Withstand Voltage		Input - FG : 2kVAC (20mA), Input - Output : 3kVAC (20mA) Output-FG : 500VAC (300mA), Output-CNT:100VAC (100mA) for 1min.		
	Isolation Resistance		More than 100MΩ Output - FG : 500VDC More than 10MΩ Output - CNT : 100VDC at 25 and 70%RH		
Standards	Safety Standards (*12)		Approved by UL60601-1, EN60601-1,CSA C22.2 No.601.1-M90(C-UL)		
	PFHC		Built to meet IEC61000-3-2		
	Voltage Fluctuations/Flicker Emissions		Built to meet IEC61000-3-3		
	EMI		Built to meet EN55011/EN55022-A, FCC-ClassA, VCCI-ClassA, CISPR-ClassA.		
Mechanical	Immunity		Built to meet IEC61000-4-2(Level 2,3), -3(Level 3), -4(Level 3), -5(Level 3,4), -6(Level 3), -8(Level 4), -11		
	Weight (max)	g	3200		
	Size (W×H×D)	mm	126.5 x 82 x 240 (Refer to Outline Drawing)		

(*1) At Ta=25 and maximum output power.

(*2) For cases where conformance to various safety specs (UL, CSA, EN) are required, input voltage range will be 100 - 240VAC(50/60Hz).

(*3) First in-rush current. Not applicable to the first 0.2ms in-rush current flowing into the power supply noise filter.

(*4) Measure with JEITA RC-9131A probe, Bandwidth of scope : 100MHz. (at 100uF electric capacitor and 0.47uF film capacitor on the test fixture board.)

(*5) 85 - 265VAC , constant load.

(*6) No load-Full load, constant input voltage.

(*7) Constant current limit with automatic recovery. Over current condition for more than 5 seconds will cause the output to shutdown.
Output current exceeding maximum rated output current for more than 10 seconds continuously will result to output shutdown.

(*8) OVP circuit will shut down output, manual reset (Power cycle) or ON/OFF CNT signal reset.

(*9) At 100/200VAC, nominal output voltage and maximum output current.

(*10) Measured by the each measuring method of UL, CSA, EN and DENAN (at 60Hz), Ta=25 .
When using it as a patient care equipment, all outer surfaces of the equipment shall be constructed of nonconductive material. See clause 19.5DV.2 of UL60601-1.

(*11) Ratings - Derating at standard mounting.
- Load (%) is percent of maximum output power or maximum output current, whichever is greater.
- As for other mountings, refer to derating curve.

(*12) As for UL60601-1, EN60601-1 and CSA-C22.2 No.601.1-M90(C-UL) basic insulation.

(*13) Peak output current is less than 10 seconds, and duty 35% max. (200VAC Line only)

Recommended EMC Filter



RSEN-2006L
Please refer to "TDK-Lambda EMC Filters" catalog.

Outline Drawing

[HWS1000/ME]

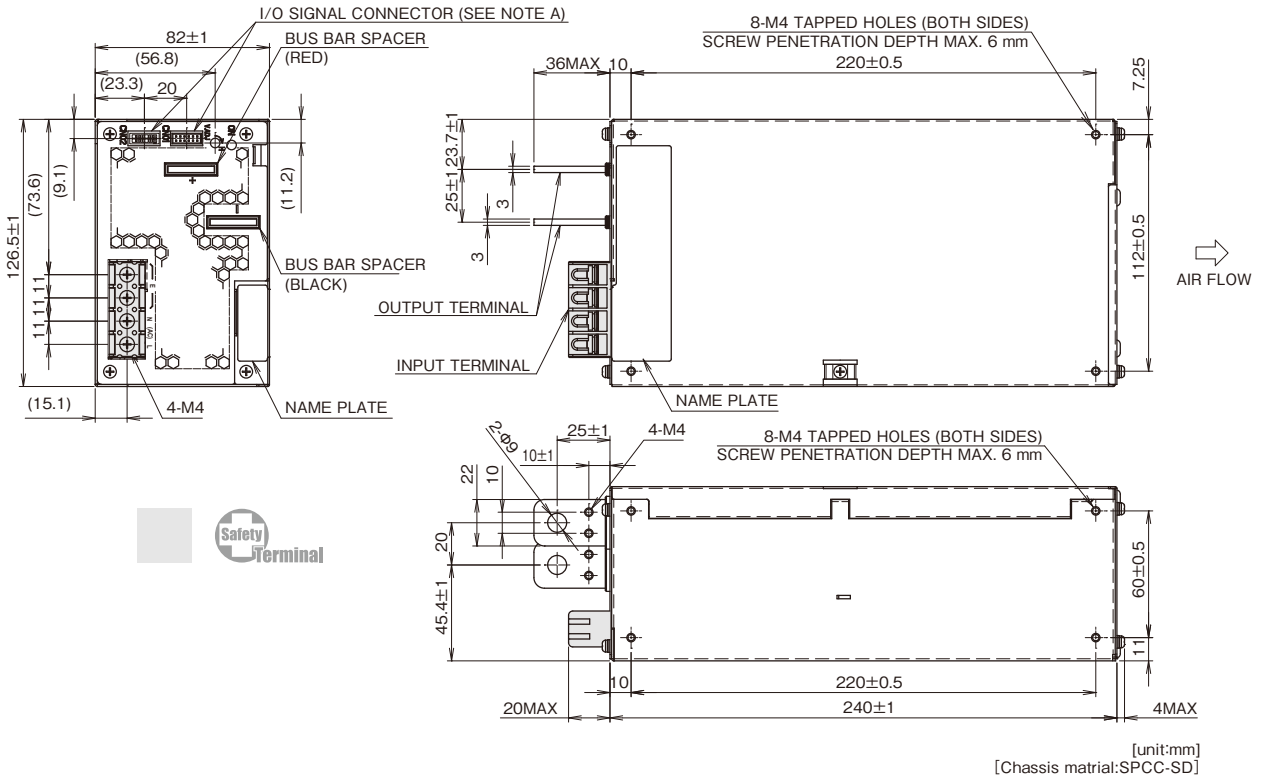

NOTES

- A : I/O SIGNAL CONNECTOR
- | | | |
|--------------------|------------------------------|----------|
| CONNECTOR | : S12B-PHDSS(LF)(SN) | (JST) |
| MATCHING HOUSING | : PHDR-12VS | (JST) |
| MATCHING CONTACT | : SPHD-002T-P0.5(AWG28 ~ 24) | (JST) OR |
| | : SPHD-001T-P0.5(AWG26 ~ 22) | (JST) OR |
| | : BPHD-001T-P0.5(AWG26 ~ 22) | (JST) |
| HAND CRIMPING TOOL | : YRS-620(SPHD-002T-P0.5) | (JST) |
| | : YC-610R(SPHD-001T-P0.5) | (JST) |
| | : YC-610R(BPHD-001T-P0.5) | (JST) |

ACCESSORIES

- * ATTACHED CONNECTOR SHORTING +S ~ +V, -S ~ -V, PV ~ REF & CNT ~ TDG ATTACHED ON CN02 AT SHIPMENT
- * A separate connector not included is required in order to utilize the power supply function.

Output Derating

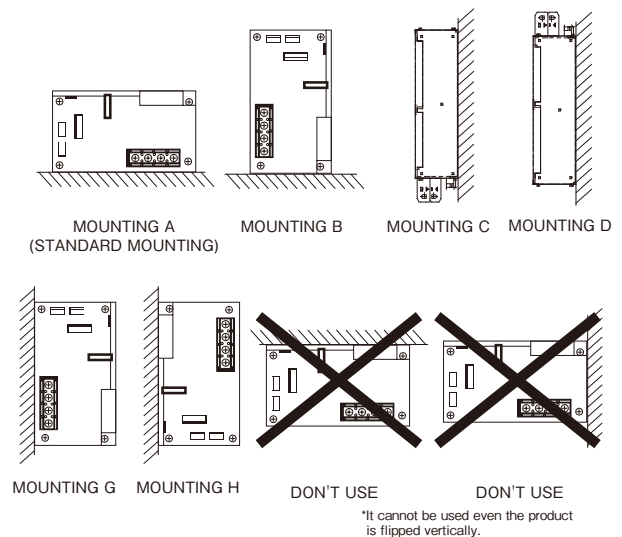
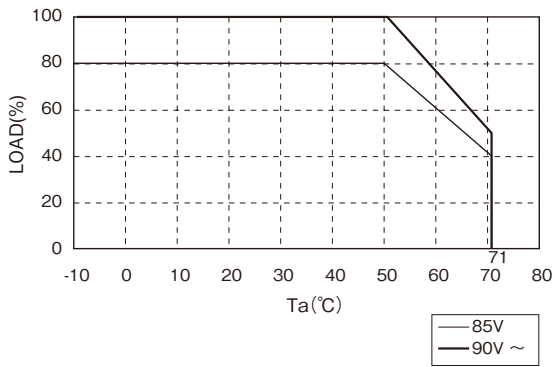

HWS
 HWS HD
 HWS ME
 HWS-P
 Instruction Manual

HWS1500/ME Specifications

(Read instruction manual carefully, before using the power supply unit.)

ITEMS/UNITS		MODEL	HWS1500-24/ME	HWS1500-36/ME	HWS1500-48/ME
Input	Voltage Range (*2)	V	AC85 - 265		
	Frequency (*2)	Hz	47 - 63		
	Power Factor (100/230VAC)(typ) (*1)		0.98 / 0.94		
	Efficiency (100/200VAC)(typ) (*1)	%	84 / 88		86 / 90
	Current (100/200VAC)(typ) (*1)	A	19.0 / 10.0		
	Inrush Current (100/200VAC)(typ)(*3)	A	20 / 40		
	Leakage Current (*10)	mA	Less than 0.5. (0.2 (typ) at 100VAC / 0.4 (typ) at 230VAC)		
Output	Nominal Voltage	VDC	24	36	48
	Maximum Current (100/200VAC)	A	65 / 70	42 / 46.5	32 / 32
	Maximum Peak Current (*13)	A	105	70	-
	Maximum Power (100/200VAC)	W	1560 / 1680	1512 / 1674	1536 / 1536
	Maximum Peak Power (*13)	W	2520		
	Maximum Line Regulation (*5)	mV	96	144	192
	Maximum Load Regulation (*6)	mV	144	150	288
	Temperature Coefficient		Less than 0.02%/		
	Maximum Ripple & Noise (*4)	0 to +70 mVp-p	200		
		-10 to 0 mVp-p	240		
	Hold-up Time (typ) (*9)	ms	20		
	Voltage Adjustable Range	VDC	19.2 - 28.8	28.8 - 43.2	38.4 - 52.8
	Function	Over Current Protection (*7)	A	>110.2	>73.5
Over Voltage Protection (*8)		VDC	30.0 - 34.8	45.0-49.7	55.2 - 64.8
Remote Sensing			Possible		
Remote ON/OFF Control			Possible		
Parallel Operation			Possible		
Series Operation			Possible		
Monitoring Signal			PF (Open collector output)		
Line DIP			Built to meet SEMI-F47 (200VAC Line only)		
Operating Temperature (*11)			-10 to +70 (-10 to +50: 100%, +60: 75%, +70: 50%), start up -20 to 70		
Storage Temperature			-30 to +85		
Environment	Operating Humidity	%RH	10 - 90 (No Condensing)		
	Storage Humidity	%RH	10 - 95 (No Condensing)		
	Vibration		At no operating, 10 - 55Hz (sweep for 1min.) 19.6m/s ² constant, X, Y, Z 1hour each.		
	Shock (In package)		Less than 196.1m/s ²		
	Cooling		Forced air by blower fan		
Isolation	Withstand Voltage		Input - FG : 2kVAC (20mA), Input - Output : 3kVAC (20mA) Output-FG : 500VAC (300mA), Output-CNT:100VAC (100mA) for 1min.		
	Isolation Resistance		More than 100MΩ Output - FG : 500VDC More than 10MΩ Output - CNT : 100VDC at 25 and 70%RH		
Standards	Safety Standards (*12)		Approved by UL60601-1, EN60601-1, CSA C22.2 No.601.1-M90 (C-UL)		
	PFHC		Built to meet IEC61000-3-2		
	Voltage Fluctuations / Flicker Emissions		Built to meet IEC61000-3-3		
	EMI		Approved by EN55011 / EN55022-A, FCC-Class A, VCCI-Class A		
Mechanical	Weight (typ)	g	3800		
	Size (W x H x D)	mm	126.5 x 82 x 280 (Refer to outline drawing)		

(*1) At Ta=25 and maximum output power.

(*2) For cases where conformance to various safety specs (UL, CSA, EN) are required, input voltage range will be 100 - 240VAC (50/60Hz).

(*3) First in-rush current. Not applicable to the first 0.2ms in-rush current flowing into the power supply noise filter.

(*4) Measure with JEITA RC-9131A probe, Bandwidth of scope :100MHz. (at 100uF electric capacitor and 0.47uF film capacitor on the test fixture board.)

(*5) 85 - 265VAC, constant load.

(*6) No load-Full load, constant input voltage.

(*7) Constant current limit with automatic recovery. Over current condition for more than 5 seconds will cause the output to shutdown.
Output current exceeding maximum rated output current for more than 10 seconds continuously will result to output shutdown.

(*8) OVP circuit will shut down output, manual reset (Power cycle) or ON/OFF CNT signal reset.

(*9) At 100/200VAC, nominal output voltage and maximum output current.

(*10) Measured by the each measuring method of UL, EN and CSA (at 60Hz).

When using it as a patient care equipment, all outer surfaces of the equipment shall be constructed of nonconductive material. See clause 19.5DV.2 of UL60601-1.

(*11) Ratings - Derating at standard mounting.

- Load (%) is percent of maximum output power or maximum output current, whichever is greater.
- As for other mountings, refer to derating curve.

(*12) As for UL60601-1, EN60601-1 and CSA-C22.2 No.601.1-M90 (C-UL) basic insulation.

(*13) Peak output current is less than 10 seconds, and duty 35% max. (200VAC Line only)

Recommended EMC Filter



RSEN-2030L

Please refer to "TDK-Lambda EMC Filters" catalog.

Outline Drawing

[HWS1500/ME]

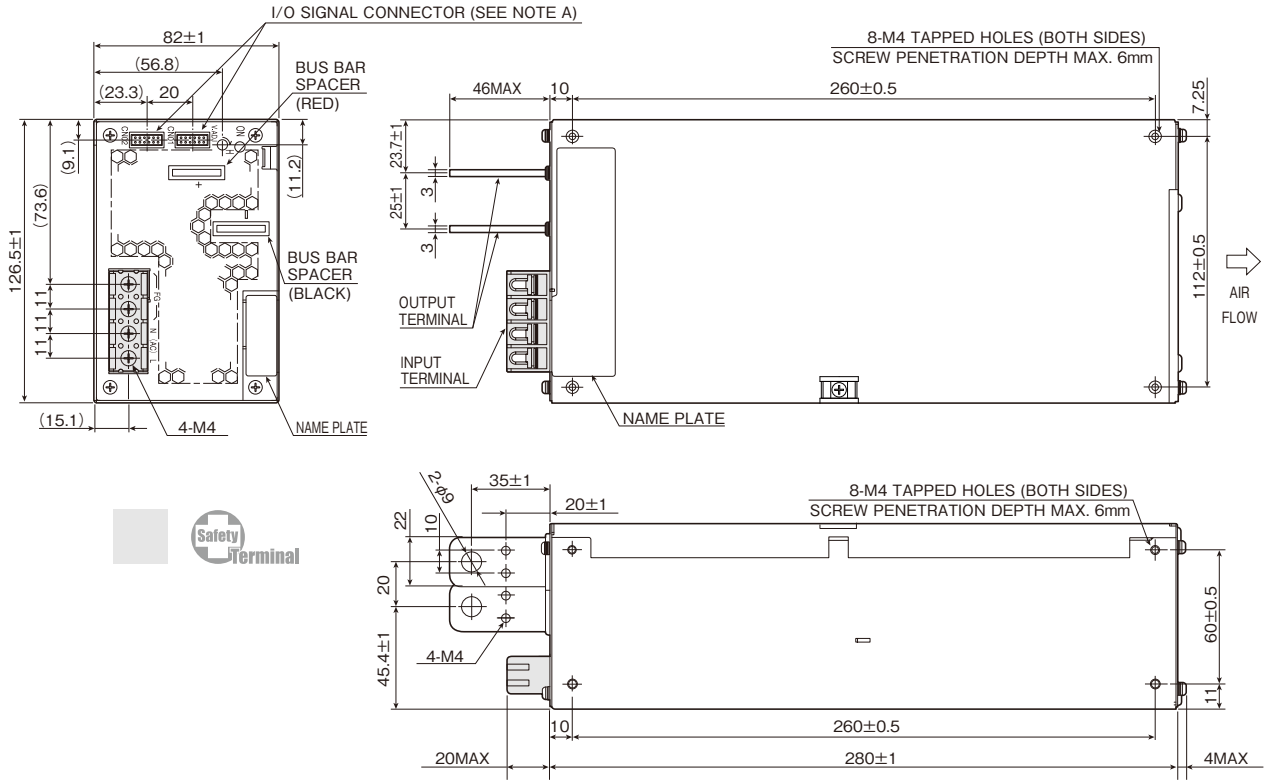

[unit:mm]
[Chassis matrial:SPCC-SD]

NOTES

A : I/O SIGNAL CONNECTOR

- CONNECTOR : S12B-PHDSS(LF)(SN) (JST)
- MATCHING HOUSING : PHDR-12VS (JST)
- MATCHING CONTACT : SPHD-002T-P0.5(AWG28 ~ 24) (JST) OR
SPHD-001T-P0.5(AWG26 ~ 22) (JST) OR
BPHD-001T-P0.5(AWG26 ~ 22) (JST)
- HAND CRIMPING TOOL : YRS-620(SPHD-002T-P0.5) (JST)
YC-610R(SPHD-001T-P0.5) (JST)
YC-610R(BPHD-001T-P0.5) (JST)

ACCESSORIES

- * ATTACHED CONNECTOR
SHORTING +S ~ +V, -S ~ -V, PV ~ REF & CNT ~ TDG
ATTACHED ON CN01 AT SHIPMENT
- * A separate connector not included is required in order to utilize the power supply function.

Output Derating

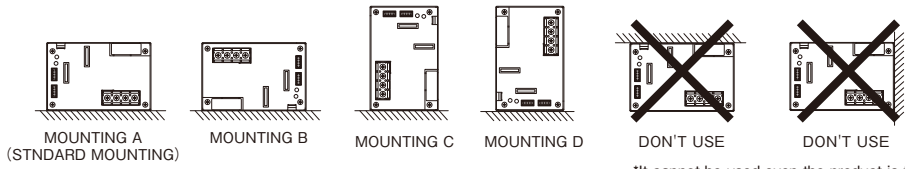
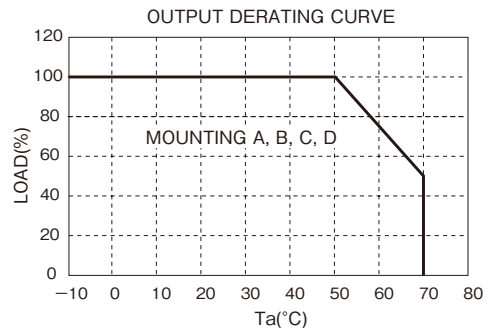
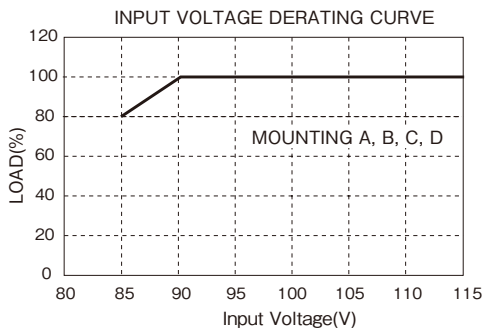

*It cannot be used even the product is flipped vertically.

TDK·Lambda

Block Diagram

[HWS300, HWS600]

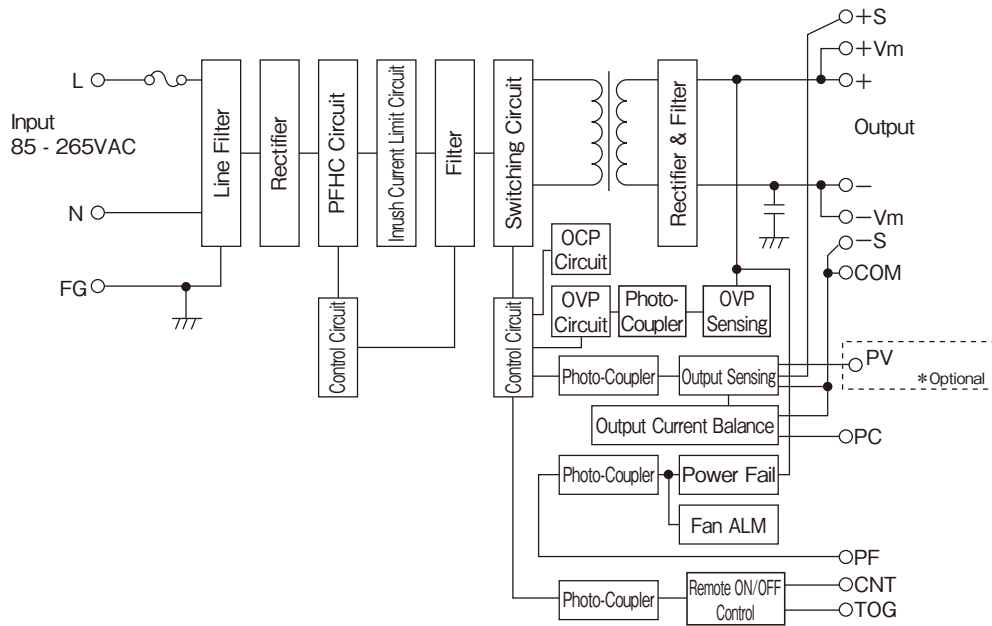

- Circuit topology, switching frequency
 Cascade forward topology 190kHz (fixed)
 PFHC circuit : active filter
 HWS300 : 80kHz (fixed) , HWS600 : 90kHz (fixed)

- Fuse rating :
 HWS300 : 10A, HWS600 : 15A

[HWS1000]

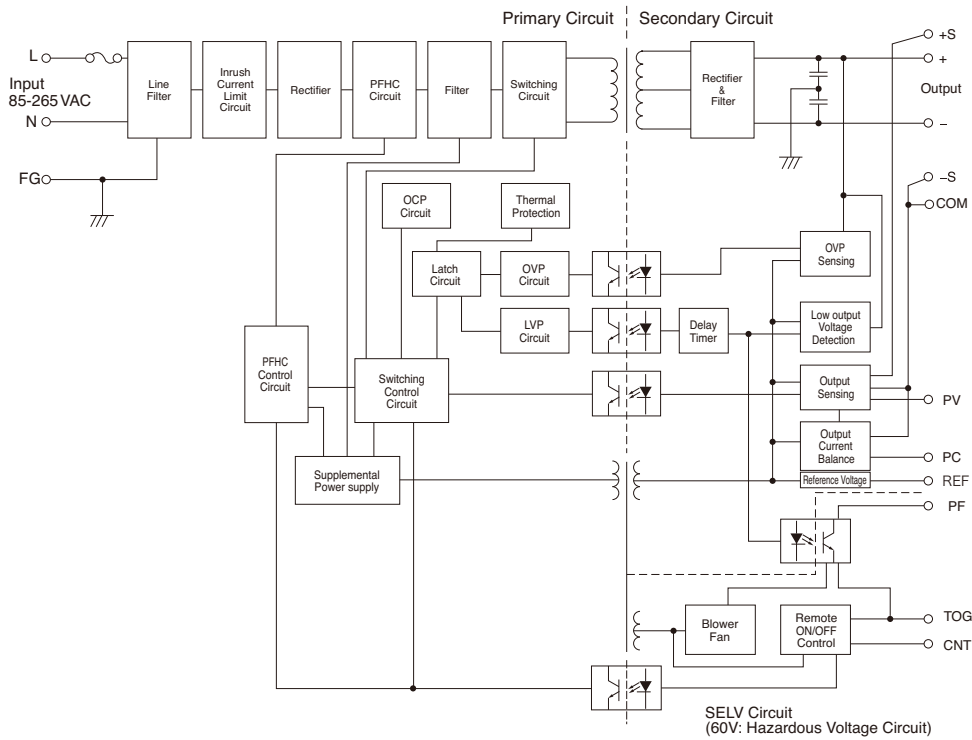

- SWITCHING CIRCUIT
 HALF-BRIDGE CONVERTER 46kHz (fixed)
- PFHC CIRCUIT ACTIVE FILTER 63kHz (fixed)
- FUSE RATING 20A
- FG FUNCTION GROUND

Block Diagram

[HWS1500]

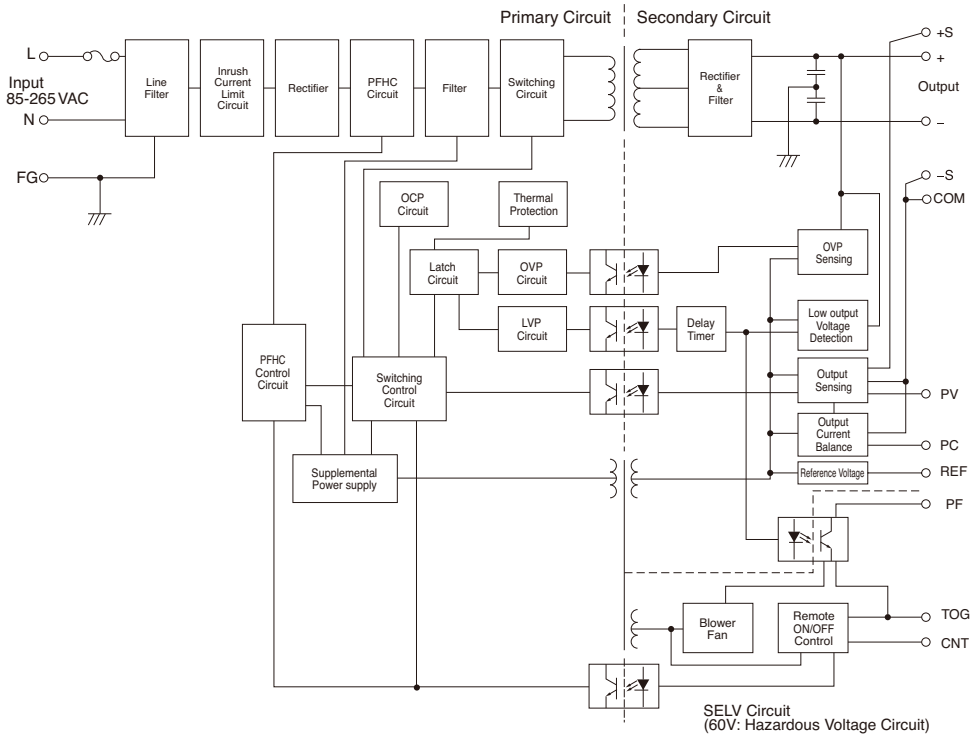

- Switching circuit
Half - bridge converter : 3 - 5V 45kHz (fixed), 6 - 7V 55kHz (fixed), 12 - 60V 70kHz (fixed)
- PFHC circuit : Active filter 65kHz (fixed)
- Fuse rating : 30A
- FG : Function ground

[HWS1800T]

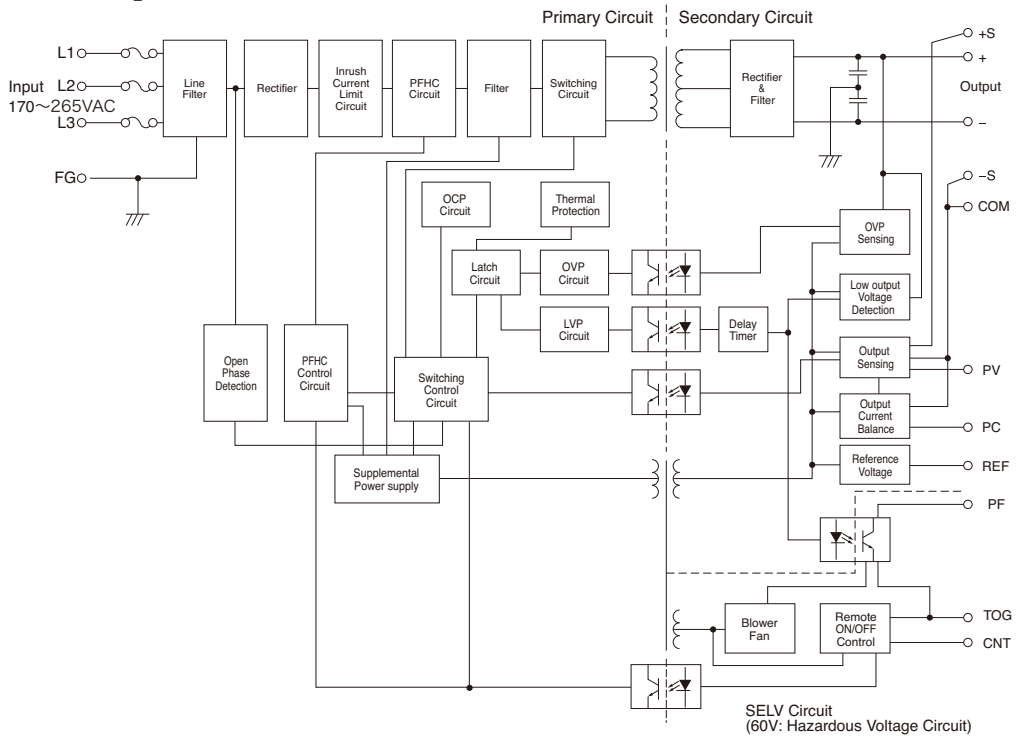

- Switching circuit
Half - bridge converter : 3 - 5V 45kHz (fixed), 6 - 7V 55kHz (fixed), 12 - 60V 70kHz (fixed)
- PFHC circuit : Active filter 65kHz (fixed)
- Fuse rating : 20A
- FG : FUNCTION GROUND

HWS

HWS HD

HWS ME

HWS-P

Instruction Manual

Sequence Time Chart

[HWS300, HWS600]

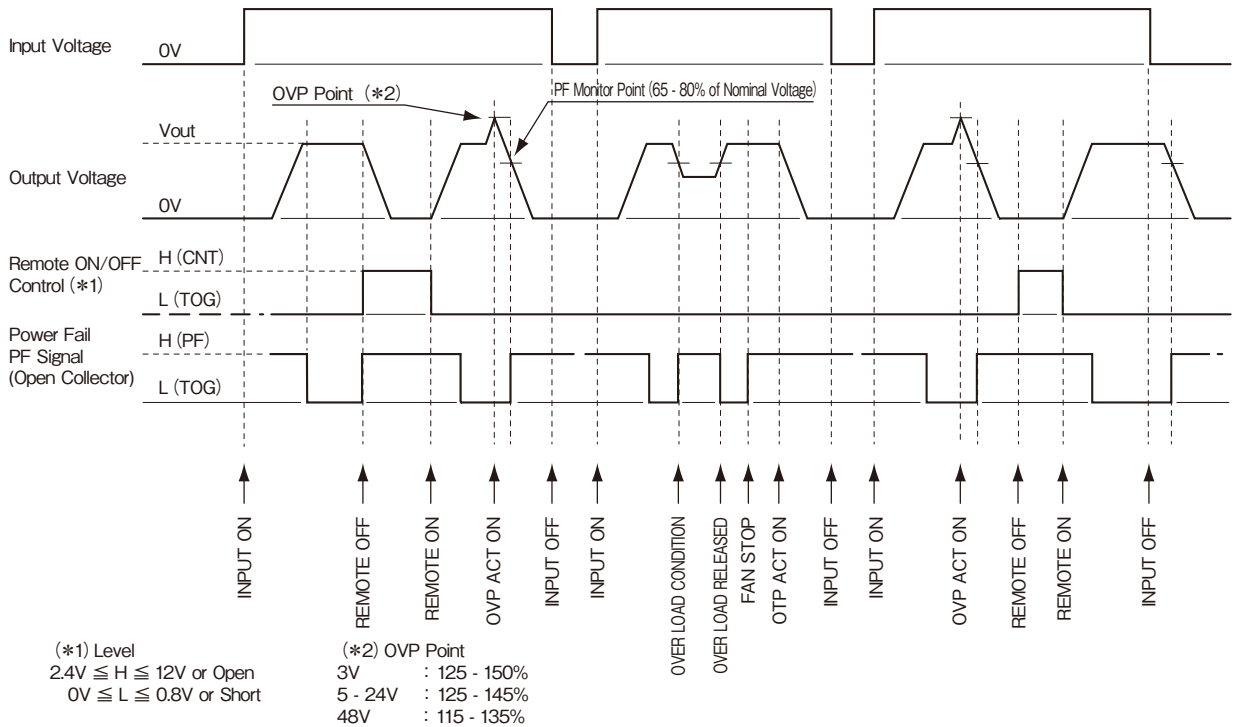

[HWS1000]

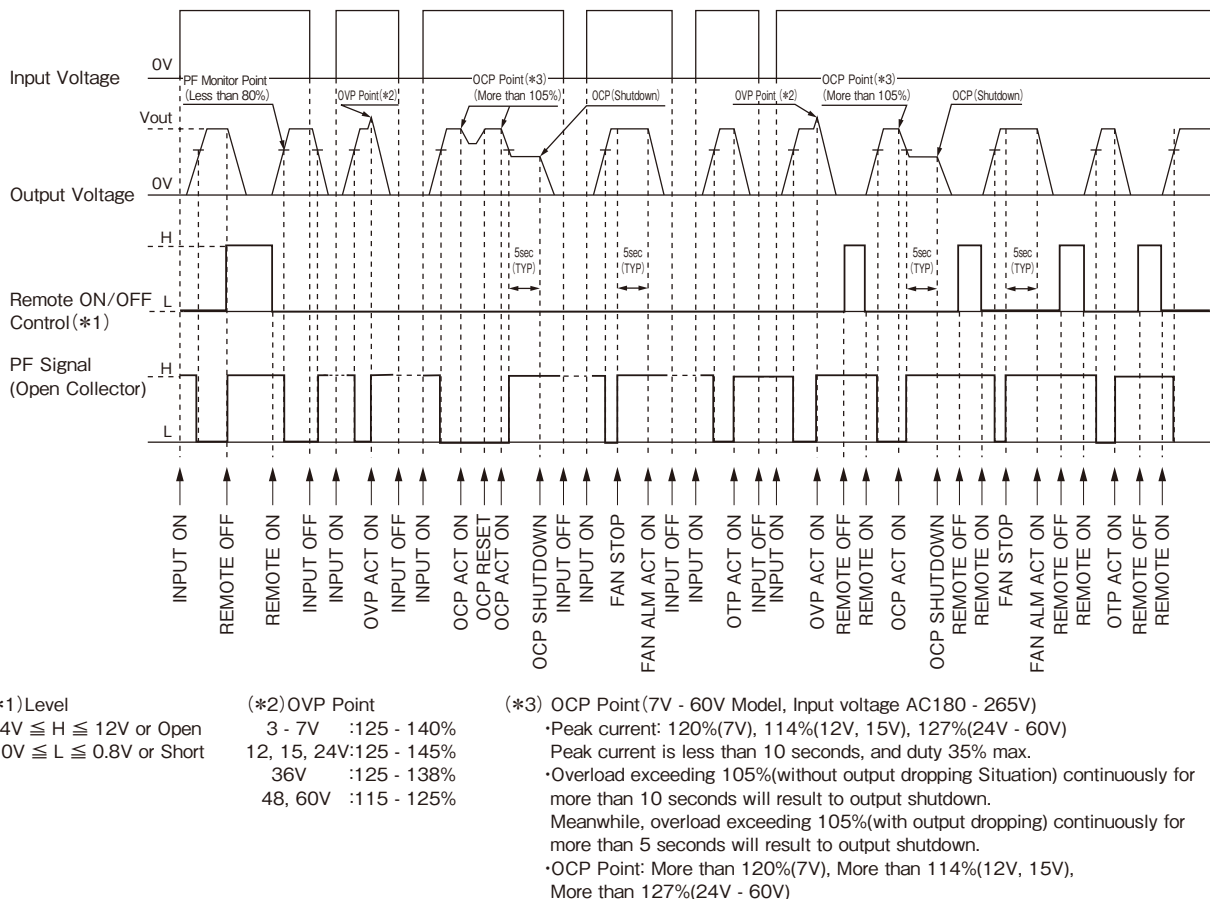

Sequence Time Chart

[HWS1500]

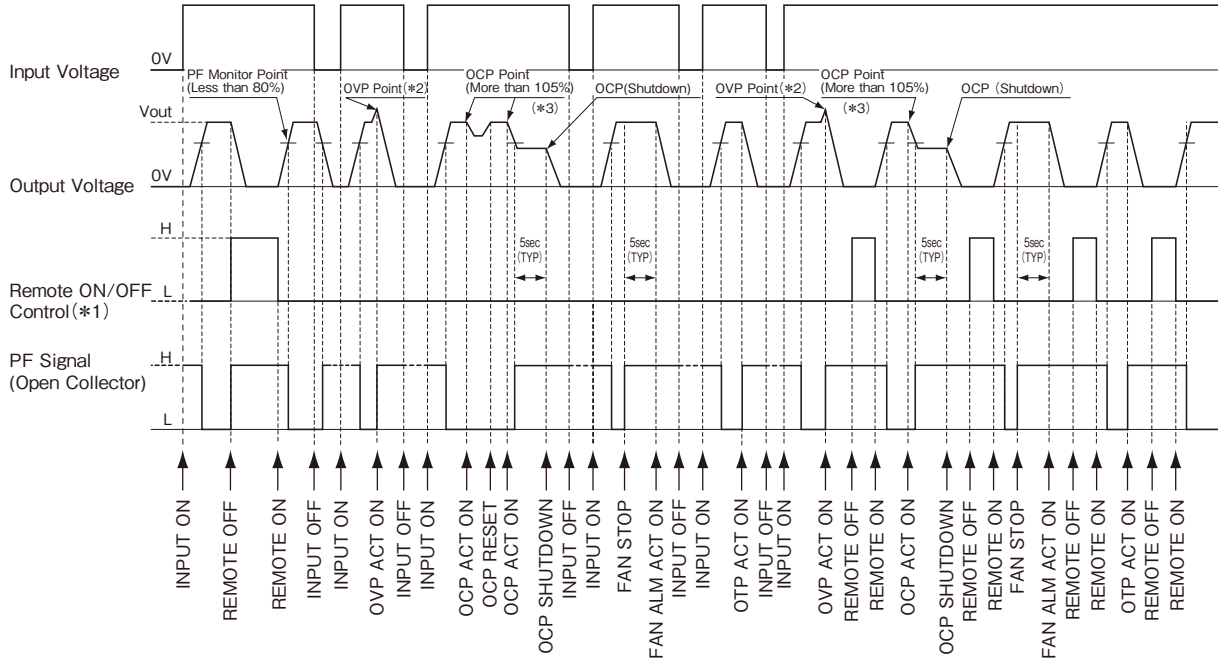

(*1) Level
 2.4V ≤ H ≤ 12V or Open
 0V ≤ L ≤ 0.8V or Short

(*2) OVP Point
 3 - 7V : 125 - 140%
 12, 15, 24V : 125 - 145%
 36V : 125 - 138%
 48V : 115 - 135%
 60V : 115 - 125%

(*3) OCP Point(6V 7V, 24V, 36V, 60V Model, Input voltage AC180 - 265V)
 •Peak current: 120%(6V 7V), 150%(24V, 36V, 60V)
 Peak current is less than 10 seconds, and duty 35% max.
 •Overload exceeding 105%(without output dropping situation) continuously for more than 10 seconds will result to output shutdown.
 •Meanwhile, overload exceeding 105%(with output dropping) continuously for more than 5 seconds will result to output shutdown.
 •OCP Point: More than 120%(6V 7V), More than 150%(24V, 36V, 60V)

[HWS1800T]

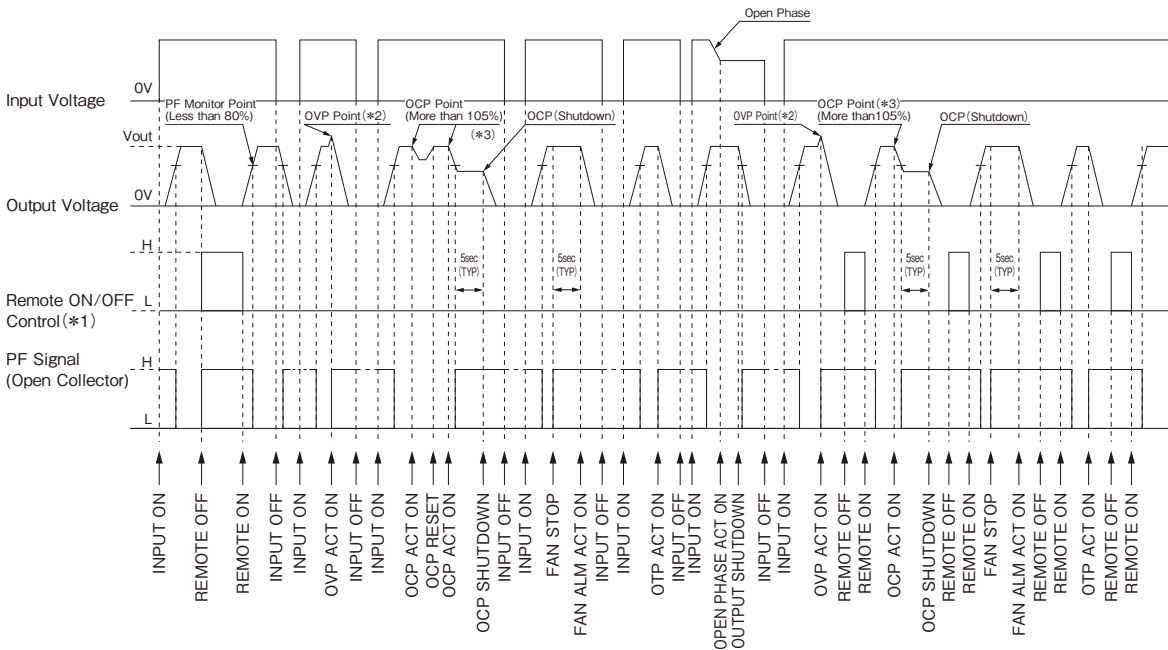

(*1) Level
 2.4V ≤ H ≤ 12V or Open
 0V ≤ L ≤ 0.8V or Short

(*2) OVP Point
 3 - 7V : 125 - 140%
 12, 15, 24V : 125 - 145%
 36V : 125 - 138%
 48, 60V : 115 - 125%

(*3) OCP Point
 •Peak current: 120%(6V - 15V), 140%(24V - 60V)
 Peak current is less than 10 seconds, and duty 35% max.
 •Overload exceeding 105%(without output dropping situation) continuously for more than 10 seconds will result to output shutdown.
 Meanwhile, overload exceeding 105%(with output dropping) continuously for more than 5 seconds will result to output shutdown.
 •OCP Point: More than 120%(6V - 15V), More than 140%(24V - 60V)

HWS300, 600 Series Instruction Manual

BEFORE USING THE POWER SUPPLY UNIT

Be sure to read the following precautions thoroughly before using this power supply unit.

Pay attention to all warnings and cautions before using the unit. Incorrect usage could lead to an electric shock, damage or a fire hazard.

WARNING

- Do not make unauthorized changes to power supply unit, otherwise you may have electric shock and void warranty.
- Do not touch the internal components, they may have high voltage or high temperature. You may get electric shock or burned.
- When the unit is operating, keep your hands and face away from it; an accident may injure you.
- Do not use unit under unusual condition such as emission of smoke or abnormal smell and sound etc. It might cause fire and electric shock.
In such case, please contact us; do not repair by yourself, as it is dangerous for the user.
- Do not drop or insert anything into unit. It might cause failure and fire, when using the unit under such condition.
- Do not operate these units at the condition of condensation. It may cause fire and electric shock.
- The outputs of these products must be earthed in the end use equipment to maintain SELV.
If the outputs are not earthed, they must be considered hazardous and must not be made user accessible.

CAUTION

- This power supply is primarily designed and manufactured to use and enclose in other equipment.
- This power supply unit has a built-in fan for air-cooling. Do not block air intake and exhaust. It might cause fire.
- Input voltage, output current, output power, ambient temperature and ambient humidity should be within specifications, otherwise the unit will be damaged.
- The unit might be broken down by accident or unexpected situation. For application equipment, which requires very high reliability (nuclear related equipment, traffic control equipment, medical equipment, etc.), please provide fail safety function in the equipment.

- Do not make an improper wiring to input and output terminals. It may cause damage.
- Do not use in environment such as strong electromagnetic field, erosive gas etc, or any environment where conductive foreign substance may enter.
- Do not operate and store this unit at the condition of condensation. In such case, waterproof treatment is necessary.
- Do not operate this unit after it falls down.
- The output voltage of this power supply is considered to be a hazardous energy level, and must not be accessible to an operator.

Notes for HWS30-150/ME IEC/EN/UL60601-1

NOTES

- The product should be completely enclosed in the application according to the specifications, and contact to the I/O part with the patient be limited. Be careful when designing the outline. Please refer to section 16, IEC/EN/UL60601-1.
- This product is not suitable for the use of the combustible narcotic that oxygen or the nitrous oxide mixed.
- The signal port connects only the device that suits IEC/EN/UL60601-1.
- It is necessary to fuse it in two poles of the main power supply in the overall equipment into which this product is built excluding the permanent installation type equipment defined by IEC/EN/UL60601-1 section 57.6. The fuse is installed in the monopole of the input of this product (live line).
- Between I/O of this product is evaluated as the basic insulation by IEC/EN/UL60601-1. Please add further insulation for safe contact to the output part.
- Please refer to local regulations for the disposal of the product that passes the life.
- The leakage current of this product in normal condition is 500uA or less. (At input voltage 230VAC.) The unit is suitable for medical equipment as provided by IEC/EN/UL60601-1. In the application according to the UL60601 requirement, it is assumed that surfaces of all equipment is assembled with the insulating materials.
- This product is not evaluated by IEC/EN/UL60601-1-2(EMC). However, EMC test data is available at TDK-Lambda.

1. Terminal Explanation

Please pay extra attention to the wiring. Incorrect connection will damage the power supply.

1 Front Panel Explanation

● HWS300

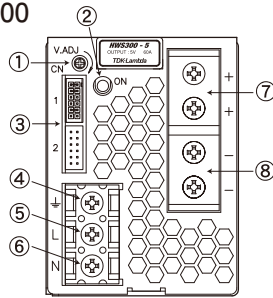

● HWS600

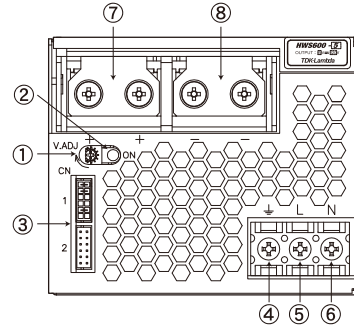

- ① V.ADJ: Output voltage adjustment trimmer. (The output voltage rises when a trimmer is turned clockwise.)
- ② ON: Output (Power On) indication LED (The indicator turns on when the power supply output is in normal operating condition.)
- ③ CN1, CN2: Remote sensing, ON/OFF control signal, Current balance signal, Power fail signal, Output voltage external control signal. (Refer to 2-2.)

- ④ ⊥ : Protective Earth (Frame ground), M4 screw.
- ⑤ AC input terminal L: Live Line (Fuse in line), M4 screw.
- ⑥ AC input terminal N: Neutral line, M4 screw.
- ⑦ +: + Output terminal (HWS300: M4 screw x 2 / HWS600: M5 screw x 2)
- ⑧ -: - Output terminal (HWS300: M4 screw x 2 / HWS600: M5 screw x 2)

2 CN1, CN2 Connector pin Configuration and Function

CN1 and CN2 are same pin configuration and function. They are connected to each other in this power supply unit. When the pin of CN1 side is shorted, the same function pins of CN2 side are also shorted. Please note that the function cannot be separately set with CN1 and CN2.

Pin No	Configuration	Function
1	+ Vm	+Output monitor terminal. Connected to +Output terminal in this Power supply unit. (+Vm terminal can not supply load current.)
2	+ S	Remote sensing terminal for +output. (For remote sensing function, which compensates for line drop between power supply terminals and load terminals. Connect to +Vm terminal when remote sensing function unnecessary.)
3	- Vm	-Output monitor terminal. Connected to -Output terminal in this Power supply unit. (-Vm terminal can not supply load current.)
4	- S	Remote sensing terminal for -output. (For remote sensing function, which compensates for line drop between power supply terminals and load terminals. Connect to -Vm terminal when remote sensing function unnecessary.)
5	PC	Current balance terminal. (For output current balancing in parallel operation.)
6	COM	GND for PC and PV signals.
7	PV (Optional)	Output voltage external control terminal. (For power supply output voltage control with an external voltage. Standard models don't have this function and indicate NC mark at panel.)
8	NC	No connect
9	CNT	Remote ON/OFF control terminal. (Power supply ON/OFF control with an external signal.)
10	TOG	GND for CNT and PF signals. (Same as Pin No.12)
11	PF	Power fail signal (PF signal) output terminal. (As the output voltage drops, or FAN stops and AC input voltage down, "Power Fail" terminal will output "High".
12	TOG	GND for CNT and PF signals. (Same as Pin No.10)

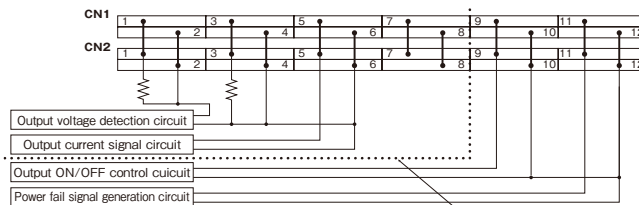
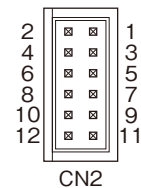
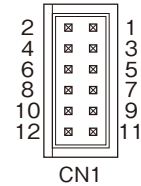

* Output ON/OFF control circuit and the power fail signal circuit are insulated with other circuits in the power supply (insulating voltage AC100V).

CN1, CN2 Connector & Housing & Terminal Pin

PART DESCRIPTION	PART NAME	MANUFACT
PIN HEADER	S12B-PHDSS	JST
SOCKET HOUSING	PHDR-12VS	JST
TERMINAL PINS	SPHD-002T-P0.5 (AWG28-24) SPHD-001T-P0.5 (AWG26-22)	JST
HAND CRIMPING TOOL	YRS-620 (SPHD-002T-P0.5) YC-610R (SPHD-001T-P0.5)	JST

2. Terminal Connection Method

Please pay extra attention to the wiring. Incorrect connection will damage the power supply.

- When connecting input and output wiring, and CN1, CN2, input AC-Line should be off.
- Input wiring and output wiring shall be separated to improve noise sensibility.
- The protective earth (PE) must be connected to the \perp terminal or chassis.

- Remote sensing lines shall be twisted or used with shielded wired.
- Remote ON/OFF control lines shall be twisted or used shielded wires. Separate from load line.
- Output current of each terminal screw shall be less than 40A for HWS300. And shall be less than 60A for HWS600.

HWS300 Panel Side (Common HWS600)

Basic connection (Local sensing)

Connect "+S" terminal to "+Vm" terminal and "-S" terminal to "-Vm" terminal. Connect "CNT" terminal to "TOG" terminal with the attached connector.

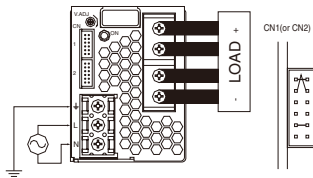

Remote sensing required

Connect "+S" terminal to "+" terminal of load and "-S" terminal to "-" output terminal of load with wires.

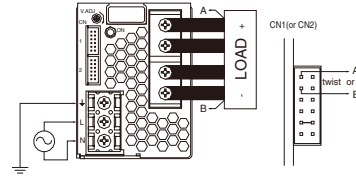

Attached connector when shipping

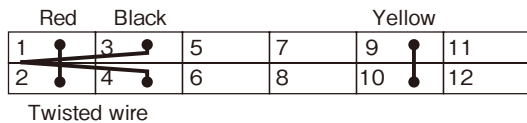

Connecting circuit with CN1 or CN2 connector

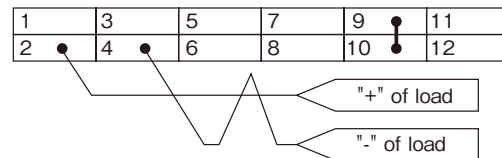

ON/OFF control required

"TOG" terminal is ground for "CNT" terminal.

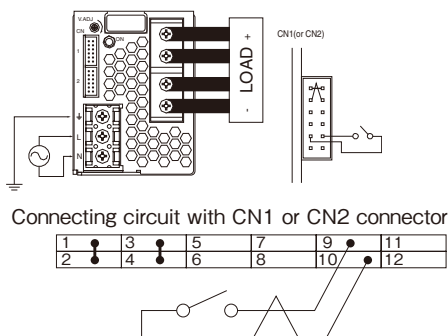

PF signal output required

Open collector method shown below shall be used. "TOG" terminal is ground for "PF" terminal.

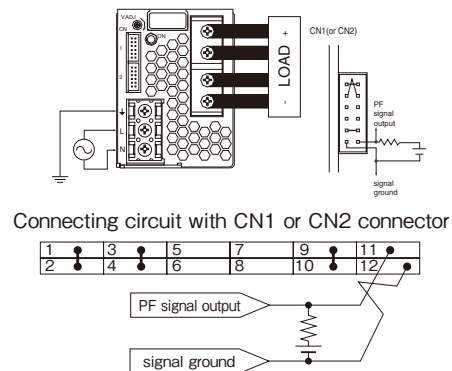

3. Functions and Precautions

1 Input Voltage Range

Input voltage range is single phase 85-265VAC (47-63Hz) or 120-330VDC. Input voltage, which is out of specification, may cause unit damage. Rated input voltage for safety standard application is 100VAC-240VAC (50/60Hz).

2 Output Voltage Range

Output voltage is set to the rated value at shipment. V.ADJ trimmer on the front panel side may be used to adjust the output voltage within the range specified.

Output voltage range is within $\pm 20\%$ of rated output voltage (48V Output Model: -20% to +10%).

To turn the trimmer clockwise, the output voltage will be increased. Take note when the output voltage is increased excessively, over voltage protection (OVP) function may trigger and output voltage will be shut down.

3 Over Voltage Protection (OVP)

The OVP function (inverter shutdown method, manual reset type) is provided. OVP function operates within 125-145% of the rated output voltage value (48V type: 115-135%), and the output will be shut down when OVP function triggers. To reset OVP, remove the input of power supply for a few minutes, and then re-input. Or, use CNT reset (remote ON/OFF: OFF to ON). OVP value is fixed and not to be adjusted externally.

Never apply more than rated output voltage to output terminal, which may lead damage. In the case of inductive load, use decoupling diode at output line.

4 Over Current Protection (OCP)

The OCP function is provided. OCP characteristic is constant current limiting, (less than 5V output model: with Hiccup operation) automatic recovery. OCP function operates when the output current exceeds 105% (24V output model: 119%) of maximum DC output current specification. The output will be automatically recovered when the overload condition is canceled. Never operate the unit under over current or shorted conditions for more than 30 seconds, which may lead damage. OCP setting is fixed and not to be adjusted externally.

5 Over Temperature Protection (OTP)

The OTP function (manual reset type) is provided. When ambient or internal temperature rises abnormally, OTP function operates and output will be shut down. After shut down, remove the input and cool it down to reset OTP.

Then re-input.

6 Low Output Detection Circuit (PF)

Low output voltage detection circuit is provided. Power Fail (PF) signal will turn "High" level to indicate the abnormal status

when the output voltage becomes within 65-80% of rated value caused by either the drop or brownout of the input voltage or OCP, OVP and OTP function operation. When the built-in FAN motor of this power supply unit stops, PF signal will turn to "H". The PF signal is isolated from input and output by a photo-coupler. It uses the open collector method shown below.

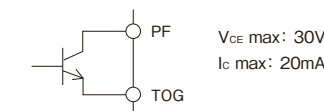

7 Remote Sensing (+S, -S terminal)

This function compensates voltage drop of wiring from output terminals to load terminals. Connect "+S" terminal to "+" terminal of load and "-S" terminal to "-" terminal of load with sensing wires. The total line voltage drop (+ side line and - side line) shall be less than 0.3V. In case that sensing lines are too long, it is necessary to put an electrolytic capacitor in following 3 places;

- 1) across the load terminal,
- 2) between "+S" terminal and "+" terminal,
- 3) between "-S" terminal and "-" terminal.

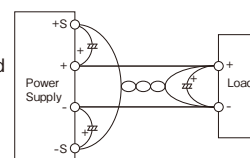

When the function of remote sensing is not used, connect +S terminal to +Vm terminal, and -S terminal to -Vm terminal by the attachment connector.

If remote sensing terminals are opened, the stability and the accuracy of the output deteriorated. Therefore, terminal +S, -S must be connected.

8 Remote ON/OFF Control

Remote ON/OFF control is provided.

Using this function, output on/off is allowed to control without input voltage on/off. The output is turned to ON when TOG and CNT terminals are shorted, and the output is turned to OFF when these terminals are opened. When the function is not used, connect TOG and CNT terminals. The standards for this function are as follows. "TOG" terminal is return for "CNT" terminal.

- (1) TTL compatible. The maximum input voltage to CNT terminal is 12V, and the maximum allowable reverse voltage is -1V. The sink current for CNT terminal is 3.5mA.
- (2) A switch and relay or a transistor can be used as ON/OFF switch.
- (3) Remote ON/OFF control circuit is isolated from the input and output by a photo-coupler and can be controlled regardless of the output potential (+ or -). Connect TOG terminal to ground of control signal.

The mode of control

CNT Level for TOG Terminal	Output	Built-in Fan
Short or L (0V - 0.8V)	ON	Rotate
Open or H (2.4V - 12V)	OFF	Stop

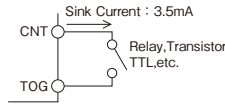

9 Output Ripple & Noise

The standard specification for maximum ripple value is measured specified measurement circuit (JEITA-RC9131A). When load lines are longer, ripple becomes larger. In this case, electrolytic capacitor, film capacitor, etc. might be necessary to use across the load terminal. The output ripple cannot be measured accurately if the probe ground lead of oscilloscope is too long.

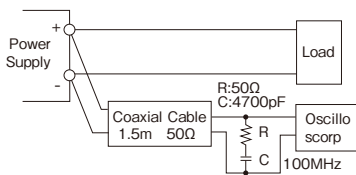

10 Series Operation

For series operation, both method (A) and (B) are possible. There might be a step in the output rise waveform during series operation.

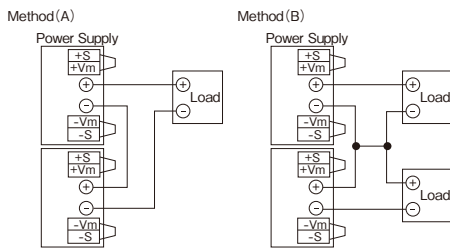

11 Parallel Operation

Current balancing function is provided. Both operations method (A) and (B) are possible.

- (A) To Increase the Output Current

Correct PC to PC terminal and COM to COM terminal, the current balancing function activates and output current of each power supply is equivalently supplied to load. Wires to PC terminals, COM terminals shall be as short as possible and same length and twisted.

 - Adjust the output voltage of each power supply to be same value within 1% or 100mV whichever is smaller.
 - Use same length and type of wires for all load lines.
 - Use the power supply within the rated output current for all paralleled models.
 - Parallel operation is possible up to 5 units.
- (B) To Use as a Backup Power Supply
 - Adjust the output voltage of each power supply to be same value.
 - Set power supply output voltage higher by the forward voltage drop of diode.
 - Use within the specifications for output voltage and output current.

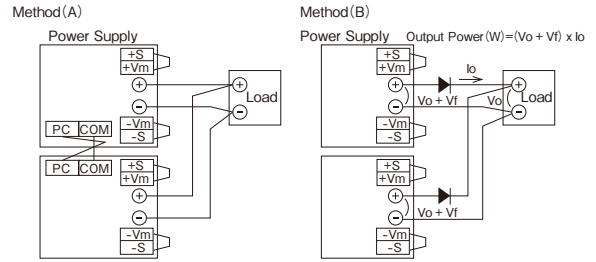

12 Isolation Test

Isolation resistance between output and \perp (chassis) shall be more than 100MΩ at 500VDC and between output and CNT·PF shall be more than 10MΩ at 100VDC. For safety operation, voltage setting of DC isolation tester must be done before the test. Ensure that it is fully discharged after the test.

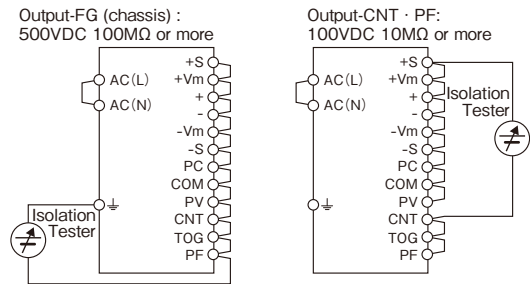

13 Withstand Voltage

This series is designed to withstand 3.0kVAC between input and output, 2.5kVAC between input and \perp (chassis), 500VAC between output and \perp (chassis), and 100VAC between output and CNT·PF terminal each for 1 minute. When testing withstand voltage, set current limit of withstand voltage test equipment at 20mA.

(Output- \perp (chassis) and Output-Control: 100mA). The applied voltage must be gradually increased from zero to testing value and then gradually decreased for shut down. When timer is used, the power supply may be damaged by high impulse voltage at timer switch on and off. Connect input and output as follows.

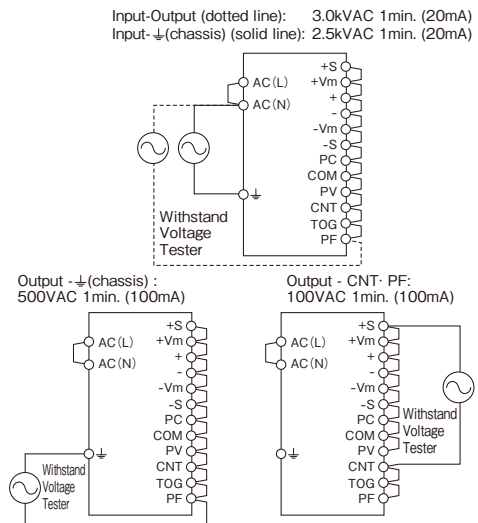

*This product have monolithic ceramic capacitor in secondary circuit to frame ground. Some of the withstand voltage tester may generate high voltage at the matching with monolithic ceramic capacitor and may cause the unit damage.

• All specifications are subject to change without notice.

So, please check the waveform of test voltage.

14 Output Voltage External Control(PV)

Output voltage external control function is available as option with model name followed by "/PV". Output voltage can be varied by applying an external voltage (1-6V) to "PV" terminal and "COM" terminal. Note if an external voltage is not applied, there will be no output. And if the below connection method is attempted with the standard models internal components could be damaged. Please consider the following characteristics.

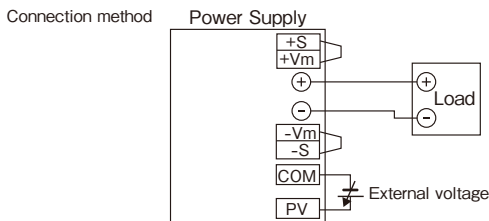

Output Voltage Linearity

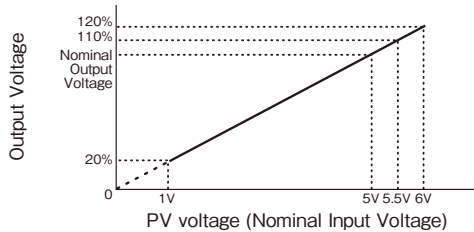

Output Voltage Derating

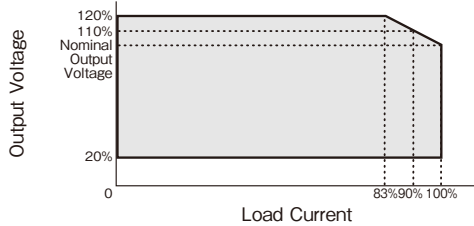

Note 1. Regarding output voltage adjustment below 20%, please consult our sales.

Note 2. For 48V output model only, spaces below must be followed. Limit output voltage variation range at 20%-110%.
At PV voltage variation 1V-5.5V.

15 Output Peak Current

For 24V output model, please meet the following condition. Reduce peak current value according to output derating as section 5-1.

- Input Voltage range: AC180V-265V
- Continuous Peak output time (τ): Within 10 seconds
- Peak output current (I_p): Within the rated peak output current
- Average DC output current (I_m): Within the rated output current

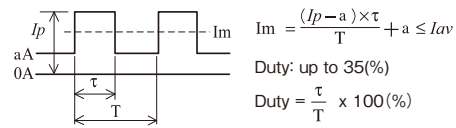

$$I_m = \frac{(I_p - a) \times \tau}{T} + a \leq I_{av}$$

Duty: up to 35%

$$\text{Duty} = \frac{\tau}{T} \times 100(\%)$$

- I_p : Peak output current(A)
- I_{av} : Rated output current (A)
- I_m : Average output current (A)
- τ : Peak current pulse width (sec)
- T : Period (sec)

4. Mounting Directions

1 Output Derating according to the Mounting Directions

Recommended standard mounting method is (A). Method (B) is also possible. Refer to the derating below.

HWS300

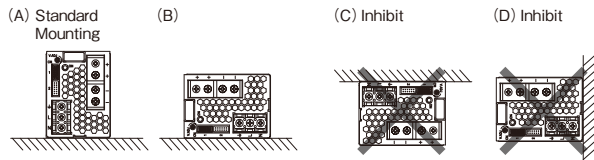

HWS600

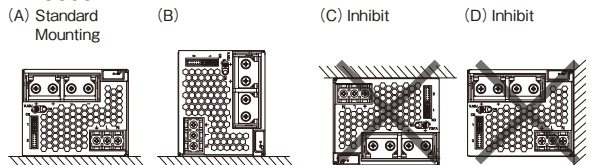

2 Output Derating

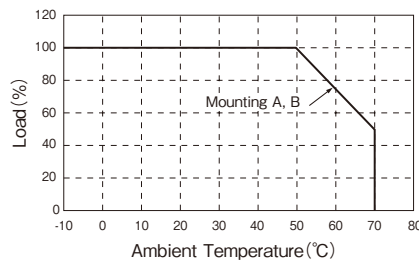

Ta (°C)	Load (%)	
	Mounting (A)	Mounting (B)
-10 to +50	100	100
+70	50	50

3 Mounting Method

- (1) Forced air cooling type power supply.
This power supply has ventilating holes on the front and back side panels. Keep these two areas freely as much as possible.
- (2) The maximum allowable penetration is 6mm.
Incomplete thread of mounting screw should not be penetrated.
- (3) Recommended torque for mounting screw:
M4 screw: 1.27 N · m (13.0kgf · cm)

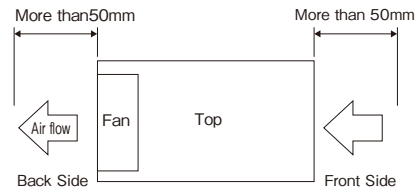

5. Wiring Method

- (1) The output load line and input line shall be separated to improve noise sensitivity.
- (2) The sensing lines shall be twisted and separated from the output lines for remote sensing.
- (3) Use all lines as thick and short as possible to make lower impedance.
- (4) Attaching a capacitor to the load terminals can eliminate noise.
- (5) For safety and EMI considerations, connect \perp terminal to the mounting set ground terminal.
- (6) Recommended torque for the terminal;
HWS600 Output terminal (M5 screw): 2.50 N · m (25.5kgf · cm)
HWS300 Input, Output terminal & HWS600 Input terminal (M4 screw): 1.27 N · m (13.0kgf · cm)

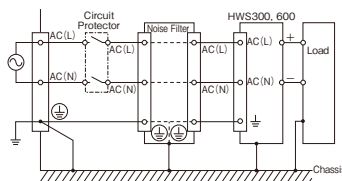

[The PHD connector manufacture method]

This product is using SPHD-001T-P0.5 or SPHD-002T-0.5 connector made from JAPAN SOLDERLESS TERMINAL MFG CO LTD.

Regarding to manufacture of a connector, it becomes the regulation as following.

a). Applicable Wire and Crimping tool

Wire size is AWG#26-AWG#22 and insulation outer dia is ϕ 1.0- ϕ 1.5mm.

Appreciable wire per barrel size is UL1007 (standard wire) and its equivalent standard wire can be used.

Regarding the AWG#22, use UL1061 or its equivalent standard wire, because wire insulation outer diameter of UL1061 is small. Crimping tool is as below.

Crimping tool	Crimping applicator	Dies
AP-K2 or AP-KS	MKS-LS-10 or MKS-L-10	SPHD-001-05/SPHD-002-05

b). Crimping Operation

The reference value of wire strip is 2.3mm. As wire strip length differs depending on type of wire and crimping method, decide the best wire strip length considering processing condition. When wire is stripped, do not damage or cut off wire conductors.

Table of crimp height

SPHD-001T-P0.5

Wire		Insulation O.D (mm)	Crimp height (mm)	
Type	Size		Conductor part	Insulation part
UL1007	AWG #26	1.3	0.60 - 0.70	1.7
UL1007	AWG #24	1.5	0.65 - 0.75	1.8
UL1061	AWG #22	1.4	0.70 - 0.80	1.8

SPHD-002T-P0.5

Wire		Insulation O.D (mm)	Crimp height (mm)	
Type	Size		Conductor part	Insulation part
UL1007	AWG #28	1.2	0.55 - 0.60	1.6
UL1007	AWG #26	1.3	0.60 - 0.65	1.7
UL1007	AWG #24	1.5	0.62 - 0.67	1.8

Note 1. Crimp height at wire barrel should be set to pre-determined dimensions.

Note 2. Adjust crimp height at wire insulation barrel to the extent that wire insulation is slightly pressed, and set it so that crimping is not excessively.

Note 3. Crimping condition at wire insulation barrel is as below

Fig.1.

Note 4. For AWG#28, #26, #24, use UL1007 type. For AWG #22, use UL1061 type.

Fig.1



Good

Fig.2: Examples of defective crimping

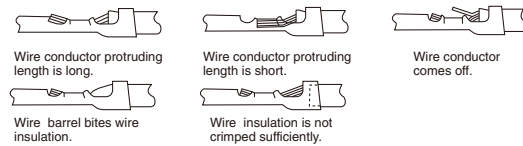

Check of crimping appearance visually for correct crimping as referring to above Fig.2

Check the tensile strength at crimped part when operation finishes.

Table of tensile strength at crimped part.
SPHD-001T-P0.5

Wire size	Requirement N min.	Actual value N
UL1007 AWG#26	20	39.2 - 45.1
UL1007 AWG#24	30	68.6 - 74.5
UL1007 AWG#22	40	92.1 - 96.0

SPHD-002T-P0.5

Wire size	Requirement N min.	Actual value N
UL1007 AWG#28	15	27.0 - 34.3
UL1007 AWG#26	20	44.1 - 48.0
UL1007 AWG#24	30	66.6 - 71.5

c). Inserting contact into housing

Inserting crimped contact into housing

- (1) Do not apply any pulling force to crimped part, and insert contact parallel to housing
- (2) Insert contact into housing without stopping to innermost
- (3) Check secure locking per each insertion by pulling wire softly in order to check that contact does not come off housing. Besides, check whether there is the backlash in the direction of insertion axis.

Defect example of slation insertion

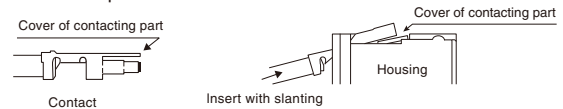

d). Mating and Unmating Connector

(1) Inserting connector

Hold receptacle housing securely and insert into header straight against to header post until click sounds.

(2) Unmating connector

Hold all wires securely and fix receptacle housing by fingers so as to pry, and then, withdraw it on the mating axis.

Fix receptacle housing Hold all wires



e). Routing of Wire

Routing wire so as not to apply external force to connector except force to such an extent that wire slightly buckles, considering an enough length to route and fixing of wire.

6. External Fuse Rating

Refer to the following fuse rating when selecting the external fuses that are to be used on input line. Surge current flows when line turns on. Use slow-blow or time-lag type fuse, not fast-blow fuse. Fuse rating is specified by in-rush current value at line turn-on. Do not select the fuse according to input cur-

rent (RMS.) values under the actual load condition.

HWS300 : 10A
HWS600 : 15A

7. Fan life expectancy

The Fan-life has limitation. Therefore, periodic maintenance by exchanging the life-expired fan is required for the power supply. The following figure shows the life of fan.

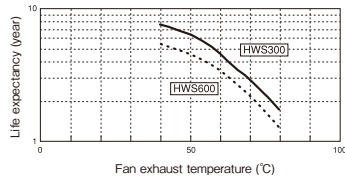

Measurement point of fan exhaust temperature

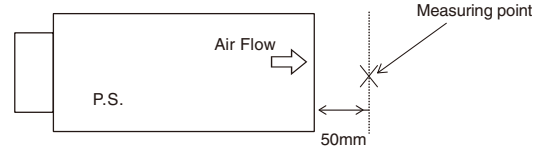

The difference between the intake temperature and the exhaust temperature of the power supply at Io=100% :

HWS300: 4°C
HWS600: 8°C

8. Before concluding that the unit is at fault...

Before concluding that the unit is at fault, make the following checks.

- (1) Check if the rated input voltage is connected.
- (2) Check if the wiring of input and output is correct.
- (3) Check if the I/O terminal connection is properly tightened by regulated torque.
- (4) Check if the wire thickness is enough.
- (5) Check if the output voltage control (V.adj) is properly adjusted. OVP might be triggered and output is shut down.
- (6) If use function of the Remote ON/OFF control, check if the Remote ON/OFF control connector is not opened. If in open condition, power supply will not output.
- (7) Check if the built-in FAN is not stopped. Is FAN stopped by

something irregulars or etc?

If FAN stops, the PF signal turn "High" level and OTP might be activated.

- (8) Power supply has ventilating holes on the front and back panels. Check if there is any irregulars or dust, etc.
- (9) Is the chassis of power supply hot abnormally? The output is shut down by OTP operation. Please re-input after the unit to cool down sufficiently.
- (10) Check if the output current and output wattage does not exceed specification.
- (11) Audible noise can be heard when input voltage waveform is not sinusoidal.
- (12) Audible noise can be heard during dynamic load operation.

9. Range of free warranty

This product is warranted for a period of 5 years from the date of shipment. As for the breakdown under a normal use during free warrantee term, repair is at free of charge. However, the built-in FAN motor replacement is charged. Please contact to our sales office for FAN replacement.

Conditions of usage at the free of charge warrantee are as follows.

- (1) Average operating temperature (ambient temperature of the power supply unit) is under 40°C
- (2) Average load factor is 80% or less.

- (3) Installation method : Standard installation. However, the maximum rating is within the output derating.

Following cases are not covered by warranty.

- (1) Improper usage like dropping products, applying shock and defects from operation exceeding specification of the units.
- (2) Defects resulting from natural disaster (fire, flood).
- (3) Unauthorized modifications or repair by the buyers defects not cause by TDK-Lambda.

10. Option

1 Fan unit for replacement

We have prepared an optional fan unit for replacement.

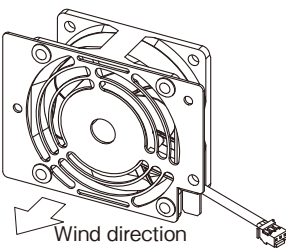
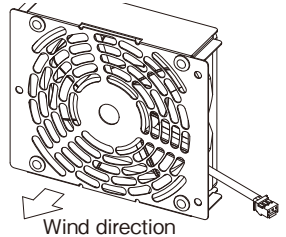
Name of fan unit for replacement	Applicable models	Appearance	Pin assignments	Price								
300-FAN-01	HWS300 (of standard specifications)		Housing = PAP-03-V-S (J.S.T.) Contact = SPHD-001T-P0.5 or PSHD-002T-P0.5 (J.S.T.) <table border="1"> <tr><th>Pin No.</th><th>Description</th></tr> <tr><td>1</td><td>Power supply</td></tr> <tr><td>2</td><td>Fan alarm</td></tr> <tr><td>3</td><td>GND</td></tr> </table> Length of fan harness = 55 ± 10mm	Pin No.	Description	1	Power supply	2	Fan alarm	3	GND	Open
Pin No.	Description											
1	Power supply											
2	Fan alarm											
3	GND											
600-FAN-01	HWS600 (of standard specifications)		Housing = PAP-03-V-S (J.S.T.) Contact = SPHD-001T-P0.5 or PSHD-002T-P0.5 (J.S.T.) <table border="1"> <tr><th>Pin No.</th><th>Description</th></tr> <tr><td>1</td><td>Power supply</td></tr> <tr><td>2</td><td>Fan alarm</td></tr> <tr><td>3</td><td>GND</td></tr> </table> Length of fan harness = 70 ± 10mm	Pin No.	Description	1	Power supply	2	Fan alarm	3	GND	Open
Pin No.	Description											
1	Power supply											
2	Fan alarm											
3	GND											

Ask us for replacement of the fan. This will be a charged service. If you are replacing the fan by yourself, note the following.

*1. Be careful in handling the fan unit so as not to cause an impact by dropping it or hitting it, etc.

*2. Shut down the input before starting the replacement operation.

*3. Check that there are no loose parts in connectors or harness tucking, etc.

HWS 1000 Series Instruction Manual

BEFORE USING THE POWER SUPPLY UNIT

Be sure to read the following precautions thoroughly before using this power supply unit.

Pay attention to all warnings and cautions before using the unit. Incorrect usage could lead to an electric shock, damage to the unit or a fire hazard.

WARNING

- Do not make unauthorized changes to power supply unit, otherwise you may have electric shock and void your warranty.
- Do not touch the internal components; they may have high voltage or high temperature. You may get electric shock or burned.
- When the unit is operating, keep your hands and face away from it; an accident may injure you.
- Do not use unit under unusual condition such as emission of smoke or abnormal smell and sound etc. It might cause fire and electric shock.
In such case, please contact us; do not repair by yourself, as it is dangerous for the user.
- Do not drop or insert anything into unit. It might cause failure and fire, when using the unit under such condition.
- Do not operate these units at the condition of condensation. It may cause fire and electric shock.
- Power supplies with an output voltage of 48Vdc or less must be earthed in the end use equipment to maintain SELV. If the outputs are not earthed, they must be considered hazardous and must not be made user accessible.
- Power supplies with an output voltage of 60Vdc are considered to be non-SELV. As a result of this, the output must be guarded or a deflector fitted during installation to avoid a SERVICE ENGINEER making inadvertent contact with the output terminals, or dropping a tool onto them. The output of this product must not be connected to a SELV circuit.

Note : CE MARKING

- CE Marking when applied to a product covered by this handbook indicates compliance with the low voltage directive (2006/95/EC) in that it complies with EN60950-1.

CAUTION

- This power supply is primarily designed and manufactured to use and enclose in other equipment.
- This power supply unit has a built-in fan for air-cooling. Do not block air intake and exhaust. It might cause fire.
- Input voltage, output current, output power, ambient temperature and ambient humidity should be used within specifications, otherwise the unit will be damaged.

- The unit might be broken down by accident or unexpected situation. For application equipment, which requires very high reliability (nuclear related equipment, traffic control equipment, medical equipment, etc.), please provide fail safety function in the equipment.
- Do not make an improper wiring to input and output terminals. It may cause damage.
- Do not use in environment such as strong electromagnetic field, erosive gas etc, or any environment where conductive foreign substance may enter.
- Do not operate and store this unit at the condition of condensation. In such case, waterproof treatment is necessary.
- Do not operate this unit after it falls down.
- The output voltage of this power supply unit is considered to be a hazardous energy level (The voltage is 2V or more and the electric power is 240VA or more), prevention from direct contact with voltage output is highly necessary. While installing or servicing this power supply unit, avoid dropping tools by mistake or direct contact with voltage output. This might cause an electrical shock.
While repairing this power supply unit, the AC input power must be switch off and the I/O terminal voltage should be less than the safety level.

CAUTION of IEC/EN/UL60601-1 for HWS1000/ME

CAUTION

- These products are designed for continuous operation within an overall enclosure, and must be mounted such that access to the mains terminals is restricted. See Clause 16, IEC/EN/UL60601-1.
- These products are NOT suitable for use in the presence of flammable anaesthetic mixtures with air or with oxygen or with nitrous oxide.
- Connect only apparatus complying with IEC/EN/UL60601-1 to the signal ports.
- Except for permanently installed equipment as defined in Clause 57.6 of IEC/EN/UL60601-1 the overall equipment in which these products are installed must have double pole fusing on the input mains supply. The products themselves have single pole fusing in the live line.
- These products provide basic insulation only between mains and output, with reference to IEC/EN/UL60601-1. Sure to add supplemental insulation to input or output in the equipment.
- Reference should be made to local regulations concerning the disposal of these products at the end of their useful life.
- The maximum normal leakage current of this product is 500 microamperes for IEC/EN/UL60601-1. When using it as a patient care equipment, all outer surfaces of the equipment shall be constructed of nonconductive material. See Clause 19.5DV.2 of UL60601-1.
- These products have not been assessed to IEC/EN60601-1-2 (EMC) but EMC test data is available from TDK-Lambda.

1. Terminal Explanation

Please pay extra attention to the wiring. Incorrect connection will damage the power supply.

- When connecting input and output wiring, input AC-Line should be off.
- Input wiring and output wiring shall be separated, otherwise noise susceptibility of power supply unit will be weak.

- The protective earth (PE) must be connected to the instrument chassis and the chassis of this power supply unit.
- Remote sensing lines shall be twisted or use the shielded wire.
- Remote ON/OFF control lines shall be twisted or use the shielded wire.

1 Front Panel Explanation

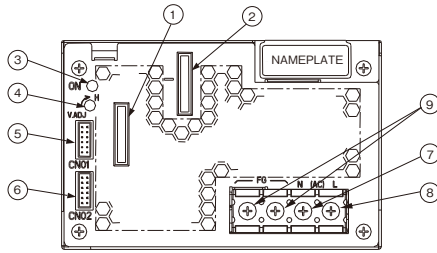

- ① +: + Output terminal
- ② -: - Output terminal
- ③ ON: Output (Power On) indication green LED (The indicator turns on when the power supply output is in normal operating condition.)
- ④ V.ADJ: Output voltage adjust trimmer (The output voltage rises when trimmer is turned clockwise.)
- ⑤ CN01: } Remote sensing, ON/OFF control signal, Current balance signal,
- ⑥ CN02: } Output voltage external control signal and Power fail signal output connector.
- ⑦ N: AC input terminal N : Neutral line
- ⑧ L: AC input terminal L : Live Line (Fuse in line)
- ⑨ FG: Function Ground terminal (Frame ground)

2 CN01, CN02 Connector pin configuration and function

CN01, CN02 pin configuration and function are the same.

They are connected to each other in this power supply unit.

When the pin of CN01 side is shorted the same function pins of CN02 side are shorted.

Please note that the function cannot be separately set with CN01 and CN02.

	Pin No.	Configuration	Function
	1	+V	Connected to +Output terminal in this power supply unit. (+V terminal can not supply load current.)
	2	+S	Remote sensing terminal for +Output (For remote sensing function, which compensates for line drop between power supply terminals and load terminals. Connect to +V terminal when remote sensing function is unnecessary.)
	3	-V	Connected to -Output terminal in this power supply unit. (-V terminal can not supply load current.)
	4	-S	Remote sensing terminal for -Output (For remote sensing function, which compensates for line drop between power supply terminals and load terminals. Connect to -V terminal when remote sensing function is unnecessary.)
	5	PC	Current balance terminal (For output current balancing in parallel operation.)
	6	COM	Ground for PC and PV signal.
	7	PV	Output voltage external control terminal (For power supply output voltage control with an external voltage. Connect it with the terminal REF when PV function is unnecessary.)
	8	REF	Reference voltage terminal for Output voltage control (REF and PV are connected when shipping.)
	9	CNT	Remote ON/OFF control terminal (When the CNT is pulled to TTL low, the power supply turns on.)
	10	TOG	Ground for CNT and PF signal.
	11	PF	Power fail signal output terminal. (As the output voltage drops, FAN stops and AC input voltage down, open collector output, "Power Fail" signal will output "High".)
	12	TOG	Ground for CNT and PF signal.

CN01, CN02 are connected in this power supply unit as follows.

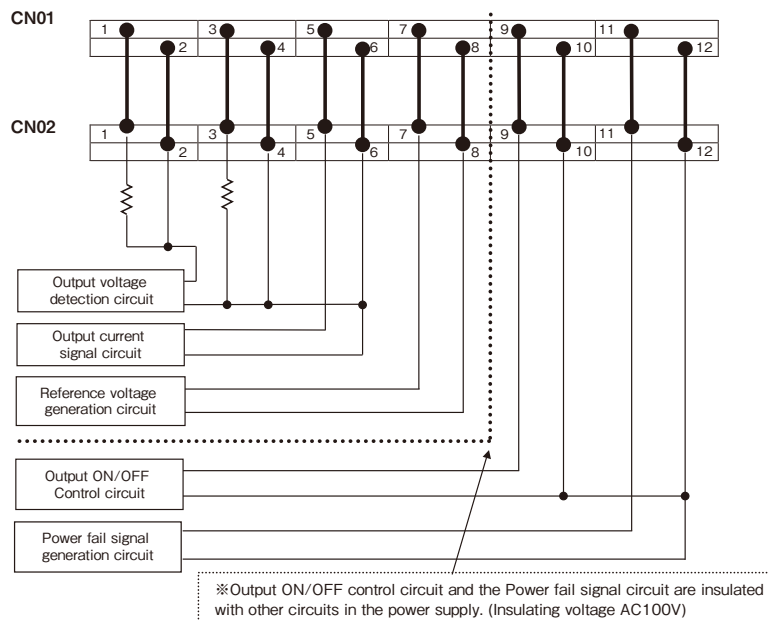

3 Basic Connection (Local sensing)

- ① Connect "+S" terminal to "+V" terminal and "-S" terminal to "-V" terminal with sensing wires.
 - ② Connect "CNT" terminal to "TOG" terminal with wire.
 - ③ Connect "PV" terminal to "REF" terminal with wire.
- ※ Please use attachment connector for each connection.
- ※ In the following cases, the output is shut down.
- When CNT and TOG is opened.
 - When PV and REF is opened.

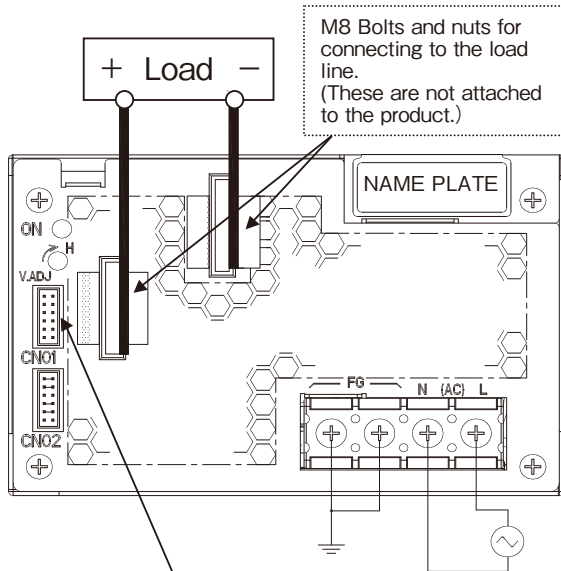

Connector : (JST) S12B-PHDSS

Attached connector when shipping

- Housing : (JST) PHDR-12VS
- Contact : (JST) SPHD-001T-P0.5

1-2, 3-4, 7-8, 9-10 are shorted.

Attached connector when shipping

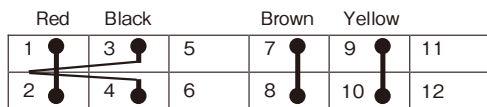

Twist wire

4 Remote sensing required

- ① Connect "+S" terminal to "+" terminal of load with sensing wire.
 - ② Connect "-S" terminal to "-" terminal of load with sensing wires.
 - ③ Connect "CNT" terminal to "TOG" terminal with wire.
 - ④ Connect "PV" terminal to "REF" terminal with wire.
- ※ The accuracy of the output voltage will deteriorate when the sensing terminals are opened.
- ※ In the following cases, the output is shut down.
- When CNT and TOG is opened.
 - When PV and REF is opened.

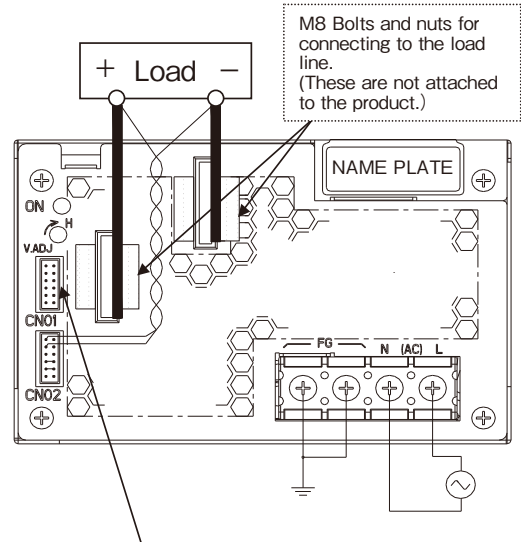

Connector : (JST) S12B-PHDSS

Remove standard attached connector, and use the harness made by the customer.

- Housing : (JST) PHDR-12VS
- Contact : (JST) SPHD-001T-P0.5

2-"+" of load, 4-"-" of load should be connected.

7-8, 9-10 : should be shorted

*Please use wire for contact and crimping tool specified by maker.

Connecting circuit with CN01 or CN02 connector

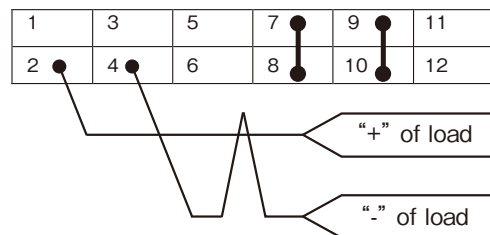

5 Remote ON/OFF control required

- ① Remove standard attached connector, and use the harness made by the customer and connect external signal to between CNT and TOG terminal.
 - ② "TOG" terminal is ground for "CNT" terminal.
- In case this function is not used, please short between CNT and TOG terminal.

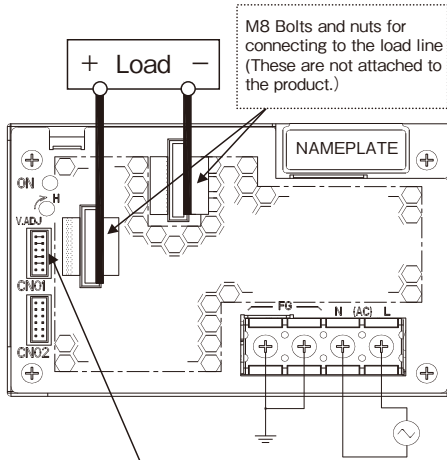

Connector : (JST) S12B-PHDSS

Remove standard attached connector, and use the harness made by the customer.

- Housing : (JST) PHDR-12VS
- Contact : (JST) SPHD-001T-P0.5

1-2, 3-4, 7-8 : should be shorted
 9 : CNT
 Should be connected to ON/OFF control signal.
 10 : TOG
 Should be connected to Signal Ground.
 * Please use wire for contact and crimping tool specified by maker.

6 PF signal output required

- ① PF signal is an open collector output, therefore PF signal outputs is shown in circuit below.
- ② "TOG" terminal is ground for "PF" terminal.

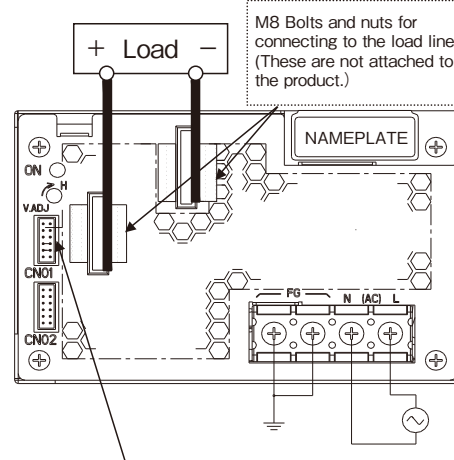

Connector : (JST) S12B-PHDSS

Remove standard attached connector, and use the harness made by the customer.

- Housing : (JST) PHDR-12VS
- Contact : (JST) SPHD-001T-P0.5

1-2, 3-4, 7-8, 9-10 : should be shorted.
 11 : PF
 Should be connected to PF signal output
 12 : TOG
 Should be connected to Signal Ground.
 * Please use wire for contact and crimping tool specified by maker.

Connecting circuit with CN01 or CN02 connector

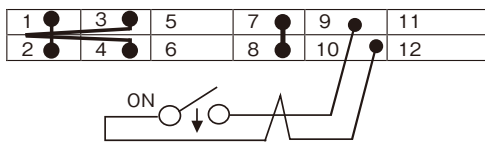

Connecting circuit with CN01 or CN02 connector

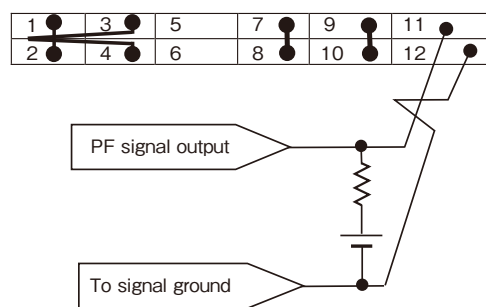

2. Functions and Precautions

1 Input Voltage Range

Input voltage range is single phase 85–265VAC (47–63Hz). Input voltage, which is out of specification, may cause unit damage. Rated input voltage range fix during safety standard application is from 100V to 240VAC (50/60Hz).

While applying input voltage from 85VAC to 90VAC, output load current derating is required.

2 Output Voltage Range

Output voltage is set to the rated value at shipping. V.ADJ trimmer on the front panel side is use to adjust the output voltage within the range specified. Output voltage trimming range is within -20%–+20% of the rated output voltage (48V, 60V model: -20%–+10%). Turn the trimmer clockwise to increase output voltage. Take note when the output voltage is increased excessively over voltage protection (OVP) function may trigger and output voltage will shut down.

Use the output power of the power supply below the rated output power value when you raise the output voltage.

3 Over Voltage Protection (OVP)

The OVP function (Inverter shut down method, manual reset type) is provided. OVP function operates within 125-145% of the rated DC output voltage value (3-7V model: 125-140%, 36V model: 125-138%, 48V, 60V model: 115-125%), and the output will be shut down when OVP function triggers. When OVP function operates, the input power is cut off for a few minutes, and then power is re-input or remote ON/OFF control signal shall be input for recovery of the output. OVP value is fixed and can not be adjusted.

4 Over Current Protection (OCP)

The OCP function (Constant current limiting, Time delay shutdown type) is provided. OCP function operates when the output current exceeds 105% of maximum DC output current specification and the over current or short circuit condition continues 5-second or more, the output will be shut down. When the OCP is triggered, the input power is cut off for a few minutes, and then power is re-input or remote ON/OFF control signal should be input for recovery of the output. The OCP setting is fixed and not to be adjusted externally.

5 Over Temperature Protection (OTP)

Over temperature protection function (manual reset type) is provided. When ambient or internal temperature rises abnormally, OTP will shut down the output. When OTP is triggered, input power is cut off and allow sufficient cooling to reset the OTP function. Then power is re-input or remote ON/OFF control signal should be input for recovery of the output.

6 Low Output Detection Circuit (PF)

Low output voltage detection circuit is provided. Power Fail signal (PF signal) will output when output voltage decrease by either the drop or brown out of the input voltage or OCP, OVP and OTP function operation. PF signal will turn "High" level to indicate the abnormal status of the power supply when the output voltage decrease to 80% of the output voltage setting value. However, there is a possibility that PF signal may not output during parallel operation. The PF signal circuit is insulated from the power supply input and output circuit and it is an open collector. TOG terminal is ground for PF terminal.

When the Built-in Fan Motor of this power supply unit stops, PF signal will turn to "H" and the output power will shut down. The Built-in Fan Motor is a component with lifetime. We recommend a periodic replacement. Please contact our sales office. Replacement is at customer's expenses.

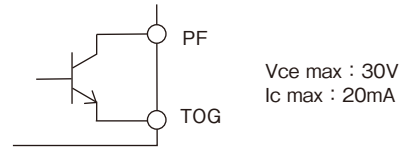

7 Remote Sensing (+S, -S terminal)

Remote sensing function is provided to compensate for voltage drop across the wiring from the power supply output terminals to the load input terminals. Connect "+S" terminal to "+" terminal of the load and "-S" terminal to "-" terminal of the load with sensing wires. The total line voltage drop (+ side line and - side line) shall be less than 0.3V. In case that sensing line is too long, it is necessary to put an electrolytic capacitor across the load terminals.

Please take note that the electrolytic capacitor has generation of heat etc. done by the ripple current depending on connected load. Therefore, the electrolytic capacitor must have a ripple current allowance higher than the output ripple current. If CN01 (or CN02) is in use, terminal +S, -S for CN02 (or CN01) must be in open condition.

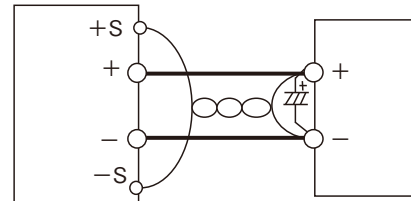

When the function of remote sensing is not in used, connect +S terminal to +V terminal, and -S terminal to -V terminal by the attachment connector.

If remote sensing terminals are opened, the stability and the accuracy of the output deteriorate. Therefore, terminal +S, -S must be connected.

8 Remote ON/OFF Control

Remote ON/OFF control is provided. Output can be remotely switch ON and OFF by using CNT terminal and TOG terminal even though input is connected. The output is turned to ON when TOG and CNT terminals are shorted and output is turned to OFF when these terminals are opened. When the function is not used, connect TOG and CNT terminals with short piece. The standards for this function are as follows. "TOG" terminal is ground for "CNT" terminal.

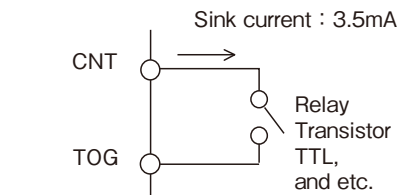

The Mode of control

CNT Level for TOG Terminal	Output	Built-in Fan Motor
Short or L (0–0.8V)	ON	Rotate
Open or H (2.4–12V)	OFF	Stop

- 1) TTL compatible. The maximum input voltage to CNT terminal is 12V, and the maximum allowable reverse voltage is -1V. The sink current of CNT terminal is 3.5mA.
- 2) Output ON/OFF control can be enable by a switch, relay or a transistor ON/OFF. When CNT terminal—TOG terminal is shorted power supply is turn ON, and when CNT terminal—TOG terminal is opened power supply is turn OFF.
- 3) Remote ON/OFF control circuit is isolated from the input and output circuit of power supply.

It is possible to use it regardless of the positive and negative of the power supply output.

Please be aware that if CNT terminal and TOG terminal is short and input voltage is gradually increase, this will trigger the low output voltage detector protection circuit and will result to output voltage shut down.

When the low output voltage detector protection circuit is triggered, the input power is cut off for a few minutes, and then power is re-input or remote ON/OFF control signal should be input for recovery of the output.

9 Output Ripple & Noise

Maximum ripple & noise value in specifications is measured according to measurement circuit specified by JEI-TA-RC9131A. When Load lines are longer, ripple & noise becomes larger. In this case, electrolytic capacitor, film capacitor, etc. might be necessary to use across the load terminal. The output ripple & noise cannot be measured accurately if the probe ground lead of oscilloscope is too long.

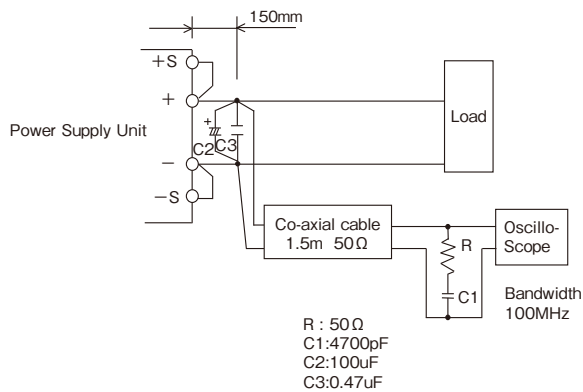

10 Series Operation

For series operation, either method (A) or (B) is possible. There might be a step in the rise waveform during series operation.

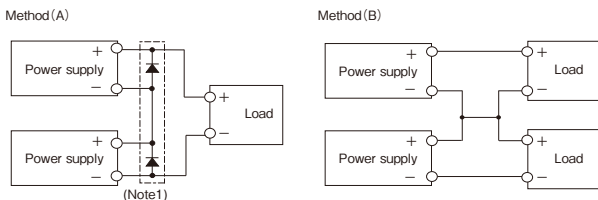

(Note1) Please connect a diode for by-pass when using method (A) of the series operation.

Please use the diode with rated forward current is equal or more than load current and that the rated maximum reverse voltage is higher than output voltage for each power supply.

11 Parallel Operation

Current balancing function is provided. Either of operations mode (A) or (B) is possible.

(A) To Increase the Output Current

Current balancing function activates by connecting PC-to-PC terminal and COM-to-COM terminal, and output current of each power supply is equivalently

supplied to load. Wires to PC terminals shall be as short as possible, same length and twisted.

There is a possibility that output could be unstable caused by external noise. For this case, disconnect COM terminal and connect -S terminal from parallel power supply to a single point on the load. Please refer connection Method (A)-2.

- 1) Adjust the output voltage of each power supply to be same value within 1% or 100mV, whichever is smaller.
- 2) Use same length and type of wires for all load lines.
- 3) Maximum value of output current in parallel is up to 80% of all paralleled models. The purpose of the current balancing function is the static power-up. Therefore the output voltage might decrease according to the condition of dynamic load. There might be a step in the rise waveform during parallel operation.
- 4) Up to 5 units can be connected in parallel.

(B) To Use as a Backup Power Supply

- 1) Set power supply output voltage higher by the forward voltage drop of diode.
- 2) Adjust the output voltage of each power supply to be same value.
- 3) Use within the specifications for output voltage and output power.

Method (A)-1

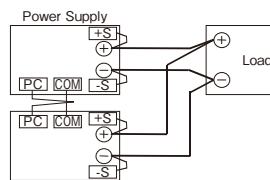

Method (A)-2

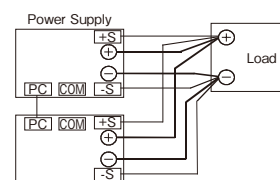

Method (B)

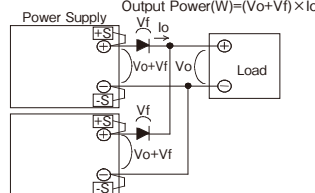

12 Isolation Test

Isolation resistance between output and FG (chassis) shall be more than 100MΩ at 500VDC and between output and CNT·PF shall be more than 10MΩ at 100VDC. For safety operation, voltage setting of DC isolation tester must be done before the test. Ensure that it is fully discharged after the test.

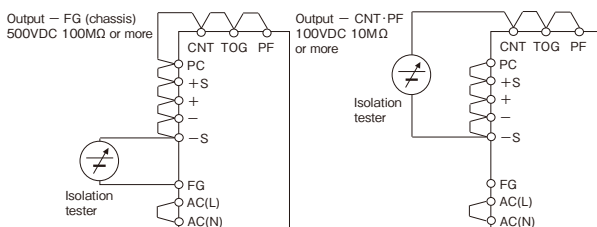

13 Withstand Voltage

This series is designed to withstand 3.0kVAC between input and output, 2.0kVAC between input and FG (chassis), 500VAC (60V model : 651VAC) between output and FG (chassis), and 100VAC between output and CNT·PF terminal each for 1 minute. When testing withstand voltage, set current limit of withstand voltage test equipment at 20mA.

(Output-FG (chassis) : 300mA (60V model : 390mA), Out

put- CNT·PF : 100mA).
 The applied voltage must be gradually increased from zero to testing value and then gradually decreased for shut down. When timer is used, the power supply may be damaged by high impulse voltage at timer switch on and off. Connect input and output as follows. If output is left open during test, output voltage might appear momentarily. This product have monolithic ceramic capacitor in secondary circuit to frame ground. Some of the withstand voltage tester may generate high voltage at the matching with monolithic ceramic capacitor and may cause the unit damage. So, please check the waveform of test voltage.

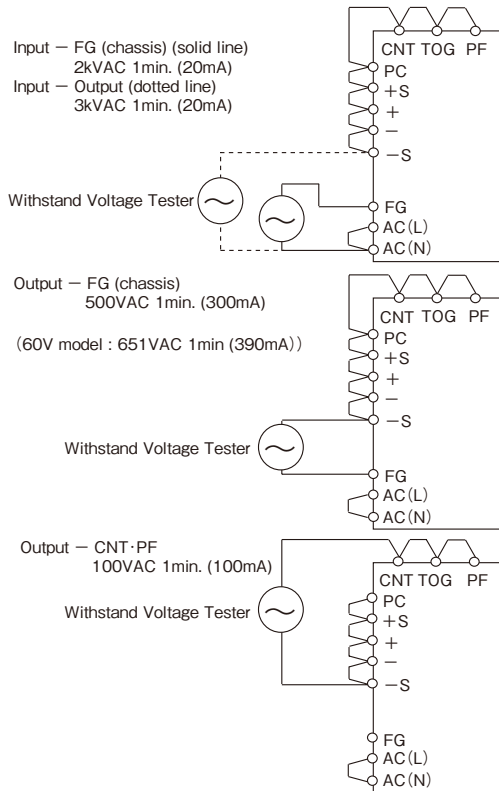

14 Output Voltage External Control (PV)

(A) Control by External Voltage

Output voltage external control function is provided. Output voltage can be varied by applying an external voltage (1-6V) to "PV" terminal and "COM" terminal. Note if an external voltage is not applied, there will be no output. Please consider the following characteristics below when operating the unit.

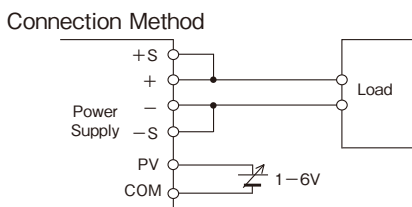

Output Voltage Linearity

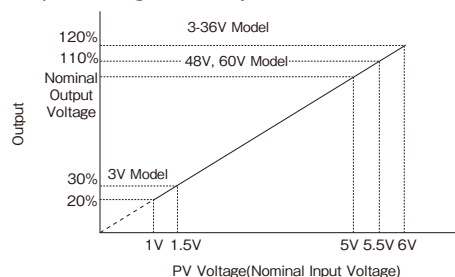

Note: Only as for the model of 3V output, the output voltage is used from 30% to 120% at the PV voltage is from 1.5V to 6.0V

Note: Only as for the model of 5-36V output, the output voltage is used from 20% to 120% at the PV voltage is from 1V to 6.0V

Note: Only as for the model of 48V, 60V output, the output voltage is used from 20% to 110% at the PV voltage is from 1V to 5.5V.

Output Voltage Derating

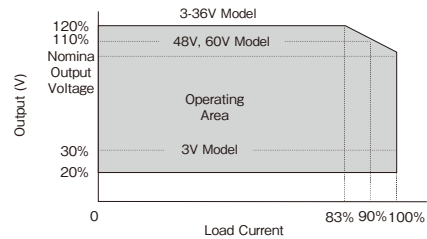

Note: Only as for the type of 48V, 60V output, the maximum output voltage is used up to 110% at 90% load current.

(B) Control by External Variable Resistor

"PV" terminal and "COM" terminal usage is the same as explained in section ["control by external voltage"]. But in this method voltage for control is supplied through REF terminal. Variable resistor is connected between REF terminal and COM terminal and the middle point of variable resistor is connected to PV terminal. Please use the output voltage within 20% - 120% of rated output voltage value (3V model : 30% - 120%, 48V, 60V model : 20% - 110%). Wires for control lines must be twisted wire or shielded wire. In addition, maximum variable voltage when control by external variable resistor is rated output voltage (100%). When output voltage must be externally control to 120% of rated output voltage (110% for 48V, 60V model), please follow the following procedure.

- (1) PV terminal and REF terminal is short by using standard connector supplied.
- (2) Set the power supply output voltage to maximum value of the output voltage variable range mentioned in specification standard by adjusting V.ADJ volume at the front panel.
- (3) Remove standard connector after input is cut off.
- (4) Connect external variable resistor (50kΩ) between REF terminal and COM terminal. Then connect middle point of external variable resistor to PV terminal. (sensing current is 1.4mA)

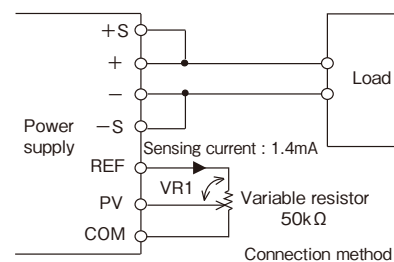

When output voltage is over rated value, please make sure that maximum output power is below rated value. Moreover, when output voltage is below rated value, please make sure that maximum output current is below rated value.

Please consider the following characteristic during usage.

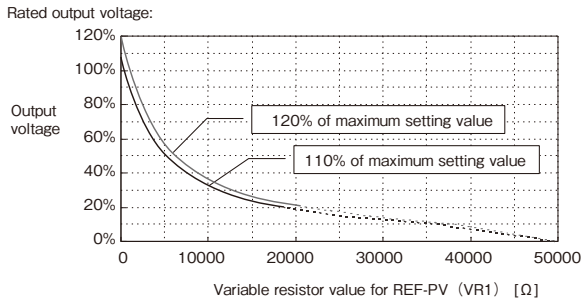

* Adjustable output voltage within 20%(3Vmodel : 30%) of output (less than 1V of PV voltage) is proportional to PV voltage and has a linear characteristic. However, for output voltage within 10% of output (about less than 0.5V of PV voltage), output will go into intermittent mode and ripple voltage becomes large, also irregular sound is release from the power supply. However, it is not damage. There will also be cases of the power supply shutting down triggered by under voltage lock out protection function. With output shutting down, low output detection function (PF) triggers the PF signal and set it to "H", and also output LED is switch off. Under voltage lock out protection mode, switch off input for a few minutes and then switch on input again for recovery. Recovery from under voltage lock out is also possible by turning remote ON/OFF control signal OFF and ON. Under voltage detection value uses an automatic tracking mode, which follows the output voltage and constantly correspond to the 70%-80% of output voltage with a protection function mode. Base on the explanation above, we will kindly exclude the usage of adjustable output voltage within 20% of the output voltage from the product warranty. For application that requires variable output voltage within 20% of output voltage, please kindly consider the above contents prior to operation. For application that requires output voltage below 20%, due to different type of application for the user's system, there might be a situation (behavior) different from the one mentioned above. Therefore please check with the user system.

15 Output Peak Current

For model with output peak current, please meet the following condition.

Reduce peak current value according to output derating as section 4-1.

The output is shut down by protection circuit when rated current and continuous peak output time (τ) exceeds rated value during usage.

When protection circuit is activated, input is temporarily cut off for a few minutes and then power is re-input or remote ON/OFF control signal should be input for recovery of the output.

- Input voltage range : AC180V - 265V
- Continuous Peak output time (τ) : Within 10 seconds
- Peak output current (I_p) : Within the rated peak output current
- Duty : up to 35%

$$\text{Duty} = \frac{\tau}{T} \times 100 (\%)$$

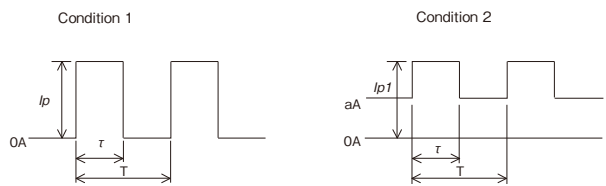

$$\sqrt{I_p^2 \times \frac{\tau}{T}} \leq I_{rms \max} \quad \sqrt{I_{p1}^2 \times \frac{\tau}{T} + a^2 \times (1 - \frac{\tau}{T})} \leq I_{rms \max}$$

- I_p, I_{p1} : Peak output current (A)
- I_{rms} : Effective current (A)
- τ : Peak current pulse width (sec)
- T : Cycle (sec)

Model	$I_{rms \max}$
HWS1000-7	94.6A
HWS1000-12	59.1A
HWS1000-15	47.3A
HWS1000-24	34.6A
HWS1000-36	23.0A
HWS1000-48	17.2A
HWS1000-60	13.8A

3. Mounting Directions

1 Output Derating

Mounting directions are as follows.
 Standard mounting method is (A). Methods (B), (C), (D), (G) and (H) are also possible.
 Mounting methods besides (A), (B), (C), (D), (G) and (H) (example : (E) and (F)) are inhibited.

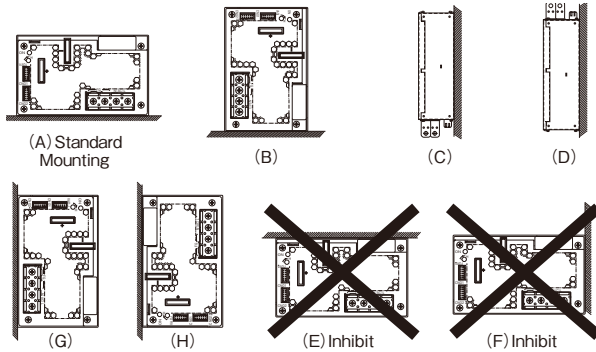

HWS1000 Output Derating

3, 5V Ta(°C)	6-60V Ta(°C)	LOAD (%)					
		A	B	C	D	G	H
-10 - +35	-10 - +35	100					
40	50	100					
71	71	50					

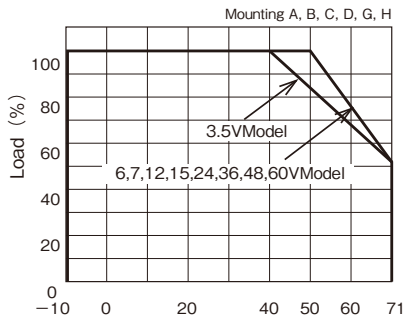

2 Mounting Method Caution

- (1) This Power supply unit is a forced air-cooling system with a built-in fan.
- (2) This power supply has ventilating holes on the front and back panels.
 Keep these areas freely more than 100mm from front side and more than 50mm from rear side.
- (3) Please note that ventilation will be worsened in a dusty environment.
- (4) Built-in fan is limited life part, which require periodic replacement. (Replacement will be charged).
- (5) The ambient temperature of this power supply is less than 50mm from the center of a front side.
- (6) The maximum allowable penetration of mounting screw is 6mm.
- (7) Recommended torque for mounting screw (M4) is 1.27N·m.

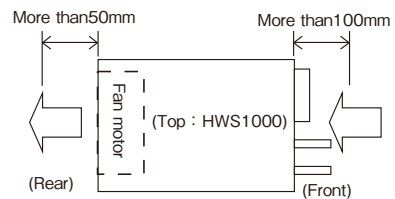

HWS

HWS HD

HWS ME

HWS-P

Instruction Manual

4. Wiring Method

- (1) The output load line and input line shall be separated and twisted to improve noise sensitivity.
- (2) The sensing lines shall be twisted or shield wire and separated from the output lines.
- (3) Use all lines as thick and short as possible to make lower impedance. Wires are to be twisted or use shield wire to improve noise sensitivity.
- (4) Attaching a capacitor to the load terminals can eliminate noise.
- (5) FG terminal of this power supply is functional earthing. For safety purposes, connect protective earthing terminal to the mounting set ground terminal.
- (6) Recommended torque for the terminal piece:

Input terminal (M4 screw):	1.27 N·m
Output terminal (M8 Bolt & Nut):	10.8N·m

- (7) Recommended wiring

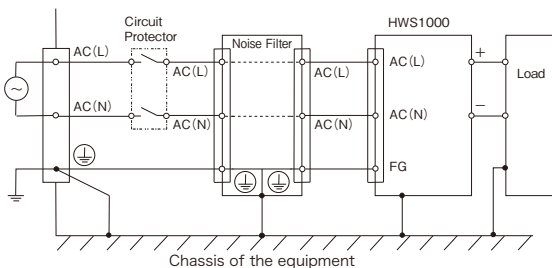

Recommended circuit protector: AC250V20A
 Recommended noise filter: RSEN-2020 (TDK-Lambda)

- (8) M4 screw for output terminal might damage the terminal's inner thread. This is mainly cause by the M4 screw's unthread section. Therefore, please select a washer, spring washer, etc. to avoid unthread screw section from penetrating into output terminal inner section.

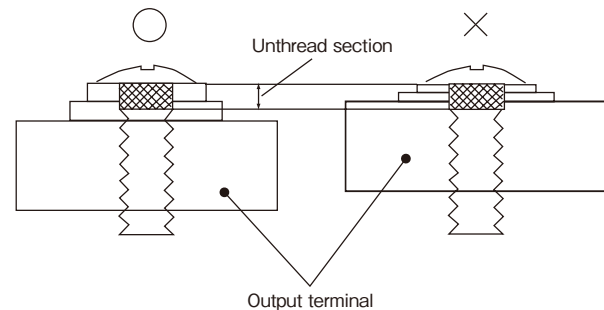

5. External Fuse Rating

Refer to the following fuse rating when selecting the external fuses for input line. Surge current flows when line turns on. Use slow-blow fuse or time-lag fuse. Do not use fast-blow fuse. Fuse rating is specified by in-rush current value

at line turn-on. Do not select the fuse according to input current (rms.) values under the actual load condition.

HWS1000:20A

6. Troubleshooting

Before concluding that the unit is at fault, make the following checks.

- (1) Check if the rated input voltage is apply.
- (2) Check if the wiring of input and output is correct.
- (3) Check if the I/O terminal connection is properly tight- en by a regulated tightening torque.
- (4) Check if the wire material is not too thin.
- (5) Check if the output voltage control (V.ADJ) is properly adjusted. OVP might be trigged and output is cut off.
- (6) Check if the wiring of "+S" and "-S" terminal is correct. If in open condition, the stability and the accuracy of the output deteriorate.
- (7) If use function of the remote ON/OFF control, check if the remote ON/OFF control connector is not opened. If in open condition, output is cut off.
- (8) Check if the built-in fan is not stopped. Is fan stopped by something irregulars or dust, etc. If fan stops, the PF signal is turn on.

Moreover, the output is intercepted with the protection circuit if fan stops.

Fans are the limited life parts.

- (9) This power supply has ventilating holes on the front and back panels. Check if there is any irregulars or dust, etc.
- (10) Is the main body of the power supply abnormally hot? Please turn on the input again after allowing the unit to cool down sufficiently. The output shut down by over temperature protection function.
- (11) Check if the output current and output power is not applied over specification.
- (12) Check if the input voltage wave is sinusoidal. If this power supply unit is connected to a UPS, input voltage wave might not be sinusoidal. An audible noise is emmited from the power supply unit.
- (13) Audible noise can be heard during Dynamic-Load operation.

7. Warranty

This product is warranted for a period of 5 years from the date of shipment. As for the breakdown under a normal use during free warranty term, repair is at free of charge. However, the Built-in Fan Motor replacement is for a fee. Please contact your nearest sales office for replacement.

The Fan-life has limitation. Therefore, periodic maintenance by replacing the life-expired fan is required. The following figure shows the life of fan.

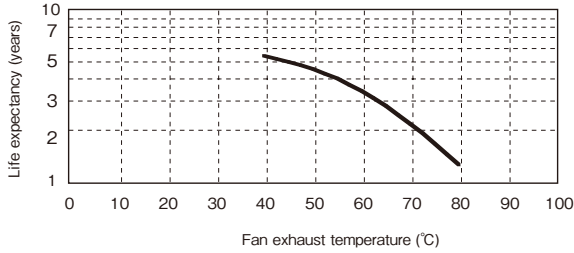

*Life expectancy

Fan exhaust temperature 45°C 45,000 hours
 Fan exhaust temperature 80°C 11,000 hours

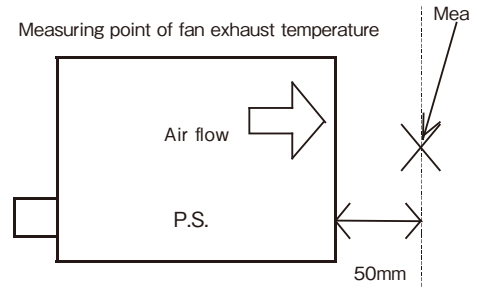

Conditions of usage at the free of charge warranty are as follows.

- (1) Average operating temperature (ambient temperature of the power supply unit) is 40°C
- (2) Average load factor is 80% or less
- (3) Installation method: Standard installation. However, the maximum rating is within the output derating.

Following cases are not covered by warranty.

- (1) Improper usage like dropping products, applying shock and defects from operation exceeding specification of the units.
- (2) Defects resulting from natural disaster (fire, flood).
- (3) Unauthorized modifications or repair by the buyers.
- (4) Defects not cause by TDK-Lambda.

8. Option

1 Fan unit for replacement

We have prepared an optional fan unit for replacement.

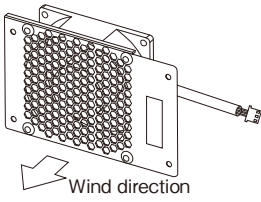
Name of fan unit for replacement	Applicable models	Appearance	Pin assignments	Price								
1500-FAN-01	HWS1000 HWS1500 HWS1800T (of standard specifications)		Housing = XHP-3 (J.S.T.) Contact = SXH-001T-P0.6 (J.S.T.) <table border="1"> <thead> <tr> <th>Pin No.</th> <th>Description</th> </tr> </thead> <tbody> <tr> <td>1</td> <td>Power supply</td> </tr> <tr> <td>2</td> <td>Fan alarm</td> </tr> <tr> <td>3</td> <td>GND</td> </tr> </tbody> </table> Length of fan harness = 65 ± 10mm	Pin No.	Description	1	Power supply	2	Fan alarm	3	GND	Open
Pin No.	Description											
1	Power supply											
2	Fan alarm											
3	GND											

Ask us for replacement of the fan. This will be a charged service. If you are replacing the fan by yourself, note the following.

- *1. Be careful in handling the fan unit so as not to cause an impact by dropping it or hitting it, etc.
- *2. Shut down the input before starting the replacement operation.
- *3. Check that there are no loose parts in connectors or harness tucking, etc.
- *4. Safety standards (UL, CE, etc.) are not applicable.

2 Insulation tube for HWS1000

The following insulation tube can be used for output terminal.
 • TCV-2001 (shinagawa shoko)
 Please confirm shape and size from manufacturer catalog.

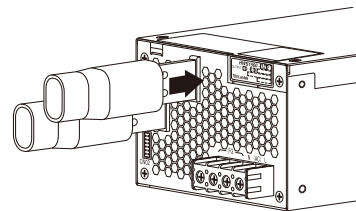

Example of use for insulation tube

HWS 1500 Series Instruction Manual

BEFORE USING THE POWER SUPPLY UNIT

Be sure to read the following precautions thoroughly before using this power supply unit.

Pay attention to all warnings and cautions before using the unit. Incorrect usage could lead to an electric shock, damage to the unit or a fire hazard.

⚠ WARNING

- Do not make unauthorized changes to power supply unit, otherwise you may have electric shock and void your warranty.
- Do not touch the internal components; they may have high voltage or high temperature. You may get electric shock or burned.
- When the unit is operating, keep your hands and face away from it; an accident may injure you.
- Do not use unit under unusual condition such as emission of smoke or abnormal smell and sound etc. It might cause fire and electric shock.
In such case, please contact us; do not repair by yourself, as it is dangerous for the user.
- Do not drop or insert anything into unit. It might cause failure and fire, when using the unit under such condition.
- Do not operate these units at the condition of condensation. It may cause fire and electric shock.
- Power supplies with an output voltage of 48Vdc or less must be earthed in the end use equipment to maintain SELV. If the outputs are not earthed, they must be considered hazardous and must not be made user accessible.
- Power supplies with an output voltage of 60Vdc are considered to be non-SELV. As a result of this, the output must be guarded or a deflector fitted during installation to avoid a SERVICE ENGINEER making inadvertent contact with the output terminals, or dropping a tool onto them. The output of this product must not be connected to a SELV circuit.

Note : CE MARKING

- CE Marking when applied to a product covered by this handbook indicates compliance with the low voltage directive (2006/95/EC) in that it complies with EN60950-1.

⚠ CAUTION

- This power supply is primarily designed and manufactured to use and enclose in other equipment.
- This power supply unit has a built-in fan for air-cooling. Do not block air intake and exhaust. It might cause fire.
- Input voltage, Output current, Output power, ambient temperature and ambient humidity should be used within specifications, otherwise the unit will be damaged.
- The unit might be broken down by accident or unexpected situation. For application equipment, which requires very high reliability (nuclear related equipment, traffic control equipment, medical equipment, etc.), please provide fail safety function in the equipment.
- Do not make an improper wiring to input and output terminals. It may cause damage.
- Do not use in environment such as strong electromagnetic field, erosive gas etc, or any environment where conductive foreign substance may enter.
- Do not operate and store this unit at the condition of condensation. In such case, waterproof treatment is necessary.
- Do not operate this unit after it falls down.
- The output voltage of this power supply unit is considered to be a hazardous energy level (The voltage is 2V or more and the electric power is 240VA or more), prevention from direct contact with voltage output is highly necessary. While installing or servicing this power supply unit, avoid dropping tools by mistake or direct contact with voltage output. This might cause an electric shock.
While repairing this power supply unit, the AC input power must be switch off and the I/O terminal voltage should be less than the safety level.

1. Terminal Explanation

Please pay extra attention to the wiring. Incorrect connection will damage the power supply.

- When connecting input and output wiring, input AC-Line should be off.
- Input wiring and output wiring shall be separated, otherwise noise susceptibility of power supply unit will be weak.

- The protective earth (PE) must be connected to the instrument chassis and the chassis of this power supply unit.
- Remote sensing lines shall be twisted or use the shielded wire.
- Remote ON/OFF control lines shall be twisted or use the shielded wire.

1 Front Panel Explanation

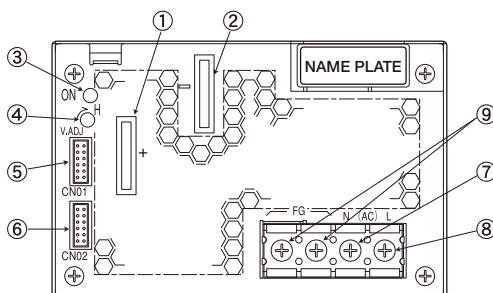

- ① + : + Output terminal
- ② - : - Output terminal
- ③ ON : Output (Power On) indication green LED
(The indicator turns on when the power supply output is in normal operating condition.)
- ④ V.ADJ : Output voltage adjust trimmer (The output voltage rises when trimmer is turned clockwise.)
- ⑤ CN01 : } Remote sensing, ON/OFF control signal, Current balance signal,
- ⑥ CN02 : } Output voltage external control signal and Power fail signal
output connector.
- ⑦ N : AC input terminal N : Neutral line
- ⑧ L : AC input terminal L : Live Line (Fuse in line)
- ⑨ FG : Function Ground terminal (Frame ground)

2 CN01, CN02 Connector pin configuration and Function

CN01, CN02 pin configuration and function are the same.

They are connected to each other in this power supply unit.

When the pin of CN01 side is shorted the same function pins of CN02 side are shorted.

Please note that the function cannot be separately set with CN01 and CN02.

Pin No.	Configuration	Function
1	+ V	Connected to + Output terminal in this Power supply unit. (+V terminal can not supply load current.)
2	+ S	Remote sensing terminal for + output (For remote sensing function, which compensates for line drop between power supply terminals and load terminals. Connect to +V terminal when remote sensing function is unnecessary)
3	- V	Connected to - Output terminal in this Power supply unit. (-V terminal can not supply load current)
4	- S	Remote sensing terminal for - output (For remote sensing function, which compensates for line drop between power supply terminals and load terminals. Connect to -V terminal when remote sensing function is unnecessary)
5	PC	Current balance terminal (For output current balancing in parallel operation.)
6	COM	Ground for PC and PV signal.
7	PV	Output voltage external control terminal (For power supply output voltage control with an external voltage. Connect it with the terminal REF when PV function is unnecessary.)
8	REF	Reference Voltage terminal for Output voltage control (REF and PV are connected when shipping.)
9	CNT	Remote ON/OFF control terminal (When the CNT is pulled to TTL low, the power supply turns on.)
10	TOG	Ground for CNT and PF signal.
11	PF	Power fail signal output terminal. (As the output voltage drops, FAN stops and AC input voltage down, open collector output, "Power Fail" signal will output "High".)
12	TOG	Ground for CNT and PF signal.

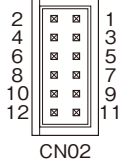
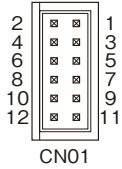

CN01, CN02 are connected in this power supply unit as follows.

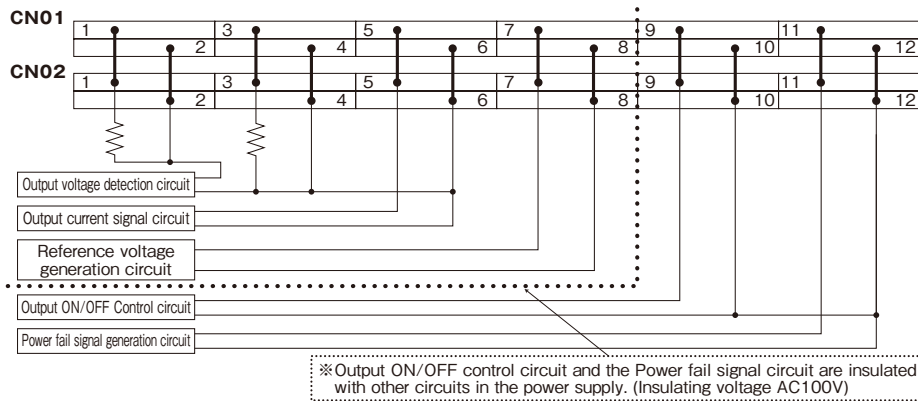

3 Basic Connection(Local sensing)

• 3-7V model

① Connect "+S" terminal to "+" terminal of output and "-S" terminal to "-" terminal of output with sensing wires.

② Connect "CNT" terminal to "TOG" terminal with wire.

③ Connect "PV" terminal to "REF" terminal with wire.

※ Please use attachment connector for each connection.

※ In the following cases, the output is shut down.

When CNT and TOG is opened.

When PV and REF is opened.

• 12-60V model

① Connect "+S" terminal to "+V" terminal and "-S" terminal to "-V" terminal with sensing wires.

② Connect "CNT" terminal to "TOG" terminal with wire.

③ Connect "PV" terminal to "REF" terminal with wire.

※ Please use attachment connector for each connection.

※ In the following cases, the output is shut down.

When CNT and TOG is opened.

When PV and REF is opened.

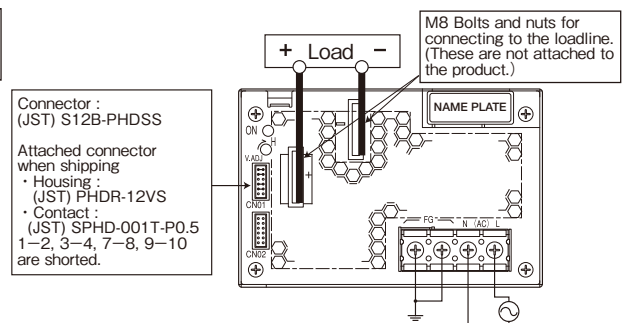
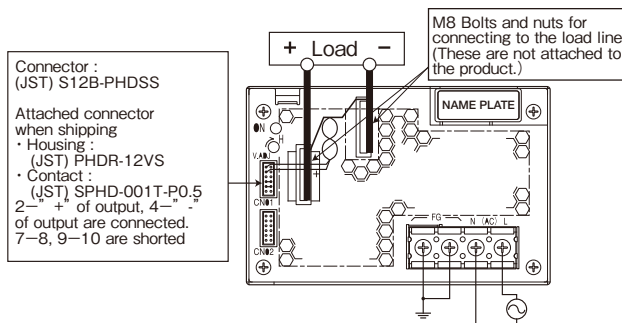

Attached connector when shipping

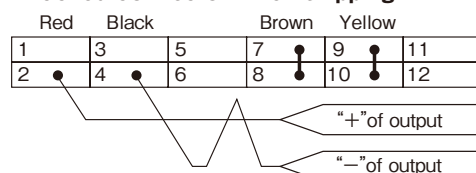

Attached connector when shipping

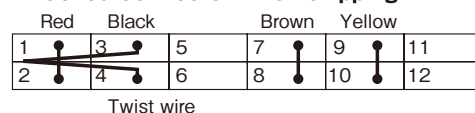

4 Remote sensing required

- ① Connect "+S" terminal to "+" terminal of load with sensing wire
 - ② Connect "-S" terminal to "-" terminal of load with sensing wires.
 - ③ Connect "CNT" terminal to "TOG" terminal with wire.
 - ④ Connect "PV" terminal to "REF" terminal with wire.
- ※ The accuracy of the output voltage will deteriorate when the sensing terminals are opened.
- ※ In the following cases, the output is shut down.
When CNT and TOG is opened.
When PV and REF is opened.

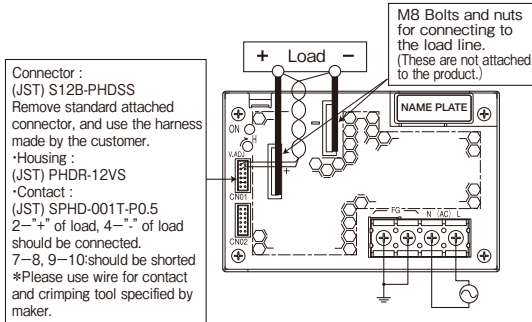

Connecting circuit with CN01 or CN02 connector

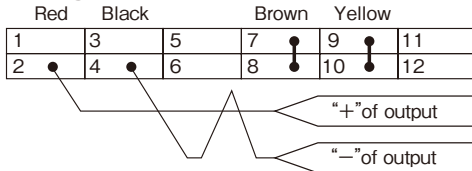

5 Remote ON/OFF control required

- ① Remove standard attached connector, and use the harness made by the customer and connect external signal to between CNT and TOG terminal.
 - ② "TOG" terminal is ground for "CNT" terminal.
- In case this function is not used, please short between CNT and TOG terminal.

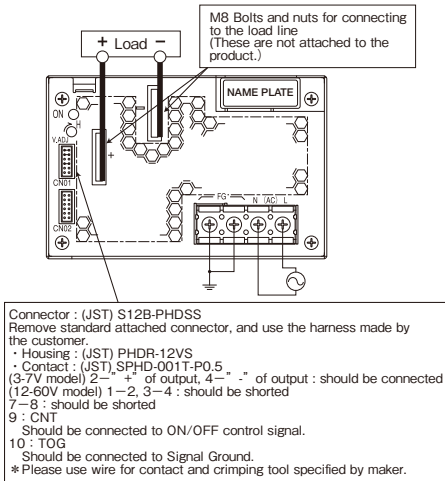

● Connecting circuit with CN01 or CN02 connector (3-7V model)

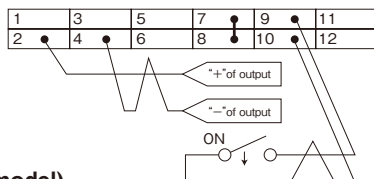

(12-60V model)

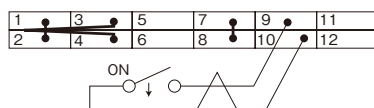

6 PF signal output required

- ① PF signal is an open collector output, therefore PF signal outputs is shown in circuit below.
- ② "TOG" terminal is ground for "PF" terminal.

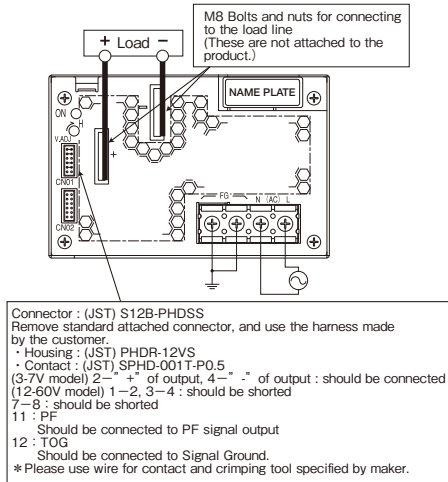

● Connecting circuit with CN01 or CN02 connector (3-7V model)

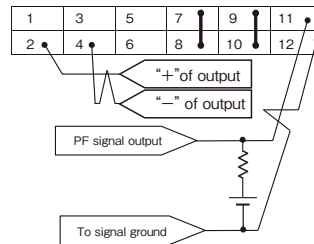

(12-60V model)

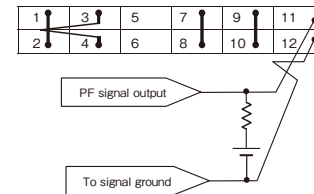

2. Functions and Precautions

1 Input Voltage Range

Input voltage range is single phase 85–265VAC (47–63Hz). Input voltage, which is out of specification, may cause unit damage. Rated input voltage range fix during safety standard application is from 100V to 240VAC (50/60Hz).

While applying input voltage from 85VAC to 90VAC, output load current derating is required.

2 Output Voltage Range

Output voltage is set to the rated value at shipping. V.ADJ trimmer on the front panel side is use to adjust the output voltage within the range specified. Output voltage trimming range is within -20% – +20% of the rated output voltage (48V, 60V Model: -20% – +10%). Turn the trimmer clockwise to increase output voltage. Take note when the output voltage is increased excessively over voltage protection (OVP) function may trigger and output voltage will shut down.

Use the output power of the power supply below the rated output power value when you raise the output voltage.

3 Over Voltage Protection (OVP)

The OVP function (Inverter shut down method, manual reset type) is provided. OVP function operates within 125-145% of the rated DC output voltage value (3-7V model: 125-140%, 36V type: 125-138%, 48V type: 115-135, 60V model: 115-125%), and the output will be shut down when OVP function triggers. When OVP function operates, the input power is cut off for a few minutes, and then power is re-input or remote ON/OFF control signal shall be input for recovery of the output. OVP value is fixed and can not be adjusted.

4 Over Current Protection (OCP)

The OCP function (Constant current limiting, Time delay shutdown type) is provided. OCP function operates when the output current exceeds 105% of maximum DC output current specification and the over current or short circuit condition continues 5-second or more, the output will be shut down. When the OCP is triggered, the input power is cut off for a few minutes, and then power is re-input or remote ON/OFF control signal should be input for recovery of the output. The OCP setting is fixed and not to be adjusted externally.

5 Over Temperature Protection (OTP)

Over temperature protection function (manual reset type) is provided. When ambient or internal temperature rises abnormally, OTP will shut down the output. When OTP is triggered, input power is cut off and allow sufficient cooling to reset the OTP function. Then power is re-input or remote ON/OFF control signal should be input for recovery of the output.

6 Low Output Detection Circuit (PF)

Low output voltage detection circuit is provided. Power Fail signal (PF signal) will output when output voltage decrease by either the drop or brown out of the input voltage or OCP, OVP and OTP function operation. PF signal will turn "High" level to indicate the abnormal status of the power supply when the output voltage decrease to 80% of the output voltage setting value. However, there is a possibility that PF signal may not output during parallel operation. The PF signal circuit is insulated from the power supply input and output circuit and it is an open collector. TOG terminal is ground for PF terminal.

When the Built-in Fan Motor of this power supply unit stops, PF signal will turn to "H" and the output power will shut down. The Built-in Fan Motor is a component with lifetime. We recommend a periodic replacement. Please contact our sales office. Replacement is at customer's expenses.

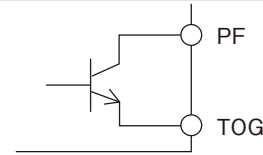

7 Remote Sensing (+S, -S terminal)

Remote sensing function is provided to compensate for voltage drop across the wiring from the power supply output terminals to the load input terminals. Connect "+S" terminal to "+" terminal of the load and "-S" terminal to "-" terminal of the load with sensing wires. The total line voltage drop (+ side line and - side line) shall be less than 0.3V. In case that sensing line is too long, it is necessary to put an electrolytic capacitor across the load terminals.

Please take note that the electrolytic capacitor has generation of heat etc. done by the ripple current depending on connected load. Therefore, the electrolytic capacitor must have a ripple current allowance higher than the output ripple current. If CN01 (or CN02) is in use, terminal +S, -S for CN02 (or CN01) must be in open condition.

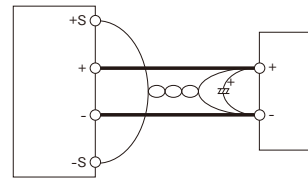

When the function of remote sensing is not in used, connect +S terminal to +V terminal, and -S terminal to -V terminal by the attachment connector.

If remote sensing terminals are opened, the stability and the accuracy of the output deteriorate. Therefore, terminal +S, -S must be connected.

8 Remote ON/OFF Control

Remote ON/OFF control is provided. Output can be remotely switch ON and OFF by using CNT terminal and TOG terminal even though input is connected. The output is turned to ON when TOG and CNT terminals are shorted and output is turned to OFF when these terminals are opened. When the function is not used, connect TOG and CNT terminals with short piece. The standards for this function are as follows. "TOG" terminal is ground for "CNT" terminal.

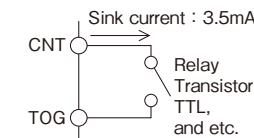

The Mode of control

CNT Level for TOG Terminal	Output	Built-in Fan Motor
Short or L (0–0.8V)	ON	Rotate
Open or H (2.4–12V)	OFF	Stop

- 1) TTL compatible. The maximum input voltage to CNT terminal is 12V, and the maximum allowable reverse voltage is -1V. The sink current of CNT terminal is 3.5mA.
- 2) Output ON/OFF control can be enable by a switch, relay or a transistor ON/OFF. When CNT terminal–TOG terminal is shorted power supply is turn ON, and when CNT terminal–TOG terminal is opened power supply is turn OFF.
- 3) Remote ON/OFF control circuit is isolated from the input and output circuit of power supply. It is possible to use it regardless of the positive and negative of the power supply output.

13 Withstand Voltage

This series is designed to withstand 3.0kVAC between input and output, 2.0kVAC between input and FG (chassis), 500VAC (60V model : 651VAC) between output and FG (chassis), and 100VAC between output and CNT·PF terminal each for 1 minute. When testing withstand voltage, set current limit of withstand voltage test equipment at 20mA.

(Output-FG (chassis) : 300mA (60V model : 390mA), Output- CNT·PF : 100mA).

The applied voltage must be gradually increased from zero to testing value and then gradually decreased for shut down. When timer is used, the power supply may be damaged by high impulse voltage at timer switch on and off. Connect input and output as follows. If output is left open during test, output voltage might appear momentarily.

This product have monolithic ceramic capacitor in secondary circuit to frame ground.

Some of the withstand voltage tester may generate high voltage at the matching with monolithic ceramic capacitor and may cause the unit damage.

So, please check the waveform of test voltage.

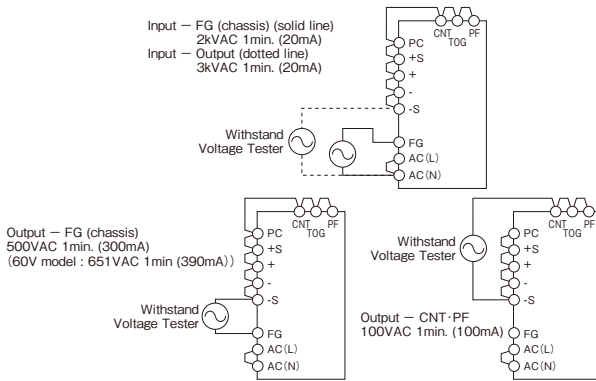

14 Output Voltage External Control (PV)

(A) Control by External Voltage

Output voltage external control function is provided. Output voltage can be varied by applying an external voltage (1-6V) to "PV" terminal and "COM" terminal. Note if an external voltage is not applied, there will be no output. Please consider the following characteristics below when operating the unit.

Connection Method

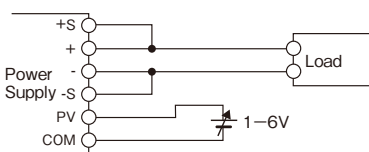

Output Voltage Linearity

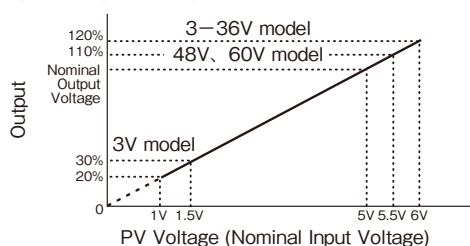

- Note: Only as for the model of 3V output, the output voltage is used from 30% to 120% at the PV voltage is from 1.5V to 6.0V
- Note: Only as for the model of 5-36V output, the output voltage is used from 20% to 120% at the PV voltage is from 1V to 6.0V
- Note: Only as for the model of 48V, 60V output, the output voltage is used from 20% to 110% at the PV voltage is from 1V to 5.5V

Output Voltage Derating

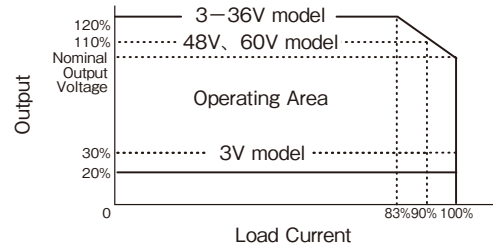

- Note: Only as for the model of 48V, 60V output, the maximum output voltage is used up to 110% at 90% load current.

(B) Control by External Variable Resistor

"PV" terminal and "COM" terminal usage is the same as explained in section [control by external voltage]. But in this method voltage for control is supplied through REF terminal. Variable resistor is connected between REF terminal and COM terminal and the middle point of variable resistor is connected to PV terminal. Please use the output voltage within 20% - 120% of rated output voltage value (3V model : 30% - 120%, 48V, 60V model : 20% - 110%). Wires for control lines must be twisted wire or shield wire. In addition, maximum variable voltage when control by external variable resistor is rated output voltage (100%). When output voltage must be externally control to 120% of rated output voltage (110% for 48V, 60V model), please follow the following procedure.

- (1) PV terminal and REF terminal is short by using standard connector supplied.
- (2) Set the power supply output voltage to maximum value of the output voltage variable range mentioned in specification standard by adjusting V.ADJ volume at the front panel.
- (3) Remove standard connector after input is cut off.
- (4) Connect external variable resistor (50kΩ) between REF terminal and COM terminal. Then connect middle point of external variable resistor to PV terminal. (sensing current is 1.4mA)

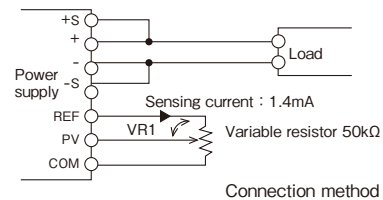

When output voltage is over rated value, please make sure that maximum output power is below rated value. Moreover, when output voltage is below rated value, please make sure that maximum output current is below rated value.

Please consider the following characteristic during usage.

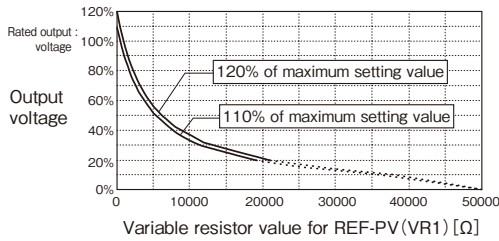

* Adjustable output voltage within 20% (3Vmodel : 30%) of output (less than 1V of PV voltage) is proportional to PV voltage and has a linear characteristic. However, for output voltage within 10% of output (about less than 0.5V of PV voltage), output will go into intermittent mode and ripple voltage becomes large, also irregular sound is release from the power supply. However, it is not damage. There will also be cases of the power supply shutting down triggered by under voltage lock out protection function. With output shutting down, low output detection function (PF) triggers the PF signal and set it to "H", and also output LED is switch off. Under voltage lock out protection mode, switch off input for a few minutes and then switch on input again for recovery. Recovery from under voltage lock out is also possible by turning remote ON/OFF control signal OFF and ON. Under voltage detection value uses an automatic tracking mode, which follows the output voltage and constantly correspond to the 70%-80% of output voltage with a protection function mode. Base on the explanation above, we will kindly exclude the usage of adjustable output voltage within 20% of the output voltage from the product warranty. For application that requires variable output voltage within 20% of output voltage, please kindly consider the above contents prior to operation. For application that requires output voltage below 20%, due to different type of application for the user's system, there might be a situation (behavior) different from the one mentioned above. Therefore please check with the user system.

15 Output Peak Current

For model with output peak current, please meet the following condition.Reduce peak current value according to output derating as section 4-1.

The output is shut down by protection circuit when rated current and continuous peak output time (τ) exceeds rated value during usage.

When protection circuit is activated, input is temporarily cut off for a few minutes and then power is re-input or remote ON/OFF control signal should be input for recovery of the output.

Input voltage range : AC180V - 265V
 Continuous Peak output time. (τ) : Within 10 seconds
 Peak output current (Ip) : Within the rated peak output current
 Duty : up to 35%
 Duty = $\frac{\tau}{T} \times 100$ (%)

Condition 1

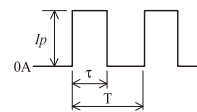

Model	Irms max
HWS1500-6	177.5A
HWS1500-7	142.0A
HWS1500-24	62.1A
HWS1500-36	41.4A
HWS1500-60	24.8A

$$N \sqrt{I_p^2 \times \frac{\tau}{T}} \leq I_{rms \max}$$

Condition 2

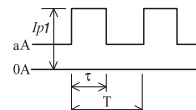

$$N \left(I_{p1}^2 \times \frac{\tau}{T} + a^2 \times \left(1 - \frac{\tau}{T} \right) \right) \leq I_{rms \max}$$

Ip, Ip1 : Peak output current (A)
 Irms : Effective current (A)
 τ : Peak current pulse width (sec)
 T : cycle (sec)

3. Mounting Directions

1 Output Derating

Mounting directions are as follows. Standard mounting method is (A). Methods (B), (C) and (D) are also possible. Mounting methods besides (A), (B), (C) and (D) (example: (E) and (F)) are inhibit.

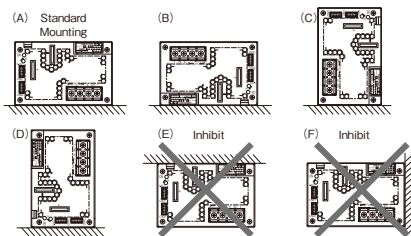

2 Mounting Method Caution

- (1) This Power supply unit is a forced air-cooling system with a built-in fan.
- (2) This power supply has ventilating holes on the front and back panels. Keep these areas freely more than 100mm from front side and more than 50mm from rear side.
- (3) Please note that ventilation will be worsened in a dusty environment.
- (4) Built-in fan is limited life part, which require periodic replacement. (Replacement will be charge).
- (5) The ambient temperature of this power supply is less than 50mm from the center of a front side.

HWS1500 Output Derating

3, 5V Ta(°C)	6-60V Ta(°C)	LOAD (%)			
		A	B	C	D
-10 - +40	-10 - +50	100	100	100	100
70	70	50	50	50	50

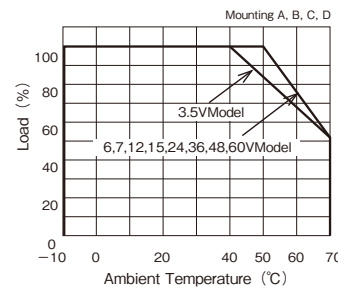

- (6) The maximum allowable penetration of mounting screw is 6mm.
- (7) Recommended torque for mounting screw (M4) is 1.27N · m.

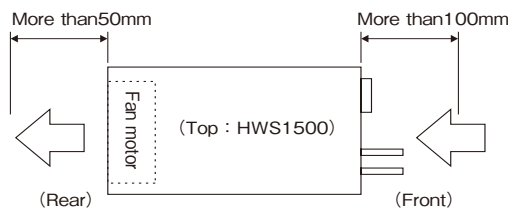

4. Wiring Method

- (1) The output load line and input line shall be separated and twisted to improve noise sensitivity.
- (2) The sensing lines shall be twisted or shield wire and separated from the output lines.
- (3) Use all lines as thick and short as possible to make lower impedance. Wires are to be twisted or use shield wire to improve noise sensitivity.
- (4) Attaching a capacitor to the load terminals can eliminate noise.
- (5) FG terminal of this power supply is functional earthing.
For safety purposes, connect protective earthing terminal to the mounting set ground terminal.
- (6) Recommended torque for the terminal piece:

Input terminal (M4 screw) : 1.27 N·m
Output terminal (M8 Bolt & Nut) : 10.8N·m

- (7) Recommended wiring

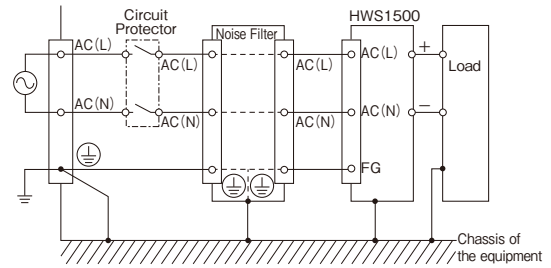

- (8) M4 screw for output terminal might damage the terminal's inner thread. This is mainly cause by the M4 screw's unthread section. Therefore, please select a washer, spring washer, etc. to avoid unthread screw section from penetrating into output terminal inner section.

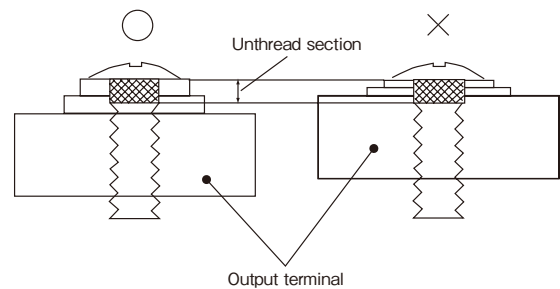

5. External Fuse Rating

Refer to the following fuse rating when selecting the external fuses for input line. Surge current flows when line turns on. Use slow-blow fuse or time-lag fuse. Do not use fast-blow fuse. Fuse rating is specified by in-rush current value at line turn-on. Do not select the fuse according to input current (rms.) values under

the actual load condition.
HWS1500 : 30A

6. Troubleshooting

Before concluding that the unit is at fault, make the following checks.

- (1) Check if the rated input voltage is apply.
- (2) Check if the wiring of input and output is correct.
- (3) Check if the I/O terminal connection is properly tighten by a regulated tightening torque.
- (4) Check if the wire material is not too thin.
- (5) Check if the output voltage control (V.ADJ) is properly adjusted. OVP might be trigged and output is cut off.
- (6) Check if the wiring of "+S" and "-S" terminal is correct.
If in open condition, the stability and the accuracy of the output deteriorate.
- (7) If use function of the remote ON/OFF control, check if the remote ON/OFF control connector is not opened.
If in open condition, output is cut off.

- (8) Check if the built-in fan is not stopped. Is fan stopped by something irregulars or dust, etc.
If fan stops, the PF signal is turn on.
Moreover, the output is intercepted with the protection circuit if fan stops.
Fans are the limited life parts.
- (9) This power supply has ventilating holes on the front and back panels. Check if there is any irregulars or dust, etc.
- (10) Is the main body of the power supply abnormally hot?
Please turn on the input again after allowing the unit to cool down sufficiently. The output shut down by over temperature protection function.
- (11) Check if the output current and output power is not applied over specification.
- (12) Check if the input voltage wave is sinusoidal. If this power supply unit is connected to a UPS, input voltage wave might not be sinusoidal. An audible noise is emmitted from the power supply unit.
- (13) Audible noise can be heard during Dynamic-Load operation.

7. Warranty

This product is warranted for a period of 5 years from the date of shipment. As for the breakdown under a normal use during free warranty term, repair is at free of charge. However, the Built-in Fan Motor replacement is for a fee. Please contact your nearest sales office for replacement. The Fan-life has limitation. Therefore, periodic maintenance by replacing the life-expired fan is required. The following figure shows the life of fan.

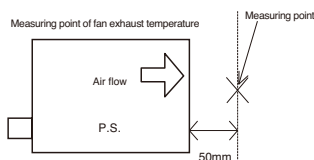
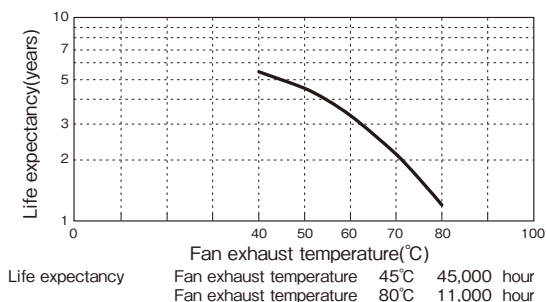

Conditions of usage at the free of charge warranty are as follows.

- (1) Average operating temperature (ambient temperature of the power supply unit) is 40°C
- (2) Average load factor is 80% or less
- (3) Installation method: Standard installation. However, the maximum rating is within the output derating.

Following cases are not covered by warranty.

- (1) Improper usage like dropping products, applying shock and defects from operation exceeding specification of the units.
- (2) Defects resulting from natural disaster (fire, flood).
- (3) Unauthorized modifications or repair by the buyers.
- (4) Defects not cause by TDK-Lambda.

8. Option

1 Fan unit for replacement

We have prepared an optional fan unit for replacement.

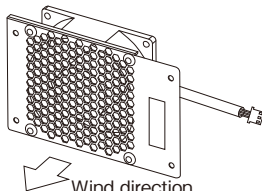
Name of fan unit for replacement	Applicable models	Appearance	Pin assignments	Price								
1500-FAN-01	HWS1000 HWS1500 HWS1800T (of standard specifications)		Housing = XHP-3(J.S.T.) Contact = SXH-001T-P0.6(J.S.T.) <table border="1" style="margin-left: 20px;"> <thead> <tr> <th>Pin No.</th> <th>Description</th> </tr> </thead> <tbody> <tr> <td>1</td> <td>Power supply</td> </tr> <tr> <td>2</td> <td>Fan alarm</td> </tr> <tr> <td>3</td> <td>GND</td> </tr> </tbody> </table> Length of fan harness = 65 ± 10mm	Pin No.	Description	1	Power supply	2	Fan alarm	3	GND	Open
Pin No.	Description											
1	Power supply											
2	Fan alarm											
3	GND											

Ask us for replacement of the fan. This will be a charged service. If you are replacing the fan by yourself, note the following.

- *1. Be careful in handling the fan unit so as not to cause an impact by dropping it or hitting it, etc.
- *2. Shut down the input before starting the replacement operation.
- *3. Check that there are no loose parts in connectors or harness tucking, etc.
- *4. Safety standards (UL, CE, etc.) are not applicable.

2 Insulation tube for HWS1500

The following insulation tube can be used for output terminal.
 •TCV-2001 (shinagawa shoko)
 Please confirm shape and size from manufacturer catalog.

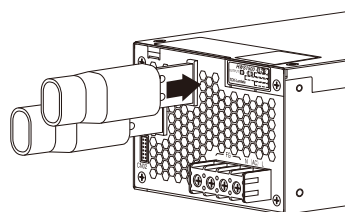

Example of use for insulation tube

HWS 1800T Series Instruction Manual

BEFORE USING THE POWER SUPPLY UNIT

Be sure to read the following precautions thoroughly before using this power supply unit.

Pay attention to all warnings and cautions before using the unit. Incorrect usage could lead to an electrical shock, damage to the unit or a fire hazard.

⚠ WARNING

- Do not make unauthorized changes to power supply unit, otherwise you may have electric shock and void your warranty.
- Do not touch the internal components; they may have high voltage or high temperature. You may get electrical shock or burned.
- When the unit is operating, keep your hands and face away from it; an accident may injure you.
- Do not use unit under unusual condition such as emission of smoke or abnormal smell and sound etc. It might cause fire and electric shock.
In such case, please contact us; do not repair by yourself, as it is dangerous for the user.
- Do not drop or insert anything into unit. It might cause failure and fire, when using the unit under such condition.
- Do not operate these units at the condition of condensation. It may cause fire and electric shock.
- Power supplies with an output voltage of 48Vdc or less must be earthed in the end use equipment to maintain SELV. If the outputs are not earthed, they must be considered hazardous and must not be made user accessible.
- Power supplies with an output voltage of 60Vdc are considered to be non-SELV. As a result of this, the output must be guarded or a deflector fitted during installation to avoid a SERVICE ENGINEER making inadvertent contact with the output terminals, or dropping a tool onto them. The output of this product must not be connected to a SELV circuit.

Note : CE MARKING

- CE Marking when applied to a product covered by this handbook indicates compliance with the low voltage directive (2006/95/EC) in that it complies with EN60950-1.

⚠ CAUTION

- This power supply is primarily designed and manufactured to use and enclose in other equipment.
- This power supply unit has a built-in fan for air-cooling. Do not block air intake and exhaust. It might cause fire.
- Input voltage, Output current, Output power, ambient temperature and ambient humidity should be used within specifications, otherwise the unit will be damaged.
- The unit might be broken down by accident or unexpected situation. For application equipment, which requires very high reliability (nuclear related equipment, traffic control equipment, medical equipment, etc.), please provide fail safety function in the equipment.
- Do not make an improper wiring to input and output terminals. It may cause damage.
- Do not use in environment such as strong electromagnetic field, erosive gas etc, or any environment where conductive foreign substance may enter.
- Do not operate and store this unit at the condition of condensation. In such case, waterproof treatment is necessary.
- Do not operate this unit after it falls down.
- The output voltage of this power supply unit is considered to be a hazardous energy level (The voltage is 2V or more and the electric power is 240VA or more), prevention from direct contact with voltage output is highly necessary. While installing or servicing this power supply unit, avoid dropping tools by mistake or direct contact with voltage output. This might cause an electrical shock.
While repairing this power supply unit, the AC input power must be switch off and the I/O terminal voltage should be less than the safety level.

1. Terminal Explanation

Please pay extra attention to the wiring. Incorrect connection will damage the power supply.

- When connecting input and output wiring, input AC-Line should be off.
- Input wiring and output wiring shall be separated, otherwise noise susceptibility of power supply unit will be weak.

- The protective earth (PE) must be connected to the instrument chassis and the chassis of this power supply unit.
- Remote sensing lines shall be twisted or use the shielded wire.
- Remote ON/OFF control lines shall be twisted or use the shielded wire.

1 Front Panel Explanation

HWS1800T Front Panel

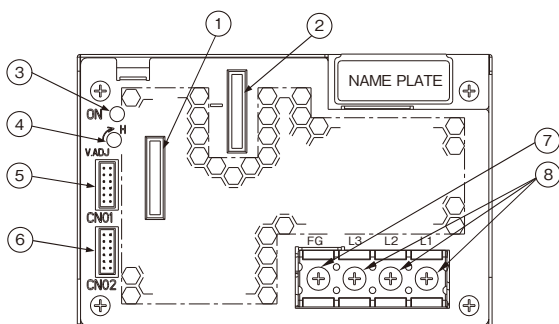

- ① + : + Output terminal
- ② - : - Output terminal
- ③ ON : Output (Power On) indication green LED
(The indicator turns on when the power supply output is in normal operating condition.)
- ④ V.ADJ : Output voltage adjust trimmer
(The output voltage rises when trimmer is turned clockwise.)
- ⑤ CN01 : } Remote sensing, ON/OFF control signal, Current balance signal,
- ⑥ CN02 : } Output voltage external control signal and Power fail signal output connector.
- ⑦ FG : Function Ground terminal (Frame ground)
- ⑧ L1,L2,L3 : Three phase AC input terminal (Fuse in each line)

• All specifications are subject to change without notice.

HWS
HWS HD
HWS ME
HWS-P
Instruction Manual

2 CN01, CN02 Connector pin configuration and function

CN01, CN02 pin configuration and function are the same.

They are connected to each other in this power supply unit.

When the pin of CN01 side is shorted the same function pins of CN02 side are shorted.

Please note that the function cannot be separately set with CN01 and CN02.

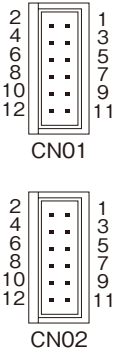
	Pin No.	Configuration	Function
	1	+V	Connected to +Output terminal in this Power supply unit. (+V terminal can not supply load current.)
	2	+S	Remote sensing terminal for + output (For remote sensing function, which compensates for line drop between power supply terminals and load terminals. Connect to +V terminal when remote sensing function is unnecessary)
	3	-V	Connected to -Output terminal in this Power supply unit. (-V terminal can not supply load current)
	4	-S	Remote sensing terminal for - output (For remote sensing function, which compensates for line drop between power supply terminals and load terminals. Connect to -V terminal when remote sensing function is unnecessary)
	5	PC	Current balance terminal (For output current balancing in parallel operation.)
	6	COM	Ground for PC and PV signal.
	7	PV	Output voltage external control terminal (For power supply output voltage control with an external voltage. Connect it with the terminal REF when PV function is unnecessary.)
	8	REF	Reference Voltage terminal for Output voltage control (REF and PV are connected when shipping.)
	9	CNT	Remote ON/OFF control terminal (When the CNT is pulled to TTL low, the power supply turns on.)
	10	TOG	Ground for CNT and PF signal.
	11	PF	Power fail signal output terminal. (As the output voltage drops, FAN stops and AC input voltage down, open collector output, "Power Fail" signal will output "High" .)
	12	TOG	Ground for CNT and PF signal.

CN01, CN02 are connected in this power supply unit as follows.

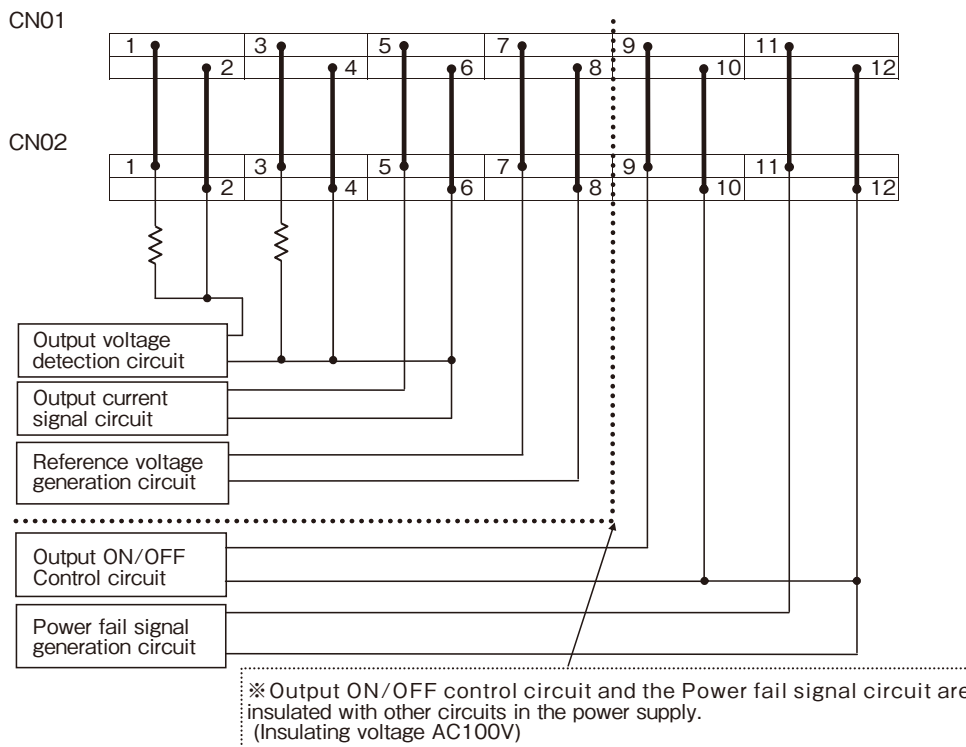

3 Basic Connection (Local sensing)

• 3-7V model

- ① Connect "+S" terminal to "+" terminal of output and "-S" terminal to "-" terminal of output with sensing wires.
 - ② Connect "CNT" terminal to "TOG" terminal with wire.
 - ③ Connect "PV" terminal to "REF" terminal with wire.
- ※ Please use attachment connector for each connection.
 ※ In the following cases, the output is shut down.

When CNT and TOG is opened:
 When PV and REF is opened:

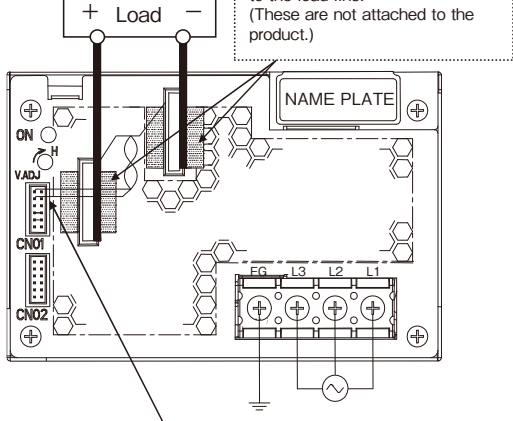

Connector : (JST) S12B-PHDSS
 Attached connector when shipping
 ·Housing : (JST) PHDR-12VS
 ·Contact : (JST) SPHD-001T-P0.5
 2-"+" of output, 4-"-" of output are connected.
 7-8, 9-10 are shorted

Attached connector when shipping

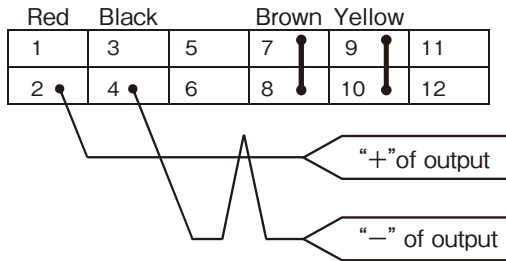

• 12-60V model

- ① Connect "+S" terminal to "+V" terminal and "-S" terminal to "-V" terminal with sensing wires.
 - ② Connect "CNT" terminal to "TOG" terminal with wire.
 - ③ Connect "PV" terminal to "REF" terminal with wire.
- ※ Please use attachment connector for each connection.
 ※ In the following cases, the output is shut down.
- When CNT and TOG is opened.
 When PV and REF is opened.

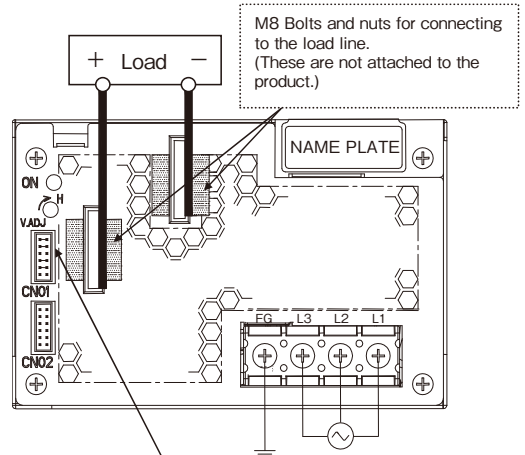

Connector : (JST) S12B-PHDSS
 Attached connector when shipping
 ·Housing : (JST) PHDR-12VS
 ·Contact : (JST) SPHD-001T-P0.5
 1-2, 3-4, 7-8, 9-10 are shorted.

Attached connector when shipping

Red	Black	Brown	Yellow
1	3	5	7
2	4	6	8
			9
			10
			11
			12

Twist wire

4 Remote sensing required

- ① Connect "+S" terminal to "+" terminal of load with sensing wire
 - ② Connect "-S" terminal to "-" terminal of load with sensing wires.
 - ③ Connect "CNT" terminal to "TOG" terminal with wire.
 - ④ Connect "PV" terminal to "REF" terminal with wire.
- ※ The accuracy of the output voltage will deteriorate when the sensing terminals are opened.
 ※ In the following cases, the output is shut down.
 When CNT and TOG is opened.
 When PV and REF is opened.

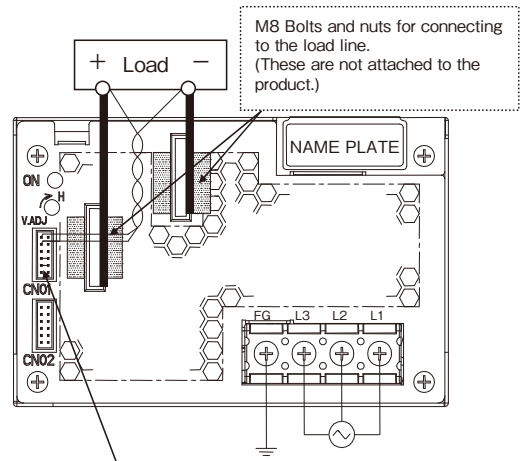

Connector : (JST) S12B-PHDSS
 Remove standard attached connector, and use the harness made by the customer.
 ·Housing : (JST) PHDR-12VS
 ·Contact : (JST) SPHD-001T-P0.5
 2-"+" of load, 4-"-" of load should be connected.
 7-8, 9-10 : should be shorted
 * Please use wire for contact and crimping tool specified by maker.

Connecting circuit with CN01 or CN02 connector

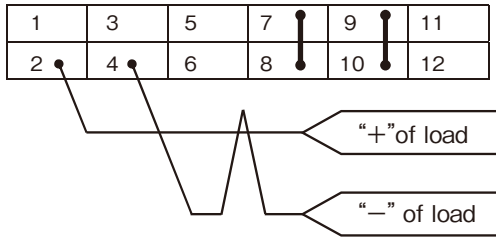

5 Remote ON/OFF control required

- ① Remove standard attached connector, and use the harness made by the customer and connect external signal to between CNT and TOG terminal.
- ② "TOG" terminal is ground for "CNT" terminal. In case this function is not used, please short between CNT and TOG terminal.

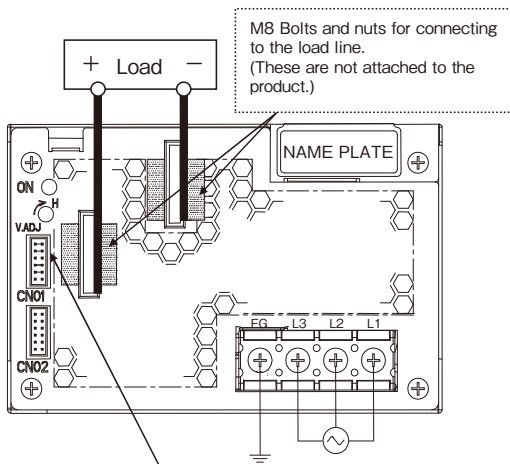

Connector : (JST) S12B-PHDSS

Remove standard attached connector, and use the harness made by the customer.

- Housing : (JST) PHDR-12VS
- Contact : (JST) SPHD-001T-P0.5

(3-7V model) 2-"+" of output, 4-"-" of output : should be connected
 (12-60V model) 1-2, 3-4 : should be shorted
 7-8 : should be shorted
 9 : CNT
 Should be connected to ON/OFF control signal.
 10 : TOG
 Should be connected to Signal Ground.
 * Please use wire for contact and crimping tool specified by maker.

Connecting circuit with CN01 or CN02 connector

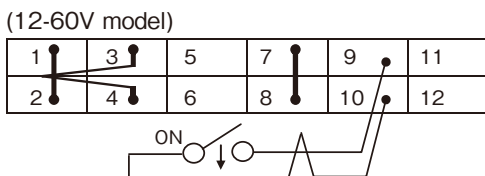
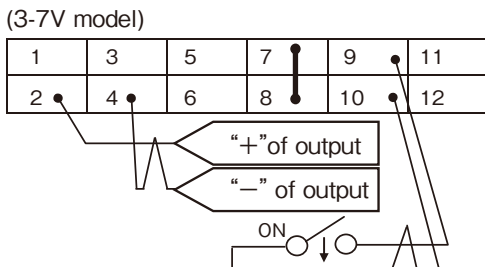

6 PF signal output required

- ① PF signal is an open collector output, therefore PF signal outputs is shown in circuit below.
- ② "TOG" terminal is ground for "PF" terminal.

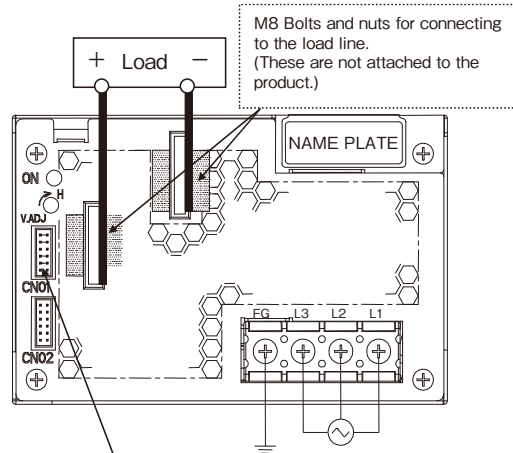

Connector : (JST) S12B-PHDSS

Remove standard attached connector, and use the harness made by the customer.

- Housing : (JST) PHDR-12VS
- Contact : (JST) SPHD-001T-P0.5

(3-7V model) 2-"+" of output, 4-"-" of output : should be connected
 (12-60V model) 1-2, 3-4 : should be shorted
 7-8, 9-10 : should be shorted.
 11 : PF
 Should be connected to PF signal output
 12 : TOG
 Should be connected to Signal Ground.
 * Please use wire for contact and crimping tool specified by maker.

Connecting circuit with CN01 or CN02 connector (3-7V model)

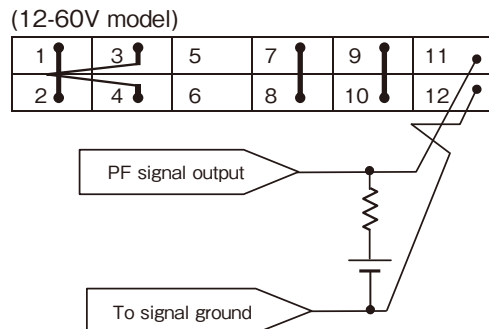
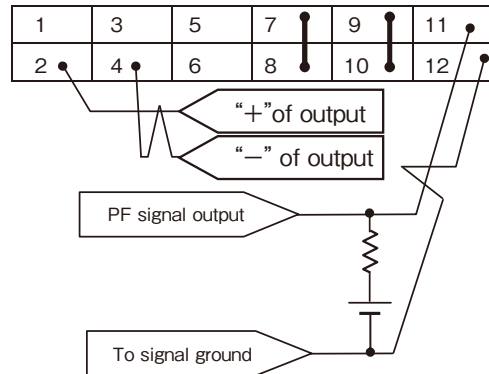

2. Functions and Precautions

1 Input Voltage Range

Input voltage range is three phase 170–265VAC(47–63Hz). Input voltage, which is out of specification, may cause unit damage. Rated input voltage range fix during safety standard application is from 200V to 240VAC (50/60Hz).

2 Output Voltage Range

Output voltage is set to the rated value at shipping. V.ADJ trimmer on the front panel side is use to adjust the output voltage within the range specified. Output voltage trimming range is within -20% – +20% of the rated output voltage (48V, 60V model: -20% – +10%). Turn the trimmer clockwise to increase output voltage. Take note when the output voltage is increased excessively over voltage protection (OVP) function may trigger and output voltage will shut down.

Use the output power of the power supply below the rated output power value when you raise the output voltage.

3 Over Voltage Protection (OVP)

The OVP function (Inverter shut down method, manual reset type) is provided. OVP function operates within 125-145% of the rated DC output voltage value (3-7V model: 125-140%, 36V model: 125-138%, 48V, 60V model: 115-125%), and the output will be shut down when OVP function triggers. When OVP function operates, the input power is cut off for a few minutes, and then power is re-input or remote ON/OFF control signal shall be input for recovery of the output. OVP value is fixed and can not be adjusted.

4 Over Current Protection (OCP)

The OCP function (Constant current limiting, Time delay shutdown type) is provided. OCP function operates when the output current exceeds 105% of maximum DC output current specification and the over current or short circuit condition continues 5-second or more, the output will be shut down. When the OCP is triggered, the input power is cut off for a few minutes, and then power is re-input or remote ON/OFF control signal should be input for recovery of the output. The OCP setting is fixed and not to be adjusted externally.

5 Over Temperature Protection (OTP)

Over temperature protection function (manual reset type) is provided. When ambient or internal temperature rises abnormally, OTP will shut down the output. When OTP is triggered, input power is cut off and allow sufficient cooling to reset the OTP function. Then power is re-input or remote ON/OFF control signal should be input for recovery of the output.

6 Low Output Detection Circuit (PF)

Low output voltage detection circuit is provided. Power Fail signal (PF signal) will output when output voltage decrease by either the drop or brown out of the input voltage or OCP, OVP and OTP function operation. PF signal will turn "High" level to indicate the abnormal status

of the power supply when the output voltage decrease to 80% of the output voltage setting value. However, there is a possibility that PF signal may not output during parallel operation. The PF signal circuit is insulated from the power supply input and output circuit and it is an open collector. TOG terminal is ground for PF terminal.

When the Built-in Fan Motor of this power supply unit stops, PF signal will turn to "H" and the output power will shut down. The Built-in Fan Motor is a component with lifetime. We recommend a periodic replacement. Please contact our sales office. Replacement is at customer's expenses.

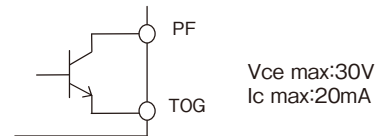

7 Remote Sensing (+S, -S terminal)

Remote sensing function is provided to compensate for voltage drop across the wiring from the power supply output terminals to the load input terminals. Connect "+S" terminal to "+" terminal of the load and "-S" terminal to "-" terminal of the load with sensing wires. The total line voltage drop (+ side line and - side line) shall be less than 0.3V. In case that sensing line is too long, it is necessary to put an electrolytic capacitor across the load terminals.

Please take note that the electrolytic capacitor has generation of heat etc. done by the ripple current depending on connected load. Therefore, the electrolytic capacitor must have a ripple current allowance higher than the output ripple current. If CN01 (or CN02) is in use, terminal +S, -S for CN02 (or CN01) must be in open condition.

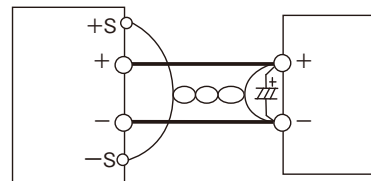

When the function of remote sensing is not in used, connect +S terminal to +V terminal, and -S terminal to -V terminal by the attachment connector.

If remote sensing terminals are opened, the stability and the accuracy of the output deteriorate. Therefore, terminal +S, -S must be connected.

8 Remote ON/OFF Control

Remote ON/OFF control is provided. Output can be remotely switch ON and OFF by using CNT terminal and TOG terminal even though input is connected. The output is turned to ON when TOG and CNT terminals are shorted and output is turned to OFF when these terminals are opened. When the function is not used, connect TOG and CNT terminals with short piece. The standards for this function are as follows. "TOG" terminal is ground for "CNT" terminal.

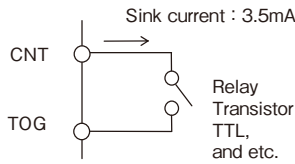

The Mode of control

CNT Level for TOG Terminal	Output	Built-in Fan Motor
Short or L (0-0.8V)	ON	Rotate
Open or H (2.4-12V)	OFF	Stop

- 1) TTL compatible. The maximum input voltage to CNT terminal is 12V, and the maximum allowable reverse voltage is -1V. The sink current of CNT terminal is 3.5mA.
- 2) Output ON/OFF control can be enable by a switch, relay or a transistor ON/OFF. When CNT terminal-TOG terminal is shorted power supply is turn ON, and when CNT terminal-TOG terminal is opened power supply is turn OFF.
- 3) Remote ON/OFF control circuit is isolated from the input and output circuit of power supply.
It is possible to use it regardless of the positive and negative of the power supply output.

Please be aware that if CNT terminal and TOG terminal is short and input voltage is gradually increase, this will trigger the low output voltage detector protection circuit and will result to output voltage shut down. When the low output voltage detector protection circuit is triggered, the input power is cut off for a few minutes, and then power is re-input or remote ON/OFF control signal should be input for recovery of the output.

9 Output Ripple & Noise

Maximum ripple & noise value in specifications is measured according to measurement circuit specified by JEITA-RC9131A. When Load lines are longer, ripple & noise becomes larger. In this case, electrolytic capacitor, film capacitor, etc. might be necessary to use across the load terminal. The output ripple & noise cannot be measured accurately if the probe ground lead of oscilloscope is too long.

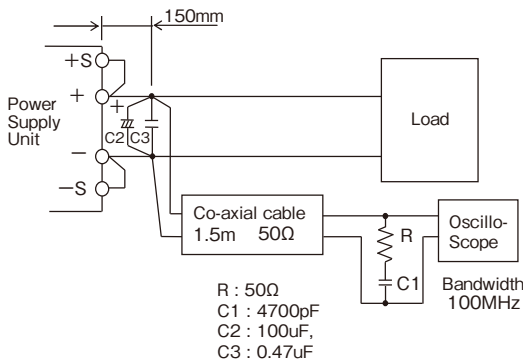

10 Series Operation

For series operation, either method (A) or (B) is possible. There might be a step in the rise waveform during series operation.

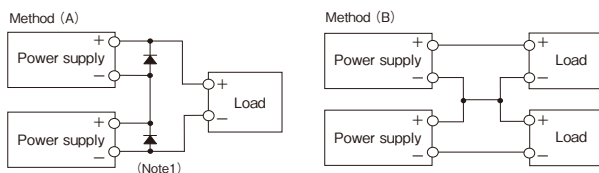

(Note1) Please connect a diode for by-pass when using method (A) of the series operation. Please use the diode with rated forward current is equal or more than load current and that the rated maximum reverse voltage is higher than output voltage for each power supply.

11 Parallel Operation

Current balancing function is provided. Either of operations mode (A) or (B) is possible.

(A) To Increase the Output Current

Current balancing function activates by connecting PC-to-PC terminal and COM-to-COM terminal, and output current of each power supply is equivalently supplied to load. Wires to PC terminals shall be as short as possible, same length and twisted. There is a possibility that output could be unstable caused by external noise. For this case, disconnect COM terminal and connect -S terminal from parallel power supply to a single point on the load. Please refer connection Method (A)-2.

- 1) Adjust the output voltage of each power supply to be same value within 1% or 100mV, whichever is smaller.
- 2) Use same length and type of wires for all load lines.
- 3) Maximum value of output current in parallel is up to 80% of all paralleled models. The purpose of the current balancing function is the static power-up. Therefore the output voltage might decrease according to the condition of dynamic load. There might be a step in the rise waveform during parallel operation.
- 4) Up to 5 units can be connected in parallel.

(B) To Use as a Backup Power Supply

- 1) Set power supply output voltage higher by the forward voltage drop of diode.
- 2) Adjust the output voltage of each power supply to be same value.
- 3) Use within the specifications for output voltage and output power.

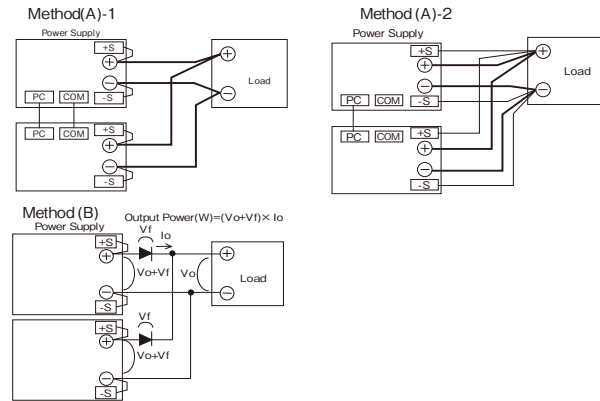

12 Isolation Test

Isolation resistance between output and FG (chassis) shall be more than 100Ω at 500VDC and between output and CNT·PF shall be more than 10MΩ at 100VDC. For safety operation, voltage setting of DC isolation tester must be done before the test. Ensure that it is fully discharged after the test.

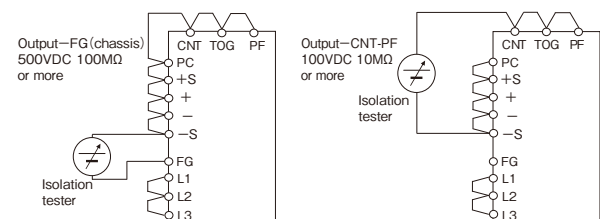

13 Withstand Voltage

This series is designed to withstand 3.0kVAC between input and output, 2.0kVAC between input and FG (chassis), 500VAC (60V model: 651VAC) between output and FG (chassis), and 100VAC between output and CNT·PF terminal each for 1 minute. When testing withstand voltage, set current limit of withstand voltage test equipment at 20mA.

(Output-FG (chassis): 300mA (60V model: 390mA), Output- CNT·PF : 100mA).

The applied voltage must be gradually increased from zero to testing value and then gradually decreased for shut down. When timer is used, the power supply may be damaged by high impulse voltage at timer switch on and off. Connect input and output as follows. If output is left open during test, output voltage might appear momentarily.

This product have monolithic ceramic capacitor in secondary circuit to frame ground.

Some of the withstand voltage tester may generate high voltage at the matching with monolithic ceramic capacitor and may cause the unit damage.

So, please check the waveform of test voltage.

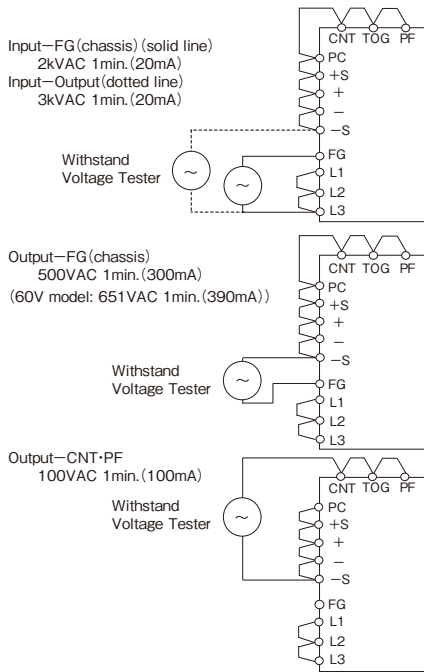

14 Output Voltage External Control (PV)

(A) Control by External Voltage

Output voltage external control function is provided. Output voltage can be varied by applying an external voltage (1-6V) to "PV" terminal and "COM" terminal. Note if an external voltage is not applied, there will be no output. Please consider the following characteristics below when operating the unit.

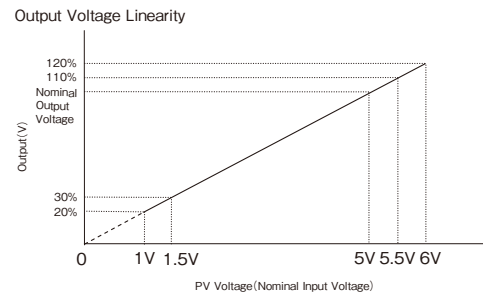
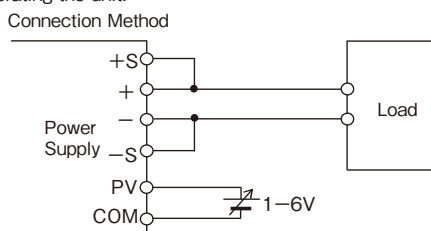

Note: Only as for the model of 3V output, the output voltage is used from 30% to 120% at the PV voltage is from 1.5V to 6V

Note: Only as for the model of 5-36V output, the output voltage is used from 20% to 120% at the PV voltage is from 1V to 6V

Note: Only as for the model of 48V, 60V output, the output voltage is used from 20% to 110% at the PV voltage is from 1V to 5.5V

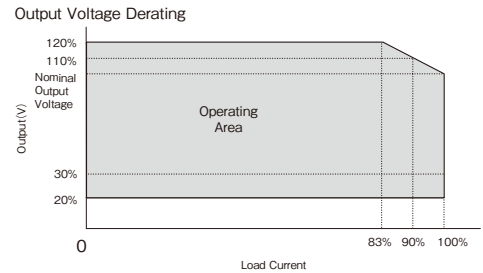

Note: Only as for the model of 48V, 60V output, the maximum output voltage is used up to 110% at 90% load current.

(B) Control by External Variable Resistor

"PV" terminal and "COM" terminal usage is the same as explained in section [control by external voltage] . But in this method voltage for control is supplied through REF terminal. Variable resistor is connected between REF terminal and COM terminal and the middle point of variable resistor is connected to PV terminal. Please use the output voltage within 20% - 120% of rated output voltage value (48V, 60V model: 20% - 110%). Wires for control lines must be twisted wire or shield wire. In addition, maximum variable voltage when control by external variable resistor is rated output voltage (100%). When output voltage must be externally control to 120% of rated output voltage (110% for 48V, 60V model), please follow the following procedure.

- (1) PV terminal and REF terminal is short by using standard connector supplied.
- (2) Set the power supply output voltage to maximum value of the output voltage variable range mentioned in specification standard by adjusting V.ADJ volume at the front panel.
- (3) Remove standard connector after input is cut off.
- (4) Connect external variable resistor (50kΩ) between REF terminal and COM terminal. Then connect middle point of external variable resistor to PV terminal.(sensing current is 1.4mA)

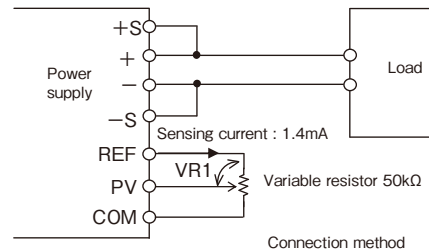

When output voltage is over rated value, please make sure that maximum output power is below rated value. Moreover, when output voltage is below rated value, please make sure that maximum output current is below rated value.

Please consider the following characteristic during usage.

Please consider the following characteristic during usage.

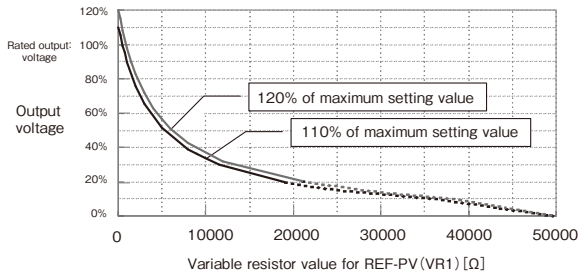

* Adjustable output voltage within 20%(3Vmodel : 30%) of output (less than 1V of PV voltage) is proportional to PV voltage and has a linear characteristic. However, for output voltage within 10% of output (about less than 0.5V of PV voltage), output will go into intermittent mode and ripple voltage becomes large, also irregular sound is release from the power supply. However, it is not damage. There will also be cases of the power supply shutting down triggered by under voltage lock out protection function. With output shutting down, low output detection function (PF) triggers the PF signal and set it to "H", and also output LED is switch off. Under voltage lock out protection mode, switch off input for a few minutes and then switch on input again for recovery. Recovery from under voltage lock out is also possible by turning remote ON/OFF control signal OFF and ON. Under voltage detection value uses an automatic tracking mode, which follows the output voltage and constantly correspond to the 70%-80% of output voltage with a protection function mode. Base on the explanation above, we will kindly exclude the usage of adjustable output voltage within 20% of the output voltage from the product warranty. For application that requires variable output voltage within 20% of output voltage, please kindly consider the above contents prior to operation. For application that requires output voltage below 20%, due to different type of application for the user's system, there might be a situation (behavior) different from the one mentioned above. Therefore please check with the user system.

15 Output Peak Current

For model with output peak current, please meet the following condition.

Reduce peak current value according to output derating as section 4-1.

The output is shut down by protection circuit when rated current and continuous peak output time (τ) exceeds rated value during usage.

When protection circuit is activated, input is temporarily cut off for a few minutes and then power is re-input or remote ON/OFF control signal should be input for recovery of the output.

- Continuous Peak output time. (τ) : Within 10 seconds
- Peak output current (Ip) : Within the rated peak output current
- Duty : up to 35%

$$\text{Duty} = \frac{\tau}{T} \times 100(\%)$$

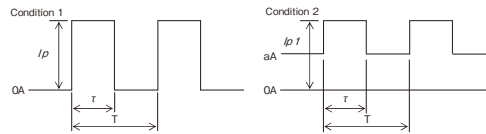

$$\sqrt{Ip^2 \times \frac{\tau}{T}} \leq I_{rms \max} \quad \sqrt{Ip1^2 \times \frac{\tau}{T} + a^2 \times (1 - \frac{\tau}{T})} \leq I_{rms \max}$$

Model	I _{rms max}
HWS1800T-6	177.5A
HWS1800T-7	142.0A
HWS1800T-12	88.7A
HWS1800T-15	71.0A
HWS1800T-24	62.1A
HWS1800T-36	41.4A
HWS1800T-48	31.0A
HWS1800T-60	24.8A

- Ip, Ip1 : Peak output current (A)
- I_{av} : Rated output current (A)
- I_m : Average output current (A)
- τ : Peak current pulse width(sec)
- T : cycle(sec)

16 Input Open Phase Detection

If one of the 3-phase input line becomes open or one phase voltage falls below 160VAC, the output will be shut off in approximately 3 seconds. To restore the output to normal, shut off the input once, and apply a normal input line voltage again after for a while.

3. Mounting Directions

1 Output Derating

Mounting directions are as follows.
 Standard mounting method is (A). Methods (B), (C) and (D) are also possible.
 Mounting methods besides (A),(B),(C) and (D) (example : (E) and (F)) are inhibit.

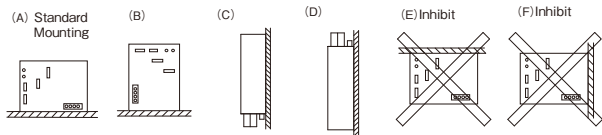

HWS1800T 3V Output Derating

Ta (°C)	LOAD (W)			
	A	B	C	D
-10 - +40	990	990	990	990
50	825	825	825	825
60	660	660	660	660
71	495	495	495	495

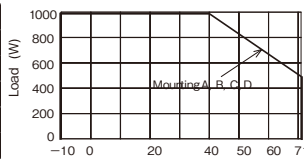

HWS1800T 5V Output Derating

Ta (°C)	LOAD (W)			
	A	B	C	D
-10 - +40	1500	1500	1500	1500
50	1250	1250	1250	1250
60	1000	1000	1000	1000
71	750	750	750	750

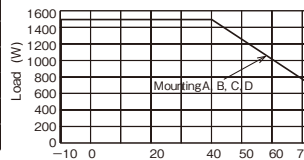

HWS1800T 6V-15V Output Derating

Ta (°C)	LOAD (W)			
	A	B	C	D
-10 - +40	1500	1500	1500	1500
50	1500	1500	1500	1500
60	1125	1125	1125	1125
71	750	750	750	750

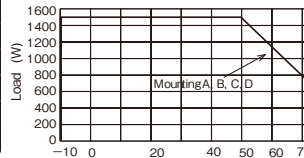

HWS1800T 24V-60V Output Derating

Ta (°C)	LOAD (W)			
	A	B	C	D
-10 - +40	1800	1800	1800	1800
50	1680	1680	1680	1680
60	1300	1300	1300	1300
71	900	900	900	900

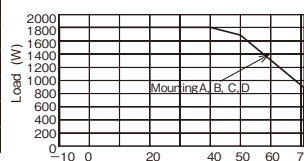

2 Mounting Method Caution

- (1) This Power supply unit is a forced air-cooling system with a built-in fan.
- (2) This power supply has ventilating holes on the front and back panels.
 Keep these areas freely more than 100mm from front side and more than 50mm from rear side.
- (3) Please note that ventilation will be worsened in a dusty environment.
- (4) Built-in fan is limited life part, which require periodic replacement. (Replacement will be charge).
- (5) The ambient temperature of this power supply is less than 50mm from the center of a front side.
- (6) The maximum allowable penetration of mounting screw is 6mm.
- (7) Recommended torque for mounting screw (M4) is 1.27N · m.

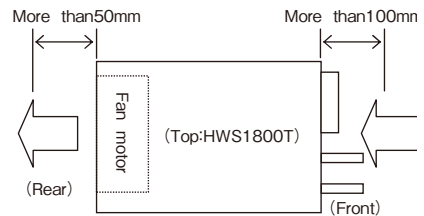

4. Wiring Method

- (1) The output load line and input line shall be separated and twisted to improve noise sensitivity.
- (2) The sensing lines shall be twisted or shield wire and separated from the output lines.
- (3) Use all lines as thick and short as possible to make lower impedance. Wires are to be twisted or use shield wire to improve noise sensitivity.
- (4) Attaching a capacitor to the load terminals can eliminate noise.
- (5) FG terminal of this power supply is functional earthing. For safety purposes, connect protective earthing terminal to the mounting set ground terminal.
- (6) Recommended torque for the terminal piece:

Input terminal (M4 screw) : 1.27 N·m Output terminal (M8 Bolt & Nut) : 10.8N·m

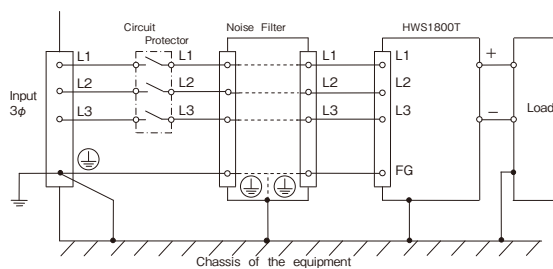

- (8) M4 screw for output terminal might damage the terminal's inner thread. This is mainly caused by the M4 screw's unthread section. Therefore, please select a washer, spring washer, etc. to avoid unthread screw section from penetrating into output terminal inner section.

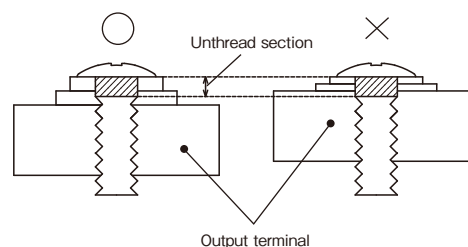

- (7) Recommended wiring

5. External Fuse Rating

Refer to the following fuse rating when selecting the external fuses for input line. Surge current flows when line turns on. Use slow-blow fuse or time-lag fuse. Do not use fast-blow fuse. Fuse rating is specified by in-rush current value at line turn-on. Do not select the fuse according to input

current (rms.) values under the actual load condition.
HWS1800T : 20A

6. Troubleshooting

Before concluding that the unit is at fault, make the following checks.

- (1) Check if the rated input voltage is apply.
- (2) Check if the wiring of input and output is correct.
- (3) Check if the I/O terminal connection is properly tighten by a regulated tightening torque.
- (4) Check if the wire material is not too thin.
- (5) Check if the output voltage control (V.ADJ) is properly adjusted. OVP might be trigged and output is cut off.
- (6) Check if the wiring of "+S" and "-S" terminal is correct. If in open condition, the stability and the accuracy of the output deteriorate.
- (7) If use function of the remote ON/OFF control, check if the remote ON/OFF control connector is not opened. If in open condition, output is cut off.
- (8) Check if the built-in fan is not stopped. Is fan stopped by something irregulars or dust, etc. If fan stops, the PF signal is turn on. Moreover, the output is intercepted with the protection

circuit if fan stops.

Fans are the limited life parts.

- (9) This power supply has ventilating holes on the front and back panels. Check if there is any irregulars or dust, etc.
- (10) Is the main body of the power supply abnormally hot? Please turn on the input again after allowing the unit to cool down sufficiently. The output shut down by over temperature protection function.
- (11) Check if the output current and output power is not applied over specification.
- (12) Check if the input voltage wave is sinusoidal. If this power supply unit is connected to a UPS, input voltage wave might not be sinusoidal. An audible noise is emitted from the power supply unit.
- (13) Audible noise can be heard during Dynamic-Load operation.

7. Warranty

This product is warranted for a period of 5 years from the date of shipment. As for the breakdown under a normal use during free warrantee term, repair is at free of charge. However, the Built-in Fan Motor replacement is for a fee. Please contact your nearest sales office for replacement. The Fan-life has limitation. Therefore, periodic maintenance by replacing the life-expired fan is required. The following figure shows the life of fan.

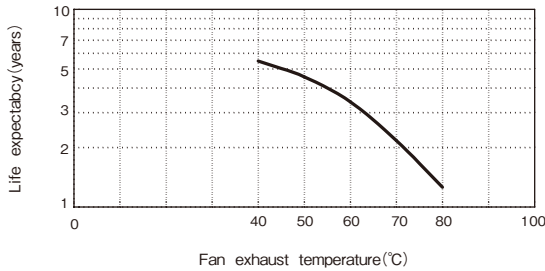

Life expectancy

Fan exhaust temperature	45°C	45,000 hour
Fan exhaust temperature	80°C	11,000 hour

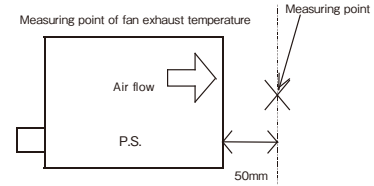

Conditions of usage at the free of charge warrantee are as follows.

- (1) Average operating temperature (ambient temperature of the power supply unit) is 40°C
- (2) Average load factor is 80% or less
- (3) Installation method: Standard installation. However, the maximum rating is within the output derating.

Following cases are not covered by warranty.

- (1) Improper usage like dropping products, applying shock and defects from operation exceeding specification of the units.
- (2) Defects resulting from natural disaster (fire, flood).
- (3) Unauthorized modifications or repair by the buyers.
- (4) Defects not cause by TDK-Lambda.

8. Option

1 Fan unit for replacement

We have prepared an optional fan unit for replacement.

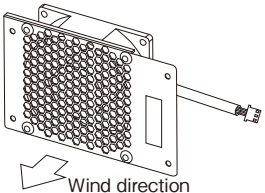
Name of fan unit for replacement	Applicable models	Appearance	Pin assignments	Price								
1500-FAN-01	HWS1000 HWS1500 HWS1800T (of standard specifications)		Housing = XHP-3(J.S.T.) Contact = SXH-001T-P0.6(J.S.T.) <table border="1" style="margin-left: auto; margin-right: auto;"> <thead> <tr> <th style="font-size: small;">Pin No.</th> <th style="font-size: small;">Description</th> </tr> </thead> <tbody> <tr> <td style="text-align: center;">1</td> <td>Power supply</td> </tr> <tr> <td style="text-align: center;">2</td> <td>Fan alarm</td> </tr> <tr> <td style="text-align: center;">3</td> <td>GND</td> </tr> </tbody> </table> Length of fan harness = 65 ± 10mm	Pin No.	Description	1	Power supply	2	Fan alarm	3	GND	Open
Pin No.	Description											
1	Power supply											
2	Fan alarm											
3	GND											

Ask us for replacement of the fan. This will be a charged service. If you are replacing the fan by yourself, note the following.

- *1. Be careful in handling the fan unit so as not to cause an impact by dropping it or hitting it, etc.
- *2. Shut down the input before starting the replacement operation.
- *3. Check that there are no loose parts in connectors or harness tucking, etc.
- *4. Safety standards (UL, CE, etc.) are not applicable.

2 Insulation tube for HWS1800T

The following insulation tube can be used for output terminal.

•TCV-2001 (shinagawa shoko)

Please confirm shape and size from manufacturer catalog.

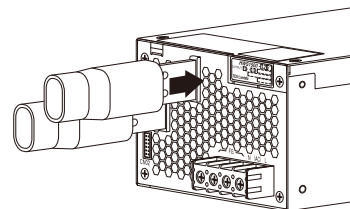

Example of use for insulation tube

TDK-Lambda

HWS-P

Single Output 300W ~ 600W



■ Features

- Single output pulse power type in wide range input power supply.
- Up to 3 times peak current.
- Full Load (100%) Capability at 50°C operating temperature

■ Model naming method

HWS 300P – 24

Series name

Nominal output voltage
ex. 24: 24V, 36: 36V, 48: 48V

Output Power
ex. 300P: 300W, 600P: 600W

■ Applications



■ Conformity to RoHS Directive

This means that, in conformity with EU Directive 2002/95/EC, lead, cadmium, mercury, hexavalent chromium, and specific bromine-based flame retardants, PBB and PBDE, have not been used, except for exempted applications.

■ Product Line up

Output Voltage	HWS300P				HWS600P		
	Ave. Output Current	Peak Output Current		Ave. Output Current	Peak Output Current		
		100V in	200V in		100V in	200V in	
24V	12.5A	21.0A	42.0A	25.0A	40.5A	83.0A	
36V	8.4A	14.0A	28.0A	16.7A	27.0A	55.5A	
48V	6.3A	10.5A	21.0A	12.5A	20.0A	41.5A	

(*)(100Vin/200Vin)

HWS300P Specifications

ITEMS/UNITS		MODEL	HWS300P-24	HWS300P-36	HWS300P-48
Input	Voltage Range (*3)	V	85 - 265VAC or 120 - 330VDC		
	Frequency	Hz	47 - 63		
	Power Factor (100/200VAC)(Typ) (*2)		0.99/0.93		
	Efficiency (100VAC)(Typ) (*2)	%	84		
	Efficiency (200VAC)(Typ) (*2)	%	87		
	Current (100/200VAC)(Typ) (*2)	A	3.6/1.9		
	Inrush Current (100/200VAC)(Typ) (*4)	A	20 / 40		
Leakage Current (*11)	mA	Less than 0.75mA. (0.2(Typ) at 100VAC / 0.44(Typ) at 230VAC)			
Output	Nominal Voltage	VDC	24	36	48
	Average Current	A	12.5	8.4	6.3
	Maximum Peak Current (100VAC/200VAC) (*1)	A	21/42	14/28	10.5/21
	Average Power	W	300	302.4	
	Maximum Peak Power (100VAC) (*1)	W	504		
	Maximum Peak Power (200VAC) (*1)	W	1008		
	Maximum Line Regulation (*6)	mV	96	144	192
	Maximum Load Regulation (*7)	mV	144	216	288
	Temperature Coefficient		Less than 0.02% / ° C		
	Maximum Ripple & Noise (0≤Ta≤70° C) (*5)	mVp-p	150	200	350
	Maximum Ripple & Noise (-10≤Ta<0° C) (*5)	mVp-p	200	250	400
	Hold-up Time (Typ) (*10)	ms	20ms		
	Voltage Adjustable Range	VDC	19.2 - 26.4	28.8 - 39.6	38.4 - 52.8
	Function	Over Current Protection (100VAC) (*8)	A	>21.4	>14.3
Over Current Protection (200VAC) (*8)		A	>42.8	>28.6	>21.4
Over Voltage Protection (*9)		VDC	27.6 - 32.4	41.4 - 48.6	55.2 - 64.8
Remote Sensing			-		
Remote ON/OFF Control			Possible		
Parallel Operation			-		
Series Operation			Possible		
Monitoring Signal			PF(Open Collector Output)		
Line DIP			Designed to meet SEMI-F47 (200VAC Line only)		
Environment		Operating Temperature (*12)	°C	-10 - +70(-10 - +50:100%,+70:50%)	
	Storage Temperature	°C	-30 - +85		
	Operating Humidity	%RH	10 - 90 (No dewdrop)		
	Storage Humidity	%RH	10 - 95 (No dewdrop)		
	Vibration		At no operating, 10 - 55Hz (Sweep for 1min) 19.6m/s ² Constant, X,Y,Z 1hour each		
	Shock (In package)		Less than 196.1m/s ²		
	Cooling		Forced Air By Blower Fan		
Isolation	Withstand Voltage		Input - FG : 2.5kVAC (20mA), Input - Output : 3kVAC (20mA) Output - FG: 500VAC (100mA), Output-CNT: 100VAC(100mA) for 1min		
	Isolation Resistance		More than 100MΩ Output - FG : 500VDC More than 10MΩ Output - CNT : 100VDC at 25° C and 70%RH		
Standards	Safety Standards (*13)		Approved by UL60950-1, CSA60950-1, EN60950-1, EN50178 Designed to meet DENAN		
	PFHC		Designed to meet IEC61000-3-2		
	EMI (*14)		Designed to meet EN55011/EN55022-B, FCC-B, VCCI-B		
Mechanical	Immunity		Designed to meet IEC61000-4-2(Level 2,3), -3(Level 3), -4(Level 3), -5(Level 3,4), -6(Level 3), -8(Level 4), -11		
	Weight (Typ)	g	1000		
	Size (W×H×D)	mm	61 x 82 x 165 (Refer to Outline Drawing)		

*Read instruction manual carefully, before using the power supply unit.

=NOTES=

- (*1) Operating time at peak output is less than 5sec, duty is less than 35%. For details, refer to peak output condition.
When the peak output more than 5 sec is continued, the output is shut down, manual reset (CNT reset or Re power on).
- (*2) At 100/200VAC, Ta=25°C and average output power.
- (*3) For cases where conformance to various safety specs (UL, CSA, EN) are required, to be described as 100 - 240VAC(50/60Hz).
- (*4) First inrush current. Not applicable for the inrush current to Noise Filter for less than 0.2ms.
- (*5) Measure with JEITA RC-9131A probe, Bandwidth of scope :100MHz. At average output power.
- (*6) 85 - 265VAC , constant load.
- (*7) No load-Average load, constant input voltage.
- (*8) OCP circuit will shut the output down, manual reset (CNT reset or Re power on).
- (*9) OVP circuit will shut the output down, manual reset (CNT reset or Re power on).
- (*10) At 100/200VAC , nominal output voltage and average output current.
- (*11) Measured by the each measuring method of UL,CSA,EN and DENAN(at 60Hz), Ta=25°C.
- (*12) Ratings - Derating at standard mounting. Refer to output derating curve.
- Load (%) is percent of average output power or average output current, whichever is greater.
- (*13) As for DENAN, designed to meet at 100VAC.
- (*14) At Ta=25° C and average output power.

Outline Drawing

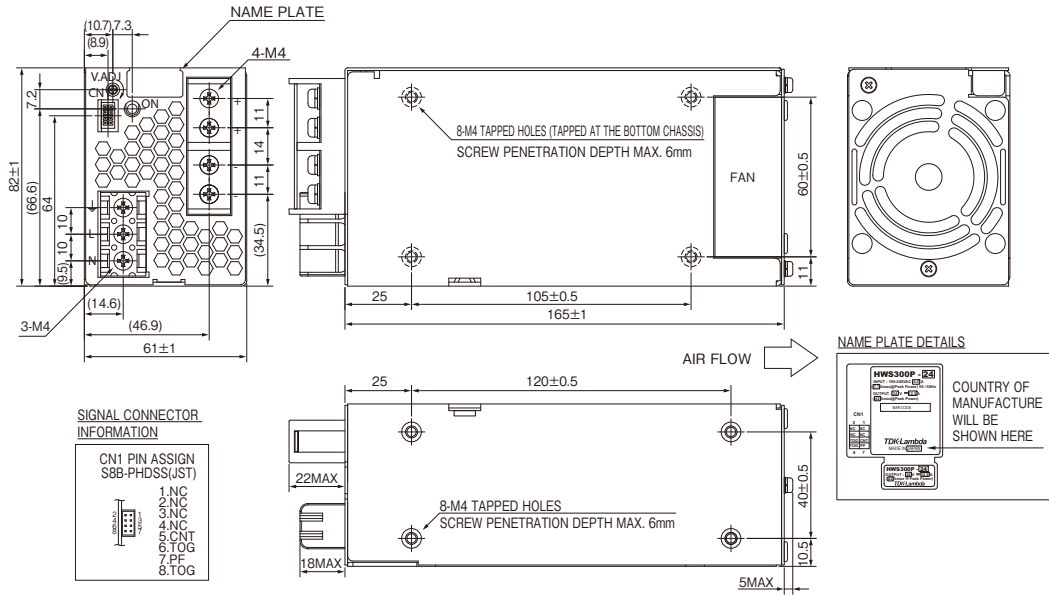

SIGNAL CONNECTOR USED

PART DESCRIPTION	PART NAME	MANUFACT
PIN HEADER	S8B-PHDS	J.S.T.

MATCHING HOUSINGS , PINS & TOOL

PART DESCRIPTION	PART NAME	MANUFACT
SOCKET HOUSING	PHDR-08VS	J.S.T.
TERMINAL PINS	SPHD-002T-P0.5(AWG28 24) SPHD-001T-P0.5(AWG26 22)	J.S.T.
HAND CRIMPING TOOL	YRS-620(SPHD-002T-P0.5) YC-610R(SPHD-001T-P0.5)	J.S.T.

Output Derating

Ta (°C)	LOAD(%)	
	MOUNTING A	MOUNTING B
-10~+50	100	
70	50	

- (*1) Load(%) is percent of average output power or average output current.
For example, load 100% refers to following condition when output is 24V model.
24[V], 12.5[A]
- (*2) Peak output current does not need derating.

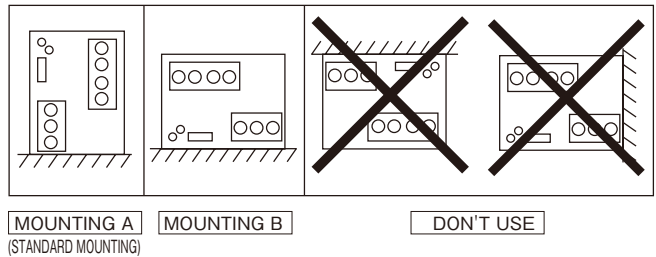
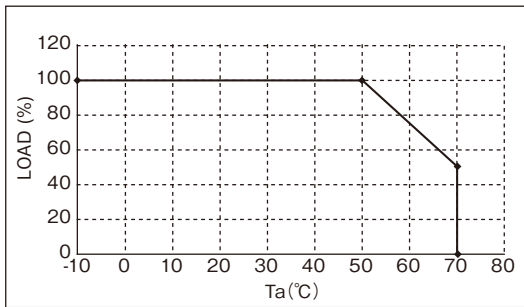

Peak Output Condition

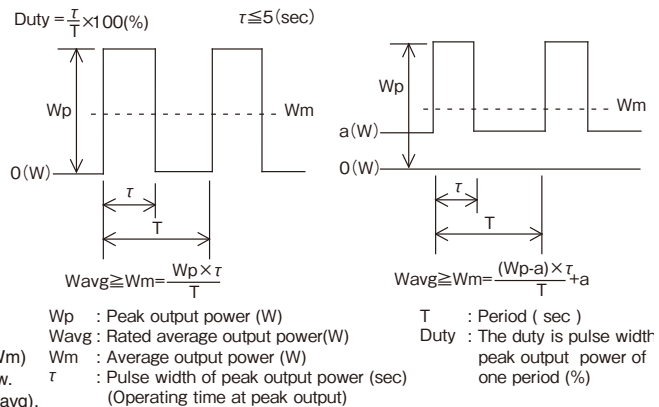
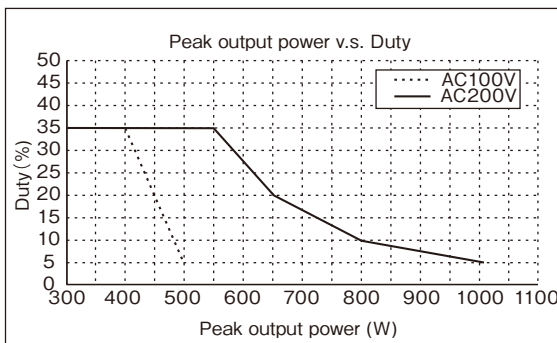

Use this product so that relationship among Duty, average output power (Wm) and peak output power (Wp) satisfy conditions defined by expression below.
 This product must be used less than average output power of specification (Wavg).
 Also operating duration at peak output power should be less than 5 sec.

• All specifications are subject to change without notice.

HWS600P Specifications

ITEMS/UNITS		MODEL	HWS600P-24	HWS600P-36	HWS600P-48
Input	Voltage Range (*3)	V	85 - 265VAC or 120 - 330VDC		
	Frequency	Hz	47 - 63		
	Power Factor (100/200VAC)(Typ) (*2)		0.99/0.94		
	Efficiency (100VAC)(Typ) (*2)	%	84		
	Efficiency (200VAC)(Typ) (*2)	%	87		
	Current (100/200VAC)(Typ) (*2)	A	7.2/3.7		
	Inrush Current (100/200VAC)(Typ) (*4)	A	20 / 40		
Leakage Current (*11)	mA	Less than 0.75 (0.2(Typ) at 100VAC / 0.44(Typ) at 230VAC)			
Output	Nominal Voltage	VDC	24	36	48
	Average Current	A	25	16.7	12.5
	Maximum Peak Current (100VAC/200VAC) (*1)	A	40.5/83	27/55.5	20/41.5
	Average Power	W	600	601.2	600
	Maximum Peak Power (100VAC) (*1)	W	972		
	Maximum Peak Power (200VAC) (*1)	W	1992	1998	1992
	Maximum Line Regulation (*6)	mV	96	144	192
	Maximum Load Regulation (*7)	mV	144	216	288
	Temperature Coefficient		Less than 0.02% / ° C		
	Maximum Ripple & Noise (0≤Ta≤70° C) (*5)	mVp-p	150	200	350
	Maximum Ripple & Noise (-10≤Ta<0° C) (*5)	mVp-p	200	250	400
	Hold-up Time (Typ) (*10)	ms	20ms		
	Voltage Adjustable Range	VDC	19.2 - 26.4	28.8 - 39.6	38.4 - 52.8
	Function	Over Current Protection (100VAC) (*8)	A	>41.3	>27.5
Over Current Protection (200VAC) (*8)		A	>84.6	>56.6	>42.3
Over Voltage Protection (*9)		VDC	27.6 - 32.4	41.4 - 48.6	55.2 - 64.8
Remote Sensing			-		
Remote ON/OFF Control			Possible		
Parallel Operation			Possible (2 units Max)		
Series Operation			Possible		
Monitoring Signal			PF(Open Collector Output)		
Line DIP			Designed to meet SEMI-F47 (200VAC Line only)		
Environment		Operating Temperature (*12)	°C	-10 - +70 (-10 - +50:100%,+70:50%)	
	Storage Temperature	°C	-30 - +85		
	Operating Humidity	%RH	10 - 90 (No dewdrop)		
	Storage Humidity	%RH	10 - 95 (No dewdrop)		
	Vibration		At no operating, 10 - 55Hz (Sweep for 1min) 19.6m/s ² Constant, X,Y,Z 1hour each		
	Shock (In package)		Less than 196.1m/s ²		
	Cooling		Forced Air By Blower Fan		
Isolation	Withstand Voltage		Input - FG : 2.5kVAC (20mA), Input - Output : 3kVAC (20mA) Output - FG: 500VAC (100mA), Output-CNT: 100VAC(100mA) for 1min		
	Isolation Resistance		More than 100MΩ Output - FG : 500VDC More than 10MΩ Output -CNT : 100VDC at 25° C and 70%RH		
Standards	Safety Standards (*13)		Approved by UL60950-1, CSA60950-1, EN60950-1, EN50178 Designed to meet DENAN		
	PFHC		Designed to meet IEC61000-3-2		
	EMI (*14)		Designed to meet EN55011/EN55022-B, FCC-B, VCCI-B		
	Immunity		Designed to meet IEC61000-4-2(Level 2,3), -3(Level 3), -4(Level 3), -5(Level 3,4), -6(Level 3), -8(Level 4), -11		
Mechanical	Weight (Typ)	g	1600		
	Size (W×H×D)	mm	100 x 82 x 165 (Refer to Outline Drawing)		

*Read instruction manual carefully, before using the power supply unit.

=NOTES=

(*1) Operating time at peak output is less than 5sec, duty is less than 35%. For details, refer to peak output condition.
When the peak output more than 5 sec is continued, the output is shut down, manual reset (CNT reset or Re power on).

(*2) At 100/200VAC, Ta=25°C and average output power.

(*3) For cases where conformance to various safety specs (UL, CSA, EN) are required, to be described as 100 - 240VAC(50/60Hz).

(*4) First inrush current. Not applicable for the inrush current to Noise Filter for less than 0.2ms.

(*5) Measure with JEITA RC-9131A probe, Bandwidth of scope :100MHz. At average output power.

(*6) 85 - 265VAC, constant load.

(*7) No load-Average load, constant input voltage.

(*8) OCP circuit will shut the output down, manual reset (CNT reset or Re power on).

(*9) OVP circuit will shut the output down, manual reset (CNT reset or Re power on).

(*10) At 100/200VAC, nominal output voltage and average output current.

(*11) Measured by the each measuring method of UL,CSA,EN and DENAN(at 60Hz), Ta=25°C.

(*12) Ratings - Derating at standard mounting. Refer to output derating curve.

- Load (%) is percent of average output power or average output current, whichever is greater.

(*13) As for DENAN, designed to meet at 100VAC.

(*14) At Ta=25°C and average output power.

Outline Drawing

SIGNAL CONNECTOR INFORMATION

CN1 PIN ASSIGN
S8B-PHDSS(JST)

- 1.COM
- 2.PC
- 3.NC
- 4.NC
- 5.CNT
- 6.TOG
- 7.PF
- 8.TOG

SIGNAL CONNECTOR USED

PART DESCRIPTION	PART NAME	MANUFACT
PIN HEADER	S8B-PHDSS	J.S.T.

MATCHING HOUSINGS, PINS & TOOL

PART DESCRIPTION	PART NAME	MANUFACT
SOCKET HOUSING	PHDR-08VS	J.S.T.
TERMINAL PINS	SPHD-002T-P0.5(AWG28 24) SPHD-001T-P0.5(AWG26 22)	J.S.T.
HAND CRIMPING TOOL	YRS-620(SPHD-002T-P0.5) YC-610R(SPHD-001T-P0.5)	J.S.T.

Output Derating

Ta (°C)	LOAD(%)	
	MOUNTING A	MOUNTING B
-10~+50	100	
70	50	

(*1) Load(%) is percent of average output power or average output current.
For example, load 100% refers to following condition when output is 24V model.
24[V], 12.5[A]

(*2) Peak output current does not need derating.

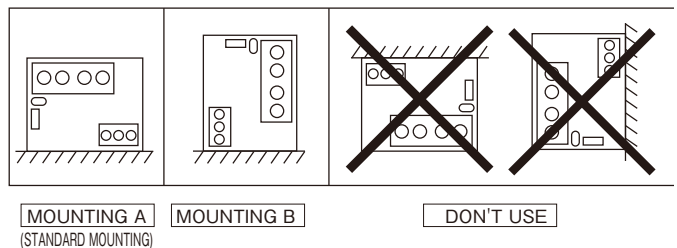
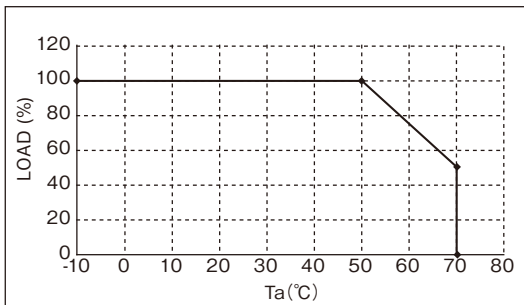

Peak Output Condition

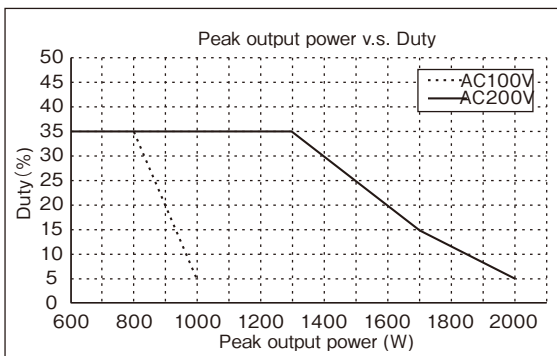

Duty = $\frac{\tau}{T} \times 100(\%)$ $\tau \leq 5(\text{sec})$

$$W_{avg} \geq W_m = \frac{W_p \times \tau}{T}$$

$$W_{avg} \geq W_m = \frac{(W_p - a) \times \tau + a}{T}$$

W_p : Peak output power (W)
 W_{avg} : Rated average output power(W)
 W_m : Average output power (W)
 τ : Pulse width of peak output power (sec)
 (Operating time at peak output)

T : Period (sec)
 Duty : The duty is pulse width peak output power of one period (%)

HWS300P-600P Series Instruction Manual

BEFORE USING THE POWER SUPPLY UNIT

Be sure to read this instruction manual thoroughly before using this product. Pay attention to all cautions and warnings before using this product. Incorrect usage could lead to an electrical shock, damage to the unit or a fire hazard.

⚠ DANGER

- Never use this product in locations where flammable gas or ignitable substances are present

⚠ WARNING

- Do not touch this product or its internal components while it is in operation, or shortly after shut down. There may be high voltage or high temperature present and you may receive an electric shock or burn.
- When the product is operating, keep your hands and face away from it; an accident may injure you.
- Do not make unauthorised changes to this product, otherwise you may receive an electric shock and void your warranty.
- Do not use this product in the event of the emission of smoke or abnormal smell and sound etc. It might lead to fire and/or electric shock. In such cases, please contact us. Do not attempt repair by yourself, as it is dangerous for the user.
- Do not operate these products in the presence of condensation. It might lead to fire and/or electric shock.
- Do not drop or insert anything into the product. It might lead to a failure, fire and/or electric shock. Do not use the product which dropped.

⚠ CAUTION

- This power supply is designed for use within an end product.
- Confirm connections to input/output terminals and signal terminals are correct as indicated in the instruction manual before switching on.

- Input voltage, Output current, Output power, ambient temperature and ambient humidity should be kept within specifications, otherwise the product will be damaged.
- Do not operate and store this product in an environment where condensation might occur. In such case, waterproof treatment is necessary.
- Do not use this product in environment with a strong electromagnetic field, corrosive gas or conductive substances.
- For applications which require very high reliability (Nuclear related equipment, traffic control equipment, etc.) it is necessary to provide a fail safe mechanism in the end equipment.
- The information in this document is subject to change without prior notice. Please refer to the latest version of the data sheet, etc., for the most up-to date specifications of the product.
- No part of this document may be copied or reproduced in any form without prior written consent of TDK-Lambda.
- Do not inject abnormal voltages into the output or signal of this product. The injection of reverse voltage or over voltage exceeding nominal output voltage into the output or signal terminals might cause damage to internal components.
- The output of this product is considered to be a hazardous energy level (The voltage is 2V or more and the power is 240VA or more). It must not be made accessible to users. Protection must be provided for Service Engineers against indirect contact with the output terminals and/or to prevent tools being dropped across them. While working on this product, the AC input power must be switched off and the input and output voltage should be zero.
- This product has a built-in fan for air-cooling. Do not block the air intake and exhaust as this might lead to fire.

CE MARKING

- CE Marking when applied to a product covered by this handbook indicates compliance with the low voltage directive (2006/95/EC) in that it complies with EN60950-1.

1. Terminal Explanation

Please pay extra attention to the wiring. Incorrect connection will damage the power supply.

1 Front Panel Explanation

HWS300P

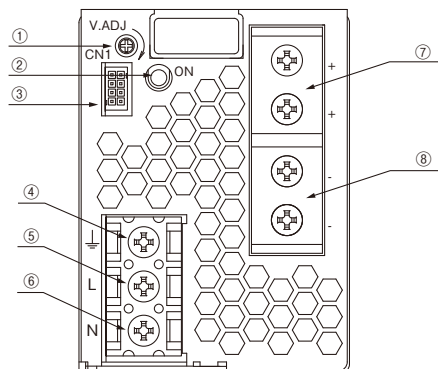

- ① V.ADJ : Output voltage adjustment trimmer.
(The output voltage rises when a trimmer is turned clockwise.)
- ② ON : Output (Power On) indication LED.
(The indicator turns on when the power supply output is in normal operating condition.)
- ③ CN1 : ON/OFF control signal, Current balance signal (only as for HWS600P), Power fail signal. (Refer to 2-2.)

HWS600P

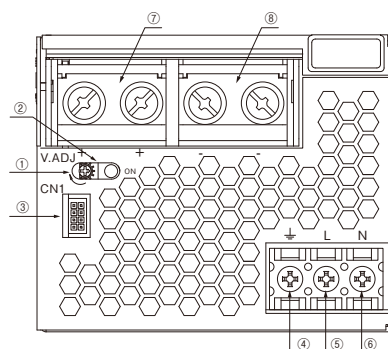

- ④ \perp : Protective Earth terminal (Frame ground), M4 screw.
- ⑤ AC input terminal L : Live Line (Fuse in line), M4 screw.
- ⑥ AC input terminal N : Neutral line, M4 screw.
- ⑦ + : + Output terminal (HWS300P: M4 screw x 2 / HWS600P: M5 screw x 2)
- ⑧ - : - Output terminal (HWS300P: M4 screw x 2 / HWS600P: M5 screw x 2)

2 CN1 Connector pin Configuration and Function

	Pin No..	Configuration	Function
	1	COM	GND for PC signals (Only as for HWS600P. HWS300P is NC.)
	2	PC	Current balance terminal. (For output current balancing in parallel operation. Only as for HWS600P. HWS300P is NC.)
	3	NC	No connect
	4	NC	No connect
	5	CNT	Remote ON/OFF control terminal.(Power supply ON/OFF control with an external signal.)
	6	TOG	GND for CNT and PF signals. (Same as Pin No.8)
	7	PF	Power fail signal (PF signal) output terminal. (Uses the open collector method. As the output voltage drops, or FAN stops, "Power Fail" terminal will output "High" .)
	8	TOG	GND for CNT and PF signals. (Same as Pin No.6)

CN1 Connector & Housing & Terminal Pin

PART DESCRIPTION	PART NAME	MANUFACT
PIN HEADER	S8B-PHDSS	J.S.T.
SOCKET HOUSING	PHDR-08VS	J.S.T.
TERMINAL PINS	SPHD-002T-P0.5(AWG28 - 24)	J.S.T.
	SPHD-001T-P0.5(AWG26 - 22)	J.S.T.
HAND CRIMPING TOOL	YRS-620(SPHD-002T-P0.5)	J.S.T.
	YC-610R(SPHD-001T-P0.5)	J.S.T.

3. Terminal Connection Method

Please pay extra attention to the wiring. Incorrect connection will damage the power supply.

- When connecting input and output wiring, and CN1, input AC-Line should be off.
- Input wiring and output wiring shall be separated to improve noise sensibility.
- The protective earth (PE) must be connected to the terminal or chassis.
- Remote ON/OFF control lines shall be twisted or used shielded wires. Separate from load line.
- Output current of each terminal screw shall be less than 40A for HWS300P. And shall be less than 60A for HWS600P.

• ON/OFF control required

"TOG" terminal is ground for "CNT" terminal.

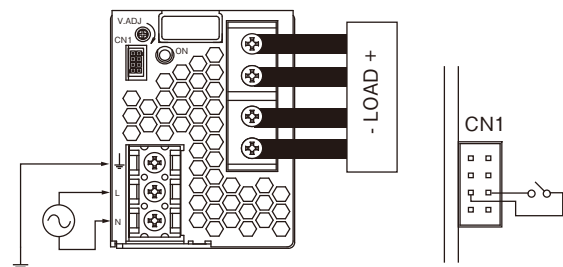

HWS300P Panel Side (Common HWS600P)

• Basic connection

Connect "CNT" terminal to "TOG" terminal with the attached connector.

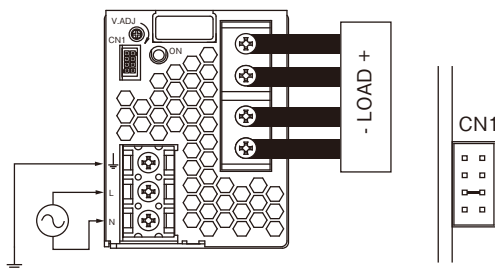

• PF signal output required

Open collector method shown below shall be used. "TOG" terminal is ground for "PF" terminal.

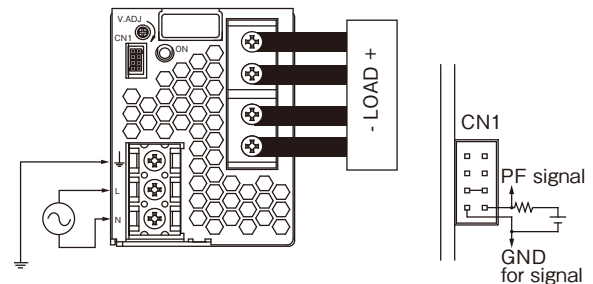

4. Functions and Precautions

1 Input Voltage Range

Input voltage range is single phase 85 - 265VAC (47 - 63Hz) or 120 - 330VDC. Input voltage, which is out of specification, may cause unit damage. Rated input voltage for safety standard application is 100 - 240VAC(50/60Hz).

2 Output Voltage Range

Output voltage is set to the rated voltage value at shipment. V.ADJ trimmer on the front panel side is used to adjust the output voltage within the range specified.

Output voltage range is within -20% - $+10\%$ of rated output voltage.

To turn the trimmer clockwise, the output voltage will be increased. Take note when the output voltage is increased excessively, over voltage protection (OVP) function may trigger and output voltage will be shut down.

When output voltage increased, average output power and peak output power have to use less than specification.

3 Over Voltage Protection (OVP)

The OVP function (Inverter shutdown method, manual reset type) is provided. OVP function operates within 115-135% of the rated output voltage value, and the output will be shut down when OVP function trigger. To reset OVP, remove the input of power supply for a few minutes, and then re-input. Or, use CNT reset (remote ON/OFF : OFF to ON). OVP value is fixed and not to be adjusted externally.

Never apply more than rated output voltage to output terminal, which may lead damage to power supply. In the case of inductive load, use decoupling diode at output line.

4 Delay Shut Down

This product have a delay shut down function provided to protect power supply and equipment at the time of the consecutive peak current. When the product operate peak current for more than 5 seconds, delay shut down function operates and the output will be shut down.

To reset delay shut down, remove the input of power supply for a few minutes, and then re-input. Or, use CNT reset (remote ON/OFF : OFF to ON).

Delay Shut Down Time value is fixed and not to be adjusted externally.

Use it about the peak electricity in specifications range. The details see at "4-14. Output Peak Power" .

5 Over Current Protection (OCP)

The OCP function (manual reset type) is provided. Output will be shut down in condition over current or output short-circuit.

To reset OCP, remove the input of power supply for a few minutes, and then re-input. Or, use CNT reset (remote ON/OFF : OFF to ON).

Also avoid over current condition or output short-circuit.

Otherwise the product will be damage.

OCP value is fixed and not to be adjusted externally.

6 Over Temperature Protection (OTP)

The OTP function (manual reset type) is provided. When ambient or internal temperature rises abnormally, OTP function operates and output will be shut down. After shut down, remove the input and cool it down to reset OTP. Then re-input.

Or, use CNT reset (remote ON/OFF : OFF to ON).

7 Low Output Detection Circuit (PF)

Low output voltage detection circuit is provided. Power Fail (PF) signal will turn "High" level to indicate the abnormal status when the output voltage becomes within 65 ~ 80% of rated value caused by either the drop or brownout of the input voltage or OCP, OVP, Delay Shut Down and OTP etc function operation. When the built-in FAN motor of this power supply unit stops, PF signal will turn to "H" . The PF signal is isolated from input and output by a photo-coupler. It uses the open collector method shown in below.

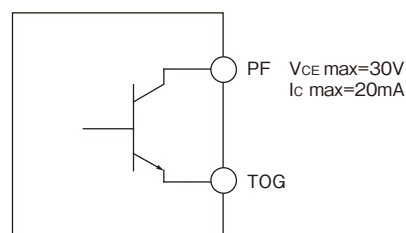

8 Remote ON/OFF Control

Remote ON/OFF control is provided.

Using this function, output on/off is allowed to control without input voltage on/off. The output is turned to ON when TOG and CNT terminals are shorted, and the output is turned to OFF when these terminals are opened. When the function is not used, connect TOG and CNT terminals. The standards for this function are as follows. "TOG" terminal is return for "CNT" terminal.

- (1) TTL compatible. The maximum input voltage to CNT terminal is 12V, and the maximum allowable reverse voltage is $-1.0V$. The sink current for CNT terminal is 3.5mA.
- (2) A switch and relay or a transistor can be used as ON/OFF switch.
- (3) Remote ON/OFF control circuit is isolated from the input and output by a photo-coupler and can be controlled regardless of the output potential (+ or -). Connect TOG terminal to ground of control signal.

The mode of control

CNT Level for TOG Terminal	Output	Built-in Fan
Short or L (0V - 0.8V)	ON	Rotate
Open or H (2.4V - 12V)	OFF	Stop

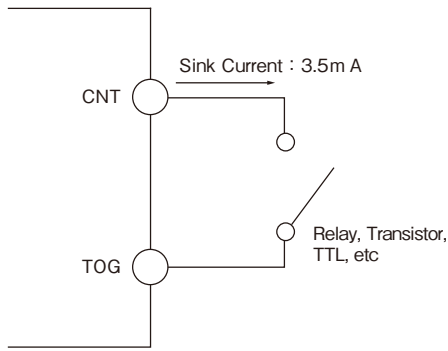

9 Output Ripple & Noise

The standard specification for maximum ripple value is measured specified measurement circuit (JEITA-RC9131A). When load lines are longer, ripple becomes larger. In this case, electrolytic capacitor, film capacitor, etc. might be necessary to use across the load terminal. The output ripple cannot be measure accurately if the probe ground lead of oscilloscope is too long.

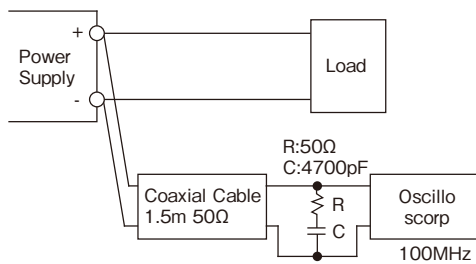

10 Series Operation

For series operation, both method (A) and (B) are possible. There might be a step in the output rise waveform during series operation.

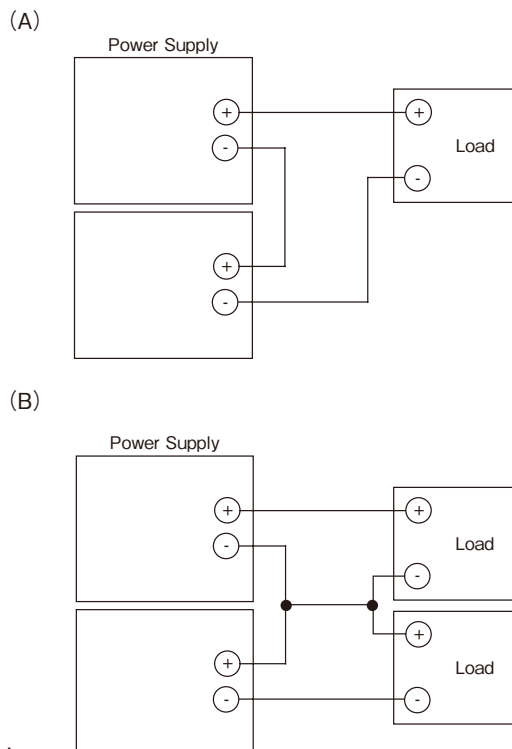

11 Parallel Operation

Both operations mode (A) and (B) are possible.

(A) To Increase the Output Current(only as for HWS600P) Current balancing function is provided. Connecting PC to PC terminal and COM to COM terminal, the current balancing function activates and output current of each power supply is equivalently supplied to load. Wires to PC terminals, COM terminals shall be as short as possible and same length and twisted. Parallel operation is possible up to 2 units.

- 1) Adjust the output voltage of each power supply to be same value within 100mV.
- 2) Use same length and type of wires for all load lines.
- 3) Use the power supply within the rated output current for all paralleled models.

(B) To Use as a Backup Power Supply

- 1) Adjust the output voltage of each power supply to be same value.
- 2) Set power supply output voltage higher by the forward voltage drop of diode.
- 3) Use within the specifications for output voltage and output power.

Method (A) To Increase the Output Current (only as for HWS600P)

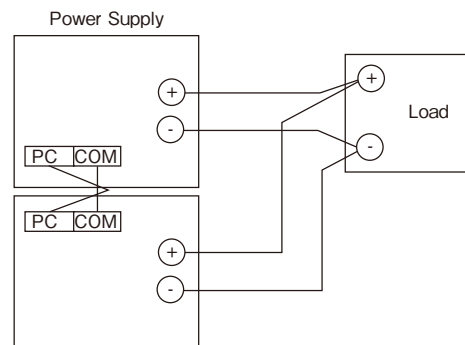

Method (B) To Use as a Backup Power Supply

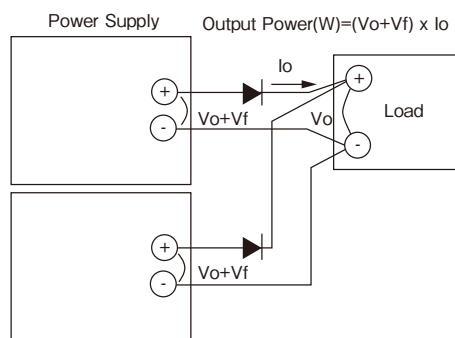

12 Isolation Test

Isolation resistance between output and \perp (chassis) shall be more than 100M Ω at 500VDC and between output and CNT·PF shall be more than 10M Ω at 100VDC. For safety operation, voltage setting of DC isolation tester must be done before the test. Ensure that it is fully discharged after the test.

Output - FG (chassis) : 500VDC 100M Ω or more

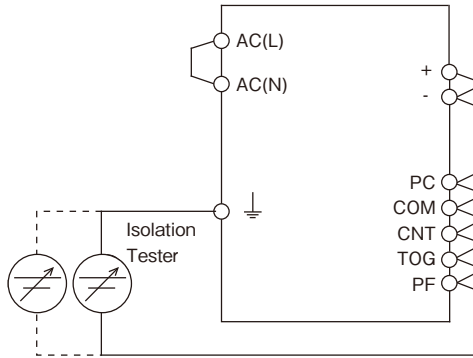

Output - CNT · PF : 100VDC 10M Ω or more

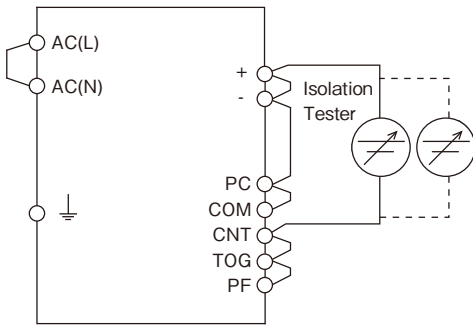

Note 1. "PC" and "COM" are NC in HWS300P.

13 Withstand Voltage

This series is designed to withstand 3.0kVAC between input and output, 2.5kVAC between input and \perp (chassis), 500VAC between output and \perp (chassis), and 100VAC between output and CNT·PF terminal each for 1 minute. When testing withstand voltage, set current limit of withstand voltage test equipment at 20mA.

(Output- (chassis) and Output-CNT·PF: 100mA).

The applied voltage must be gradually increased from zero to testing value and then gradually decreased for shut down. When timer is used, the power supply may be damaged by high impulse voltage at timer switch on and off. Connect input and output as follows.

In the test by state of output open, there is a thing that output voltage is generated momentarily.

Input - Output (dotted line) : 3.0kVAC 1min. (20mA)
 Input - \perp (chassis) (solid line) : 2.5kVAC 1min. (20mA)

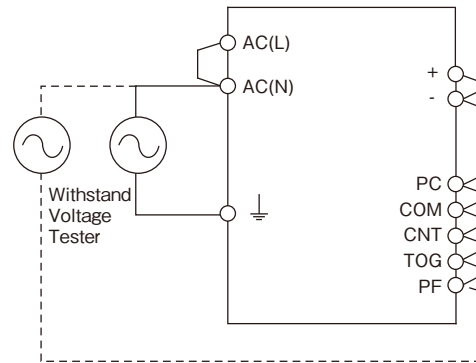

Output - \perp (chassis) : 500VAC 1min. (100mA)

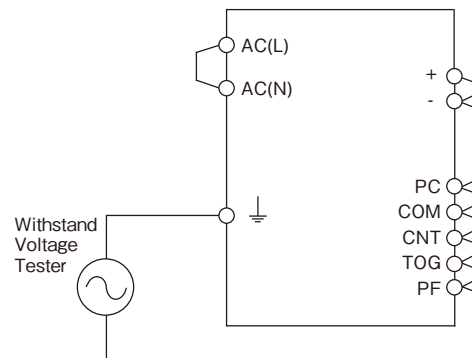

Output - CNT · PF : 100VAC 1min. (100mA)

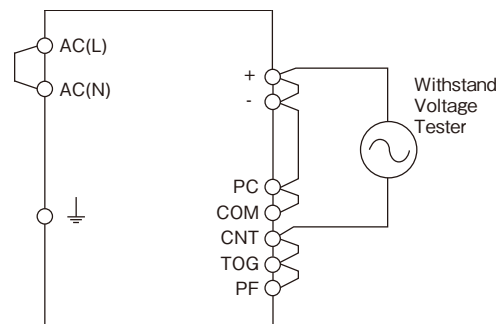

Note 1 "PC" and "COM" are NC in HWS300P.

Note 2 This product have monolithic ceramic capacitor in secondary circuit to frame ground.

Some of the withstand voltage tester may generate high voltage at the matching with monolithic ceramic capacitor and may cause the unit damage. So, please check the waveform of test voltage.

14 Output Peak power

This product must be use to satisfy (a) and (b). Allowable peak output operating time is less than 5sec. When the product operate peak power for more than 5 sec, the delay shut down function operates and the output will shut down.

Peak output power and average output power use less than specification.

Peak output power is limited depending on Duty. The details see at (b).

The product might be damage to use beyond the limits of (a) and (b).

When using pulse load, a noise may be heard from power supply unit. Please evaluate and check before using.

(a) Expression of relations

A formula about Duty

$$\text{Duty} = \frac{\tau}{T} \times 100 (\%)$$

A formula about average output power

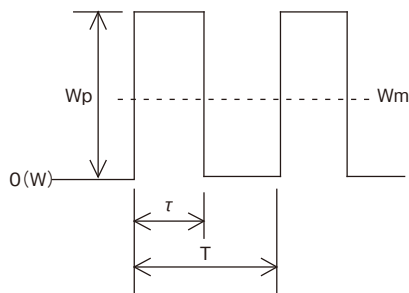

$$W_{\text{av}} \leq W_m = \frac{W_p \times \tau}{T}$$

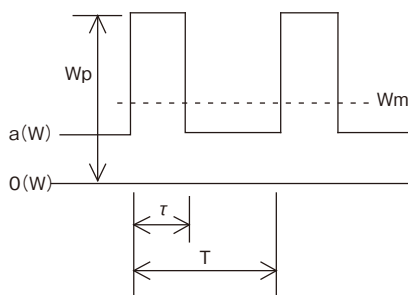

$$W_{\text{av}} \leq W_m = \frac{(W_p - a) \times \tau}{T} + a$$

- Wp : Peak output power (W)
- Wav : Rated average output power(W)
(Average output power of Specification)
- Wm : Average output power (W)
- τ : Pulse width of peak output power (sec)
(Operating time at peak output)
- T : Period (sec)

(b) Peak output power VS Peak Duty

HWS300P

Vin:100VAC(dotted line)/Vin:200VAC(solid line)

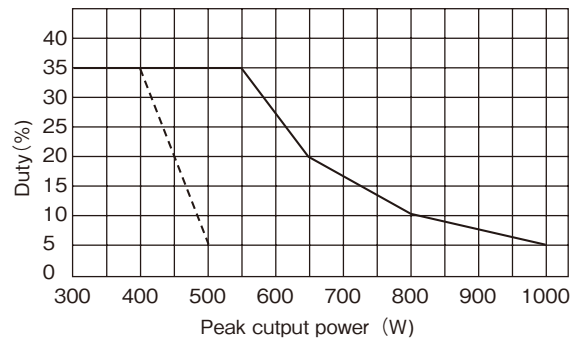

HWS600P

Vin:100VAC(dotted line)/Vin:200VAC(solid line)

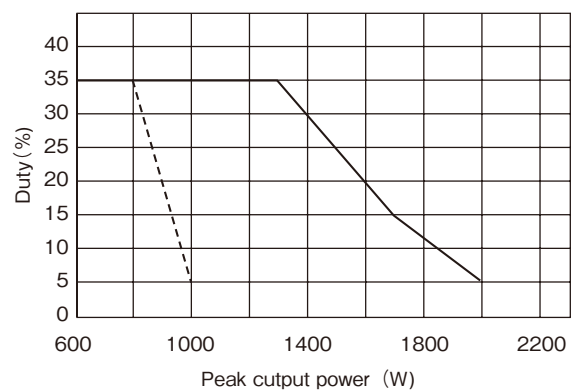

5. Mounting Directions

1 Output Derating according to the Mounting Directions.

Recommended standard mounting method is (A). Method (B) is also possible.

Refer to the derating below.

HWS300P

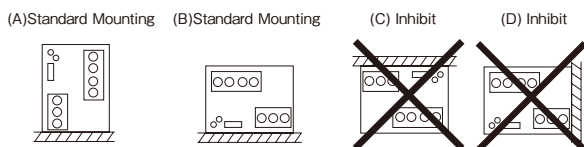

HWS600P

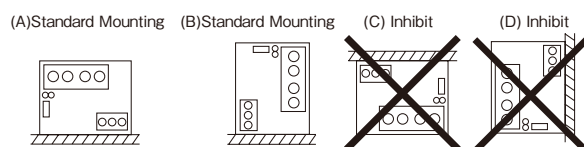

2 Output Derating

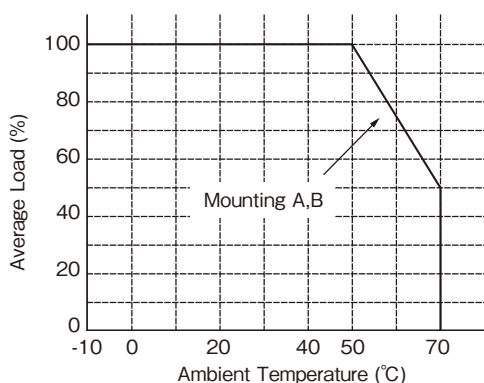

Ta(°C)	Average Load (%)	
	Mounting(A)	Mounting(B)
-10 ~ +50	100	
+70	50	

Note 1, Peak power does not have the derating.

3 Mounting Method

- Forced air-cooling type power supply.
This power supply has ventilating holes on the front and back side panels. Keep these two areas freely as much as possible.
- The maximum allowable penetration is 6mm.
Incomplete thread of mounting screw should not be penetrated.
- Recommended torque for mounting screw : M4 screw : 1.27 N · m (13.0kgf · cm)

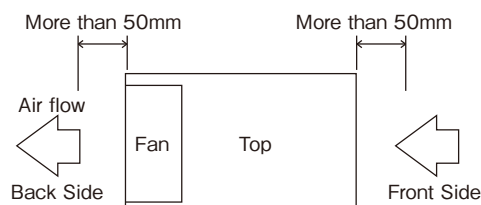

6. Wiring Method

- The output load line and input line shall be separated to improve noise sensitivity.
- Use all lines as thick and short as possible to make lower impedance.
- Attaching a capacitor to the load terminals can eliminate noise.
- For safety and EMI considerations, connect terminal to the mounting set ground terminal.
- Recommended torque for the terminal ;
HWS600P Output terminal (M5 screw)
: 2.50 N · m (25.5kgf · cm)
HWS300P Input, Output terminal & HWS600P Input terminal (M4 screw)
: 1.27 N · m (13.0kgf · cm)

[The PHD connector manufacture method]

This product is using SPHD-001T-P0.5 or SPHD-002T-P0.5 connector made from JAPAN SOLDERLESS TERMINAL MFG CO LTD.

Regarding to manufacture of a connector, it becomes the regulation as following.

a). Applicable Wire and Crimping tool

Wire size to use for SPHD-001T-P0.5 is AWG#26 ~ AWG#22 and insulation outer diameter is $\phi 1.0 \sim \phi 1.5$ mm.
Wire size to use for SPHD-002T-P0.5 is AWG#28 ~ AWG#24 and insulation outer diameter is $\phi 0.9 \sim \phi 1.5$ mm.
Crimping tool is as blow.

Crimping tool	Crimping applicator	Dies
AP-K2 or AP-KS	MKS-LS-10 or MKS-L-10	SPHD-001-05/SPHD-002-05

b). Crimping Operation

The reference value of wire strip is 2.3mm. As wire strip length differs depending on type of wire and crimping method, decide the best wire strip length considering processing condition. When wire is stripped, do not damage or cut off wire conductors.

Table of crimp height
SPHD-001T-P0.5

Wire Size	Insulation O.D (mm)	Crimp height (mm)	
		Conductor part	Conductor part
AWG#26	1.3	0.60 ~ 0.70	1.7
AWG#24	1.5	0.65 ~ 0.75	1.8
AWG#22	1.4	0.70 ~ 0.80	1.8

SPHD-002T-P0.5

Wire Size	Insulation O.D (mm)	Crimp height (mm)	
		Conductor part	Conductor part
AWG#28	1.2	0.55 ~ 0.60	1.6
AWG#26	1.3	0.60 ~ 0.65	1.7
AWG#24	1.5	0.62 ~ 0.67	1.8

- Note 1. Crimp height at wire barrel should be set to pre-determined dimensions.
- Note 2. Adjust crimp height at wire insulation barrel to the extent that wire insulation is slightly pressed, and set it so that crimping is not excessivary.
- Note 3. Crimping condition at wire insulation barrel is as below Fig.1.
- Note 4. For AWG#28,#26,#24, use UL1007 type. For AWG#22, use UL1061 type.



Good

Fig.1

Table of tensile strength at crimped part.
SPHD-001T-P0.5

Wire size	Requirement N min.	Actual value N
AWG#26	20	39.2 ~ 45.1
AWG#24	30	68.6 ~ 74.5
AWG#22	40	92.1 ~ 96.0

SPHD-002T-P0.5

Wire size	Requirement N min.	Actual value N
AWG#28	15	27.0 ~ 34.3
AWG#26	20	44.1 ~ 48.0
AWG#24	30	66.6 ~ 71.5

Fig.2: Examples of defective crimping

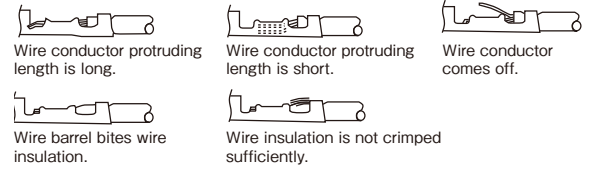

c). Inserting contact into housing

- (1) Do not apply any pulling force to crimped part, and insert contact parallel to housing.
- (2) Insert contact into housing without stopping to innermost.
- (3) Check secure locking per each insertion by pulling wire softly in order to check that contact does not come off housing. Besides, check whether there is the backlash in the direction of insertion axis.

Defect example of slating insertion

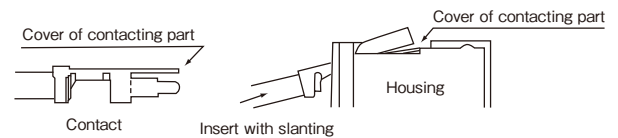

d). Mating and Unmating Connector

- (1) Inserting connector
Hold receptacle housing securely and insert into header straight against to header post until click sounds.
- (2) Unmating connector
Hold all wires securely and fix receptacle housing by fingers so as to pry, and then, withdraw it on the mating axis.

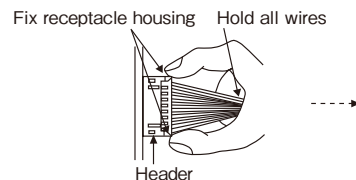

e). Routing of Wire

Routing wire so as not to apply external force to connector except force to such an extent that wire slightly buckles, considering an enough length to route and fixing of wire.

7. External Fuse Rating

Refer to the following fuse rating when selecting the external fuses that are to be used on input line. Surge current flows when line turns on. Use slow-blow or time-lag type fuse, not fast-blow fuse. Fuse rating is specified by in-rush current value at line turn-on. Do not select the

fuse according to input current (RMS.) values under the actual load condition.

HWS300P : 12A
HWS600P : 20A

8. Fan life expectancy

The Fan-life has limitation. Therefore, periodic maintenance by exchanging the life-expired fan is required for the power supply. The following figure shows the life of fan. The built-in FAN motor replacement is charged. Please contact to our sales office for FAN replacement.

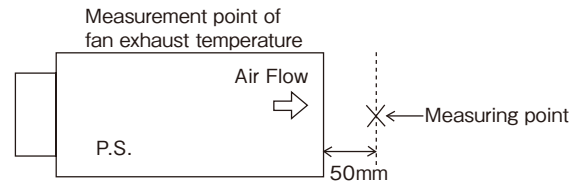
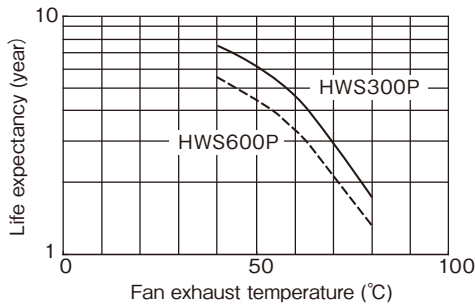

The difference between the intake temperature and the exhaust temperature of the Power supply at average load.

HWS300P : 4°C

HWS600P : 8°C

9. Before concluding that the unit is at fault...

Before concluding that the unit is at fault, make the following checks.

- (1) Check if the rated input voltage is connected.
- (2) Check if the wiring of input and output is correct.
- (3) Check if the I/O terminal connection is properly tighten by regulated torque.
- (4) Check if the wire thickness is enough.
- (5) Check if the output voltage control (V.adj) is properly adjusted. OVP might be triggered and output is shut down.
- (6) If use function of the Remote ON/OFF control, check if the Remote ON/OFF control connector is not opened. If in open condition, power supply will not output.
- (7) Check if the built-in FAN is not stopped. Is FAN stopped by something irregulars or etc?
If FAN stops, the PF signal turn "High" level and OTP might be activated.
- (8) Power supply has ventilating holes on the front and back panels. Check if there is any irregulars or dust, etc.
- (9) Is the chassis of power supply hot abnormally? The output is shut down by OTP operation.
Please re-input after the unit to cool down sufficiently.
- (10) Check if the output current and output wattage does not over specification.
- (11) Audible noise may be heard when input voltage waveform is not sinusoidal.
- (12) Audible noise may be heard during dynamic load operation.

10. Range of free warranty

This product is warranted for a period of 5 years from the date of shipment. As for the breakdown under a normal use during free warrantee term, repair is at free of charge. However, the built-in FAN motor replacement is charged.

Please contact to our sales office for FAN replacement. Please see "8. fan life expectancy" for the exchange time of fan.

Conditions of usage at the free of charge warrantee are as follows.

- (1) Average operating temperature (ambient temperature of the power supply unit) is under 40°C
- (2) Average load factor is 80% or less.
- (3) Mounting method : Standard mounting.

However, the maximum rating is within the output derating.

Following cases are not covered by warranty.

- (1) Improper usage like dropping products, applying shock and defects from operation exceeding specification of the units.
- (2) Defects resulting from natural disaster (fire, flood).
- (3) Unauthorized modifications or repair by the buyers defects not cause by TDK-Lambda.

TDK-Lambda

Catalog Usage Precautions

Please observe the following points when using this catalog for power supplies and related products of TDK-Lambda Corporation (hereafter referred to simply as "our products"). Be sure to carefully read all precautions stated below before beginning to use our products.

1. The contents of this catalog are subject to change without notice, for example related to product improvements and other instances. Always check the latest information before deciding on a product.
2. Our products are designed and manufactured under the assumption that they will be used as integrated power supplies for normal industrial applications. They are not designed and manufactured for use in high-safety applications (applications requiring very high reliability and safety levels, where a reliability or safety problem could directly involve the risk of serious injury or death). If the customer decides to use our products in a high-safety application, appropriate fail-safe design features must be provided (such as incorporating protective circuitry and/or protective equipment in the system, or incorporating redundancy in the system so that a single failure cannot lead to instability). TDK-Lambda Corporation does not assume liability for any claims or damages either by the customer or third parties arising from the use of our products for high-safety applications.
3. When designing equipment in which our products are to be used, as well as peripheral circuitry for such equipment, always observe the "Product Usage Precautions" noted in this catalog and/or the product documentation and ensure that maximum ratings, power supply voltage range, operation temperature range and other specifications are not exceeded. TDK-Lambda Corporation does not assume liability for any claims or damages arising from the use of our products in a way that exceeds specifications, or from a type of usage indicated as unsuitable for the respective product in this catalog.
4. The operation outline and usage descriptions given in this catalog are examples. Before actual use of a product, all external factors must be examined carefully in order to ensure appropriate circuit and implementation design. TDK-Lambda Corporation does not assume liability for any claims or damages arising from indirect problems such as EMI or mechanical effects from our products.
5. The technical information included in this catalog is intended only for the purpose of illustrating representative operation or application of our products. It does not imply any guarantee or granting of license for intellectual property rights or other rights held either by TDK-Lambda Corporation or third parties. TDK-Lambda Corporation does not assume liability for any problems with third parties related to intellectual property rights arising from the use of our products.
6. Products listed in this catalog may require export permission or authorization in compliance with the Foreign Exchange and Foreign Trade Act.
7. The contents of this catalog may not be reproduced or copied without permission by TDK-Lambda Corporation.
8. For any inquiries regarding this catalog, please contact the Sales Department of TDK-Lambda Corporation.



TDK-Lambda Corporation

NIHONBASHI OFFICE

6F Nittetsu Bldg.1-13-1 Nihonbashi, Chuo-ku, Tokyo 103-0027 Japan

Tel: +81-3-5201-7140 Fax: +81-3-5201-7139

<http://www.tdk-lambda.com/>

Change of Content Specifications or designs in this catalog are subject to change due to improvements without prior notice.

Trademarks Company names, product names, service marks and/or logos used, quoted and/or referenced in this catalog are trademarks or registered trademarks of TDK Corporation or TDK-Lambda Corporation or any of its affiliates in Japan and other countries. Not all trademarks or registered trademarks stated herein are followed by (R) or (TM).

TDK logo TDK logo is a trademark or registered trademark of TDK Corporation.