

NOTE:

1. MATERIAL:
HOUSING: PA46 GLASS FILLED, UL94V-0, COLOR: NATURAL
TERMINAL: COPPER ALLOY
2. PLATING: 1) 0.10 μm MIN. GOLD PLATING OVER NICKEL PLATING OVERALL
2) 1-3 μm TIN-BISMUTH OVER NICKEL PLATING OVERALL
3. PRODUCT SPECIFICATION: PS-78119-001
4. PRODUCT ARE PACKED IN TAPE & REEL.

REVISED	IEC NO: J2012-1253	QUALITY SYMBOLS ▽=0 ◻=0	GENERAL TOLERANCES (UNLESS SPECIFIED)		DIMENSION STYLE MM ONLY		SCALE NTS	DESIGN UNITS METRIC	THIRD ANGLE PROJECTION		
	DRW:KMIYAHARA 2012/03/23		4 PLACES	mm	INCH	DRAWN BY YLOIAO	DATE 2006/04/11	TITLE 0.50MM PITCH, FPC CONN. NON-ZIF, SMT			
	CH'KD:KATAHASHI 2012/03/26		3 PLACES	± ---	± ---	CHECKED BY BOKOK	DATE 2006/04/18				
	APPR:KIMORI KAWA 2012/03/30		2 PLACES	± 0.15	± ---	APPROVED BY PTLIM	DATE 2006/04/18	MOLEX INCORPORATED		DOCUMENT NO. SD-78119-001	
REV	1 PLACE	± ---	± ---	MATERIAL NO. SEE TABLE		SHEET NO. 1 OF 7					
DRAFT WHERE APPLICABLE MUST REMAIN WITHIN DIMENSIONS			ANGULAR ± 3 °		THIS DRAWING CONTAINS INFORMATION THAT IS PROPRIETARY TO MOLEX INCORPORATED AND SHOULD NOT BE USED WITHOUT WRITTEN PERMISSION						

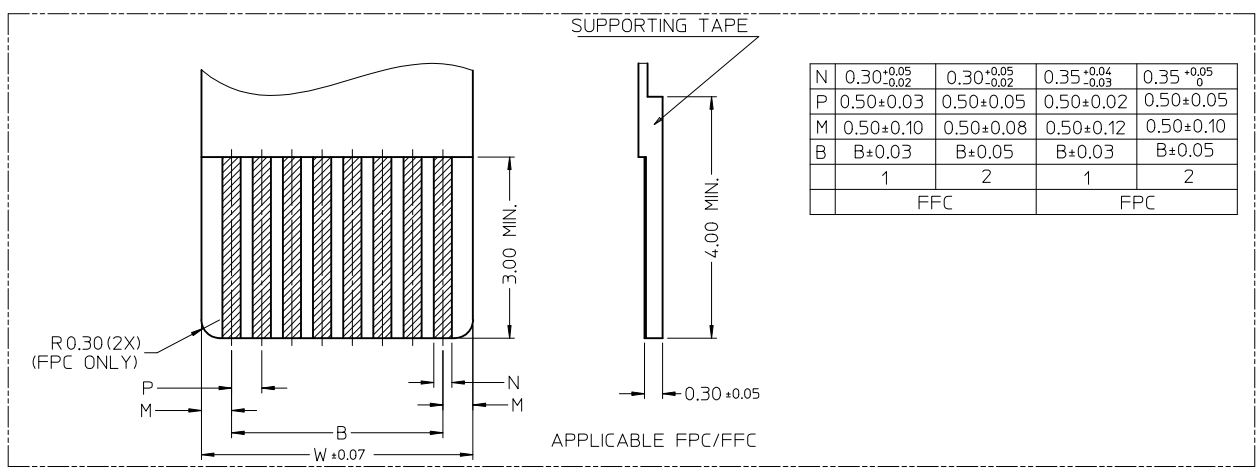
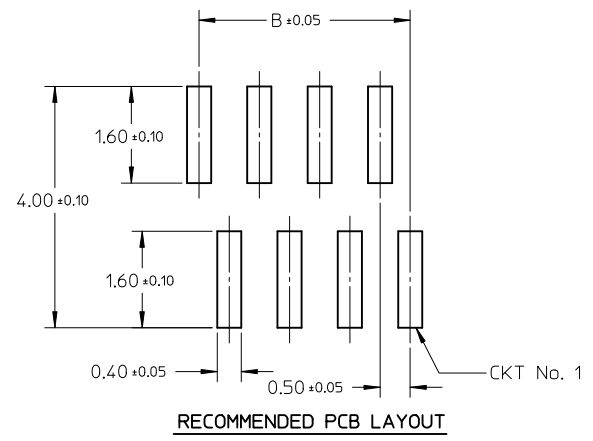

REVISED EC NO: J2012-1253 DRWN: KMIYAHARA 2012/03/23 CHYKD: KTAHASHI 2012/03/26 APPR: KMORIKAWA 2012/03/30	QUALITY SYMBOLS	GENERAL TOLERANCES (UNLESS SPECIFIED)		DIMENSION STYLE	SCALE	DESIGN UNITS	THIRD ANGLE PROJECTION	
	▽=0 ◻=0	mm	INCH	MM ONLY	N/T	METRIC		
		4 PLACES ± ---	± ---	DRAWN BY	DATE	TITLE		
		3 PLACES ± ---	± ---	YLO1A0	2006/04/11	0.50MM PITCH, FPC CONN. NON-ZIF, SMT		
	2 PLACES ± 0.15	± ---	CHECKED BY	DATE	MOLEX INCORPORATED			
	1 PLACE ± ---	± ---	BOKOK	2006/04/18	DOCUMENT NO.			
	ANGULAR ± 3 °		APPROVED BY	DATE	SHEET NO.			
			PTLIM	2006/04/18	SD-78119-001			
			MATERIAL NO.		2 OF 7			
			SEE TABLE		THIS DRAWING CONTAINS INFORMATION THAT IS PROPRIETARY TO MOLEX INCORPORATED AND SHOULD NOT BE USED WITHOUT WRITTEN PERMISSION			

GOLD PLATING TERMINAL ASSEMBLY PART NUMBERS

ASSY P/N W/O PACKAGING	CKT	DIM A	DIM B	DIM C	DIM D	PLATING TYPE
78119-0108	10	7.10	4.50	6.40	5.60	1
78119-0118	11	7.60	5.00	6.90	6.10	
78119-0128	12	8.10	5.50	7.40	6.60	
78119-0138	13	8.60	6.00	7.90	7.10	
78119-0148	14	9.10	6.50	8.40	7.60	
78119-0158	15	9.60	7.00	8.90	8.10	
78119-0168	16	10.10	7.50	9.40	8.60	
78119-0178	17	10.60	8.00	9.90	9.10	
78119-0188	18	11.10	8.50	10.40	9.60	
78119-0198	19	11.60	9.00	10.90	10.10	
78119-0208	20	12.10	9.50	11.40	10.60	
78119-0218	21	12.60	10.00	11.90	11.10	
78119-0228	22	13.10	10.50	12.40	11.60	
78119-0238	23	13.60	11.00	12.90	12.10	
78119-0248	24	14.10	11.50	13.40	12.60	
78119-0258	25	14.60	12.00	13.90	13.10	
78119-0268	26	15.10	12.50	14.40	13.60	
78119-0278	27	15.60	13.00	14.90	14.10	
78119-0288	28	16.10	13.50	15.40	14.60	
78119-0298	29	16.60	14.00	15.90	15.10	
78119-0308	30	17.10	14.50	16.40	15.60	

ASSY P/N W/O PACKAGING	CKT	DIM A	DIM B	DIM C	DIM D	PLATING TYPE
78119-0318	31	17.60	15.00	16.90	16.10	1
78119-0328	32	18.10	15.50	17.40	16.60	
78119-0338	33	18.60	16.00	17.90	17.10	
78119-0348	34	19.10	16.50	18.40	17.60	
78119-0358	35	19.60	17.00	18.90	18.10	
78119-0368	36	20.10	17.50	19.40	18.60	
78119-0378	37	20.60	18.00	19.90	19.10	
78119-0388	38	21.10	18.50	20.40	19.60	
78119-0398	39	21.60	19.00	20.90	20.10	
78119-0408	40	22.10	19.50	21.40	20.60	

REVISED EEC NO: J2012-1253 DRW: KMIYAHARA 2012/03/23 CHK: KDKTAKAHASHI 2012/03/26 APPR: KMORIKAWA 2012/03/30	QUALITY SYMBOLS	GENERAL TOLERANCES (UNLESS SPECIFIED)	DIMENSION STYLE	SCALE	DESIGN UNITS	THIRD ANGLE PROJECTION
	=0 =0	mm INCH 4 PLACES ± --- ± --- 3 PLACES ± --- ± --- 2 PLACES ± 0.15 ± --- 1 PLACE ± --- ± --- ANGULAR ± 3 °	MM ONLY	NTS	METRIC	
		DRAFT WHERE APPLICABLE MUST REMAIN WITHIN DIMENSIONS	DRAWN BY: YLQIAO DATE: 2006/04/11 CHECKED BY: BOKOK DATE: 2006/04/18 APPROVED BY: PTLIM DATE: 2006/04/18	TITLE	0.50MM PITCH, FPC CONN. NON-ZIF, SMT	
	A3		SEE TABLE	MATERIAL NO.	DOCUMENT NO.	SHEET NO.

THIS DRAWING CONTAINS INFORMATION THAT IS PROPRIETARY TO MOLEX INCORPORATED AND SHOULD NOT BE USED WITHOUT WRITTEN PERMISSION

TIN-BISMUTH PLATING TERMINAL ASSEMBLY PART NUMBERS

ASSY P/N W/O PACKAGING	CKT	DIM A	DIM B	DIM C	DIM D	PLATING TYPE
78119-0109	10	7.10	4.50	6.40	5.60	2
78119-0119	11	7.60	5.00	6.90	6.10	
78119-0129	12	8.10	5.50	7.40	6.60	
78119-0139	13	8.60	6.00	7.90	7.10	
78119-0149	14	9.10	6.50	8.40	7.60	
78119-0159	15	9.60	7.00	8.90	8.10	
78119-0169	16	10.10	7.50	9.40	8.60	
78119-0179	17	10.60	8.00	9.90	9.10	
78119-0189	18	11.10	8.50	10.40	9.60	
78119-0199	19	11.60	9.00	10.90	10.10	
78119-0209	20	12.10	9.50	11.40	10.60	
78119-0219	21	12.60	10.00	11.90	11.10	
78119-0229	22	13.10	10.50	12.40	11.60	
78119-0239	23	13.60	11.00	12.90	12.10	
78119-0249	24	14.10	11.50	13.40	12.60	
78119-0259	25	14.60	12.00	13.90	13.10	
78119-0269	26	15.10	12.50	14.40	13.60	
78119-0279	27	15.60	13.00	14.90	14.10	
78119-0289	28	16.10	13.50	15.40	14.60	
78119-0299	29	16.60	14.00	15.90	15.10	
78119-0309	30	17.10	14.50	16.40	15.60	

ASSY P/N W/O PACKAGING	CKT	DIM A	DIM B	DIM C	DIM D	PLATING TYPE
78119-0319	31	17.60	15.00	16.90	16.10	2
78119-0329	32	18.10	15.50	17.40	16.60	
78119-0339	33	18.60	16.00	17.90	17.10	
78119-0349	34	19.10	16.50	18.40	17.60	
78119-0359	35	19.60	17.00	18.90	18.10	
78119-0369	36	20.10	17.50	19.40	18.60	
78119-0379	37	20.60	18.00	19.90	19.10	
78119-0389	38	21.10	18.50	20.40	19.60	
78119-0399	39	21.60	19.00	20.90	20.10	
78119-0409	40	22.10	19.50	21.40	20.60	

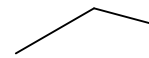

REVISED IEC NO: J2012-1253 DRW: KMIYAHARA 2012/03/23 CHK: KDKTAKAHASHI 2012/03/26 APPR: KMORI KAWA 2012/03/30	QUALITY SYMBOLS	GENERAL TOLERANCES (UNLESS SPECIFIED)		DIMENSION STYLE MM ONLY		SCALE NTS	DESIGN UNITS METRIC	THIRD ANGLE PROJECTION		
	▼ = 0 ▽ = 0	mm INCH 4 PLACES ± --- ± --- 3 PLACES ± --- ± --- 2 PLACES ± 0.15 ± --- 1 PLACE ± --- ± --- ANGULAR ± 3 °	DRAWN BY YLOIAO CHECKED BY BOKOK APPROVED BY PTLIM MATERIAL NO. SEE TABLE	DATE 2006/04/11 DATE 2006/04/18 DATE 2006/04/18	TITLE 0.50MM PITCH, FPC CONN. NON-ZIF, SMT		MOLEX INCORPORATED		DOCUMENT NO. SD-78119-001	
	DRAFT WHERE APPLICABLE MUST REMAIN WITHIN DIMENSIONS		THIS DRAWING CONTAINS INFORMATION THAT IS PROPRIETARY TO MOLEX INCORPORATED AND SHOULD NOT BE USED WITHOUT WRITTEN PERMISSION		SHEET NO. 4 OF 7					
	A3	REV								

10 9 8 7 6 5 4 3 2 1

EMBOSSED TYPE A

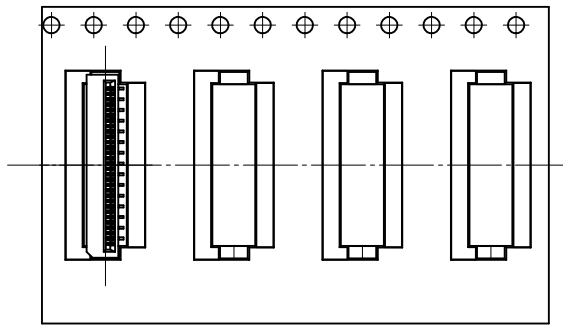

CUSTOMER
PULL OUT DIRECTION

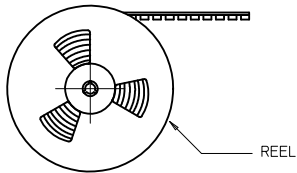

REEL

NOTES:

1. LEADER AND TRAILER TAPE

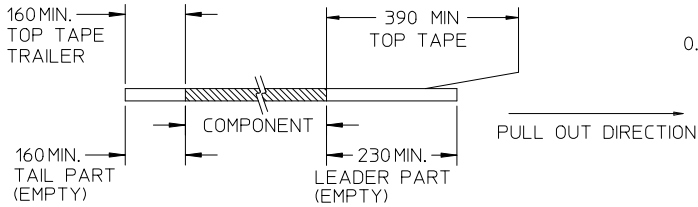

2. PEELING OFF FORCE OF THE TOP TAPE: 20-80gf.
(PEELING DIRECTION AS SHOWN IN FOLLOWING FIGURE)

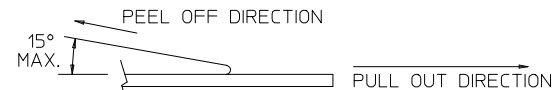

- 3. PACKAGING STANDARD IS AS PER EIA-481.
- 4. TAPE & REEL QUANTITY = 1000 PCS/REEL

EMBOSSED TYPE B

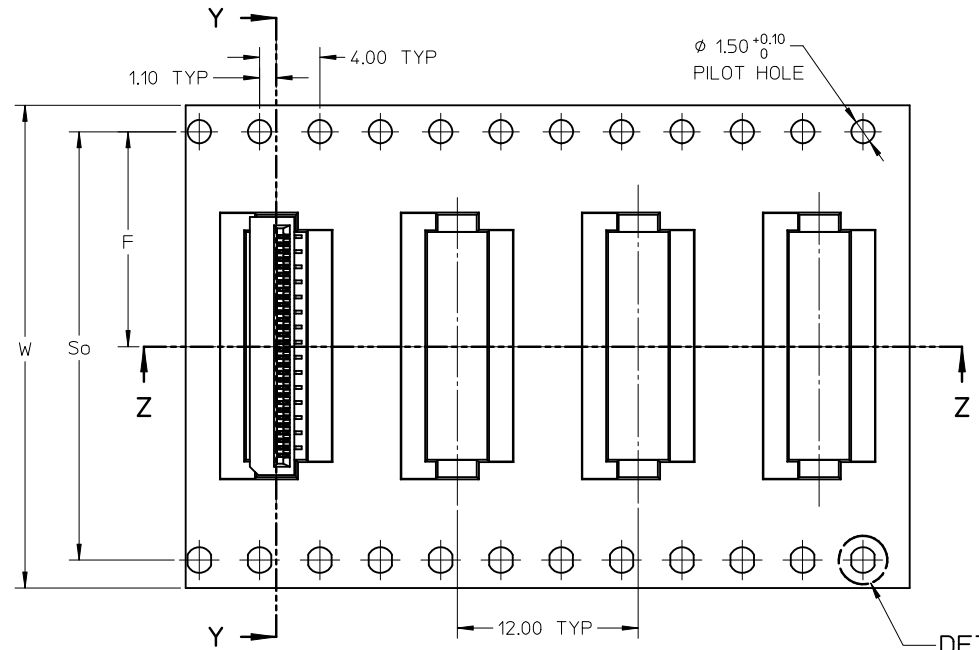

DETAIL 1

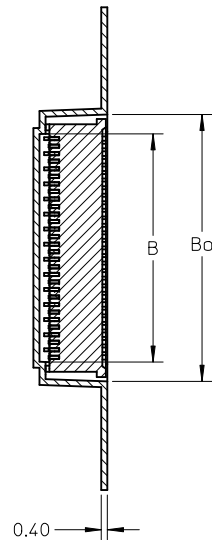

SECTION Y-Y

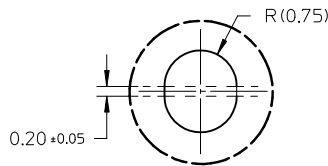

DETAIL 1

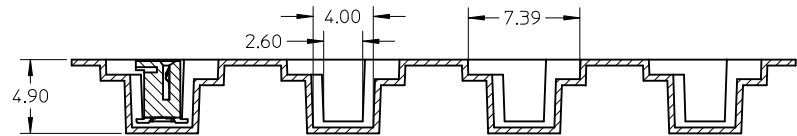

SECTION Z-Z

REVISED EC NO: J2012-1253 DR: NIKKI YAHARA 2012/03/23 CH: KDK TAKAHASHI 2012/03/26 APPR: KIMORI KAWA 2012/03/30	DESCRIPTION QUALITY SYMBOLS ▽=0 ◻=0	GENERAL TOLERANCES (UNLESS SPECIFIED)		DIMENSION STYLE MM ONLY	SCALE NTS	DESIGN UNITS METRIC	THIRD ANGLE PROJECTION		
		4 PLACES ± --- ± --- 3 PLACES ± --- ± --- 2 PLACES ± 0.15 ± --- 1 PLACE ± --- ± ---	mm INCH	DRAWN BY YLQIAO	DATE 2006/04/11	TITLE 0.50MM PITCH, FPC CONN. NON-ZIF, SMT			
		ANGULAR ± 3 °		CHECKED BY BOKOK	DATE 2006/04/18	MOLEX INCORPORATED			
		DRAFT WHERE APPLICABLE MUST REMAIN WITHIN DIMENSIONS		APPROVED BY PTLIM	DATE 2006/04/18	MATERIAL NO. SEE TABLE	DOCUMENT NO. SD-78119-001	SHEET NO. 5 OF 7	

9 8 7 6 5 4 3 2 1

GOLD PLATING TERMINAL ASSEMBLY PART NUMBERS

ASSY P/N PACKED IN T&R	ASSY P/N W/O PACKAGING	CKT	W	So	F	Bo	B	EMBOSSED TYPE
78119-1108	78119-0108	10	24.00	-	11.50	7.40	5.10	A
78119-1118	78119-0118	11	24.00	-	11.50	7.90	5.60	
78119-1128	78119-0128	12	24.00	-	11.50	8.40	6.10	
78119-1138	78119-0138	13	24.00	-	11.50	8.90	6.60	
78119-1148	78119-0148	14	24.00	-	11.50	9.40	7.10	
78119-1158	78119-0158	15	24.00	-	11.50	9.90	7.60	
78119-1168	78119-0168	16	24.00	-	11.50	10.40	8.10	
78119-1178	78119-0178	17	24.00	-	11.50	10.90	8.60	
78119-1188	78119-0188	18	24.00	-	11.50	11.40	9.10	
78119-1198	78119-0198	19	24.00	-	11.50	11.90	9.60	
78119-1208	78119-0208	20	24.00	-	11.50	12.40	10.10	
78119-1218	78119-0218	21	32.00	28.40	14.20	12.90	10.60	B
78119-1228	78119-0228	22	32.00	28.40	14.20	13.40	11.10	
78119-1238	78119-0238	23	32.00	28.40	14.20	13.90	11.60	
78119-1248	78119-0248	24	32.00	28.40	14.20	14.40	12.10	
78119-1258	78119-0258	25	32.00	28.40	14.20	14.90	12.60	
78119-1268	78119-0268	26	32.00	28.40	14.20	15.40	13.10	
78119-1278	78119-0278	27	32.00	28.40	14.20	15.90	13.60	
78119-1288	78119-0288	28	32.00	28.40	14.20	16.40	14.10	
78119-1298	78119-0298	29	32.00	28.40	14.20	16.90	14.60	
78119-1308	78119-0308	30	32.00	28.40	14.20	17.40	15.10	

ASSY P/N PACKED IN T&R	ASSY P/N W/O PACKAGING	CKT	W	So	F	Bo	B	EMBOSSED TYPE
78119-1318	78119-0318	31	32.00	28.40	14.20	17.90	15.60	B
78119-1328	78119-0328	32	32.00	28.40	14.20	18.40	16.10	
78119-1338	78119-0338	33	32.00	28.40	14.20	18.90	16.60	
78119-1348	78119-0348	34	32.00	28.40	14.20	19.40	17.10	
78119-1358	78119-0358	35	32.00	28.40	14.20	19.90	17.60	
78119-1368	78119-0368	36	32.00	28.40	14.20	20.40	18.10	
78119-1378	78119-0378	37	32.00	28.40	14.20	20.90	18.60	
78119-1388	78119-0388	38	32.00	28.40	14.20	21.40	19.10	
78119-1398	78119-0398	39	44.00	40.40	20.20	21.90	19.60	
78119-1408	78119-0408	40	44.00	40.40	20.20	22.40	20.10	

REVISED EC NO: J2012-1253 DRWN: KMIYAHARA 2012/03/23 CHKD: KTAHASHI 2012/03/26 APPR: KMORIKAWA 2012/03/30	QUALITY SYMBOLS =0 =0	GENERAL TOLERANCES (UNLESS SPECIFIED)		DIMENSION STYLE MM ONLY		SCALE NTS	DESIGN UNITS METRIC	THIRD ANGLE PROJECTION		
			mm	INCH	DRAWN BY YLOIAO	DATE 2006/04/11	TITLE 0.50MM PITCH, FPC CONN. NON-ZIF, SMT			
		4 PLACES	± ---	± ---	CHECKED BY BOKOK	DATE 2006/04/18				
		3 PLACES	± ---	± ---	APPROVED BY PTL IM	DATE 2006/04/18	MOLEX INCORPORATED DOCUMENT NO. SD-78119-001 SHEET NO. 6 OF 7			
2 PLACES	± 0.15	± ---	MATERIAL NO.							
1 PLACE	± ---	± ---	DRAFT WHERE APPLICABLE MUST REMAIN WITHIN DIMENSIONS		SEE TABLE		THIS DRAWING CONTAINS INFORMATION THAT IS PROPRIETARY TO MOLEX INCORPORATED AND SHOULD NOT BE USED WITHOUT WRITTEN PERMISSION			

TIN-BISMUTH PLATING TERMINAL ASSEMBLY PART NUMBERS

ASSY P/N PACKED IN T&R	ASSY P/N W/O PACKAGING	CKT	W	So	F	Bo	B	EMBOSSSED TYPE
78119-1109	78119-0109	10	24.00	-	11.50	7.40	5.10	A
78119-1119	78119-0119	11	24.00	-	11.50	7.90	5.60	
78119-1129	78119-0129	12	24.00	-	11.50	8.40	6.10	
78119-1139	78119-0139	13	24.00	-	11.50	8.90	6.60	
78119-1149	78119-0149	14	24.00	-	11.50	9.40	7.10	
78119-1159	78119-0159	15	24.00	-	11.50	9.90	7.60	
78119-1169	78119-0169	16	24.00	-	11.50	10.40	8.10	
78119-1179	78119-0179	17	24.00	-	11.50	10.90	8.60	
78119-1189	78119-0189	18	24.00	-	11.50	11.40	9.10	
78119-1199	78119-0199	19	24.00	-	11.50	11.90	9.60	
78119-1209	78119-0209	20	24.00		11.50	12.40	10.10	
78119-1219	78119-0219	21	32.00	28.40	14.20	12.90	10.60	
78119-1229	78119-0229	22	32.00	28.40	14.20	13.40	11.10	
78119-1239	78119-0239	23	32.00	28.40	14.20	13.90	11.60	
78119-1249	78119-0249	24	32.00	28.40	14.20	14.40	12.10	
78119-1259	78119-0259	25	32.00	28.40	14.20	14.90	12.60	
78119-1269	78119-0269	26	32.00	28.40	14.20	15.40	13.10	
78119-1279	78119-0279	27	32.00	28.40	14.20	15.90	13.60	
78119-1289	78119-0289	28	32.00	28.40	14.20	16.40	14.10	
78119-1299	78119-0299	29	32.00	28.40	14.20	16.90	14.60	
78119-1309	78119-0309	30	32.00	28.40	14.20	17.40	15.10	

ASSY P/N PACKED IN T&R	ASSY P/N W/O PACKAGING	CKT	W	So	F	Bo	B	EMBOSSSED TYPE
78119-1319	78119-0319	31	32.00	28.40	14.20	17.90	15.60	
78119-1329	78119-0329	32	32.00	28.40	14.20	18.40	16.10	
78119-1339	78119-0339	33	32.00	28.40	14.20	18.90	16.60	
78119-1349	78119-0349	34	32.00	28.40	14.20	19.40	17.10	
78119-1359	78119-0359	35	32.00	28.40	14.20	19.90	17.60	
78119-1369	78119-0369	36	32.00	28.40	14.20	20.40	18.10	
78119-1379	78119-0379	37	32.00	28.40	14.20	20.90	18.60	
78119-1389	78119-0389	38	32.00	28.40	14.20	21.40	19.10	
78119-1399	78119-0399	39	44.00	40.40	20.20	21.90	19.60	
78119-1409	78119-0409	40	44.00	40.40	20.20	22.40	20.10	

REVISED EC NO: J2012-1253 DRW:KMI YAHARA 2012/03/23 CHKD:KTAHASHI 2012/03/26 APPR:KMORIKAWA 2012/03/30	QUALITY SYMBOLS	GENERAL TOLERANCES (UNLESS SPECIFIED)	DIMENSION STYLE	SCALE	DESIGN UNITS	THIRD ANGLE PROJECTION
	▽=0 C=0	mm INCH 4 PLACES ± --- ± --- 3 PLACES ± --- ± --- 2 PLACES ± 0.15 ± --- 1 PLACE ± --- ± --- ANGULAR ± 3 °	MM ONLY	NTS	METRIC	
	DESCRIPTION	DRAFT WHERE APPLICABLE MUST REMAIN WITHIN DIMENSIONS	DRAWN BY DATE YLQIAO 2006/04/11 CHECKED BY DATE BOKOK 2006/04/18 APPROVED BY DATE PTLIM 2006/04/18 MATERIAL NO.	TITLE	0.50MM PITCH, FPC CONN. NON-ZIF, SMT	
	REV	SIZE	SEE TABLE	MOLEX INCORPORATED DOCUMENT NO. SD-78119-001		SHEET NO. 7 OF 7