





金龙机电股份有限公司  
**JINLONG MACHINERY & ELECTRONICS CO., LTD.**  
 www.jinlong-machinery.com  
 sales@jinlong-machinery.com

## 规格书

### *SPECIFICATION*

客户信息	客户名称/Customer	
	客户料号/Part No.	
	客户承认签章 Customer Approved Signatures	

文件编号/Spec No.		
品名/Description	圆柱直流马达/Cylindrical DC motor	
型号/Part No.	ZJP08-74D160A	
设计/Designed	审核/Checked	批准/Approved
		
<b>2009.05.12</b>	<b>2009.05.12</b>	<b>2009.05.12</b>

# JP08-74D160A

## 1. Standard Operating Conditions

### 标准使用条件

1—1	Rated Voltage 额定电压	4.5V DC CONSTANT between motor terminals 电机端子间加 4.5V DC
1—2	Operating Voltage Range 使用电压范围	1.8V-6.0V DC CONSTANT between motor terminals 1.8V-6.0V DC (电机端子间)
1—3	Rated Load 额定负载	2.2g-cm by pulley load 2.2g-cm (力矩盘负载)
1—4	Direction of Rotation 旋转方向	CW & CCW viewed from protruded shaft side 从轴伸端看进去为顺时针或逆时针方向
1—5	Radial force 径向力	Less than 100g measured at bearing of protruded shaft side (Distance of both bearings is 11.5mm) 从出力轴端测小于 100g. (二轴承间距为 11.5mm)
1—6	Operating temperature 工作温度	-30°C- +85°C
1—7	Storage temperature 贮存温度	-40°C- +85°C
1—8	Motor position 电机姿势	All direction of protruded shaft 出力轴全方向

## 2. Measuring Conditions 测试条件

2—1	Motor Position 电机姿势	Motor to be held, with shaft horizontally 出力轴水平
2—2	Power supply 电源	Regulated power supply which assures unquestionable measurement 可调节直流稳压电源, 保证测量时无疑问
2—3	Temperature and humidity 温度和湿度	10 °C --30 °C , 30%--95%. If the judgment is questionable, measurement is to be made based on JIS standard testing condition (20°C ±2°C, 65% ±5%) 原则上为 10°C-30°C, 30%--95%, 如果判断有疑问, 按 JIS 测试标准 (20°C ±2°C, 65% ±5%)

### 3. Electrical Characteristics

#### 电气性能

3-1	No Load Current 空载电流	Rated voltage . No Load 额定电压. 空载	50mA max
3-2	No Load Speed 空载转速	Rated Voltage. NO load 额定电压. 空载	23000±10%rpm
3-3	Rated Load Current 额定负载电流	Ragulated power supply which assures 3.0V DC constant between motor terminal, rated load 调节电缘使得电机端电压为 3.0V DC, 额定负载	200mA max
3-4	Rated Load Speed 额定负载转速	Ragulated power supply which assures 3.0V DC constant between motor terminal, rated load 调节电缘使得电机端电压为 3.0V DC, 额定负载	15000±10%rpm
3-5	Starting Voltage 始动电压	NO load 空载时	1.5V max
3-6	Starting Torque 起动力矩	Rated Voltage . by pulley Load 额定电压. 挂法码方式	6.0g-cm min
3-7	Starting Current 起动电流	Rated Voltage, rotor position to be 2/3R 额定电压下, 转子位置 2/3R 处	500mA max
3-8	Insulation Resistance 绝缘电阻	DC 100V between motor terminal and motor metal housing 电机出线端和电机机壳间加 100v 电压	1MΩ min
3-9	Rotor Resistance 转子电阻	At 20°C, rotor position to be 2/3R 在 20°C 时, 转子位置处于 2/3R 处	10±10%Ω
3-10	Electrical Noise 电气噪音	Motor to be equipped with varistor 电机已装有噪音抑制元件—压敏电阻	
3-11	Reference Curve 参考曲线	See page 11 见第 11 页图面	

## 4. External & Functional Characteristics

### 结构及机械性能

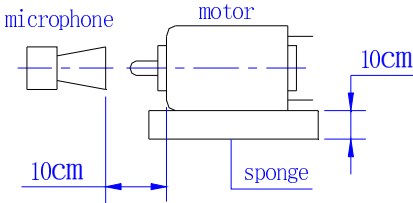
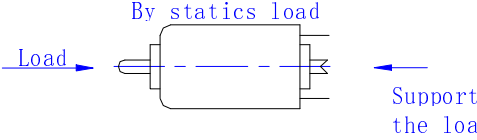
4-1	External appearance 外观	Outer dimensions to be within the tolerances specified in the attached Drawing NO. Page12.No remarkable deformation or superficial defects to be observed by visual check. Fastened parts to be fixed firmly. 外形尺寸符合第 12 页图面,外观应无明显变形或表面拉伤,紧固件应安装牢固.	
4-2	Shaft end play 轴向间隙	End play for thrust direction of protruded shaft. 向轴伸方向拉动出力轴.	0.02-0.30mm
4-3	Shaft T.I.R 轴径向跳动	At 3.0mm away from the mounting surface 距机壳端面 3.0mm 处	0.03mm max
4-4	Weight 重量		About 3.4g 约 3.4g
4-5	Vibration 振动	To be set with mutual 经用户确认同意	
4-6	Mechanical noise 机械噪音	Rated voltage, no load, and motor horizontally held, measured by JIS-A(RMS), at 10cm away from metal housing on protruded side, and back ground noise to be 23dB(max), clearance noise when if disappear with 50g radial force onto shaft to be excluded. 额定电压、空载,电机水平放置(见下图)按 JIS-A(RMS) 测试,测试时排除间隙噪音,方法为在轴上加 50g 径向力,背景噪音不大于 23dB 	55 dB max
4-7	Maximum Axial Load 最大轴向力	Direction of static load and support of load as shown below 轴向静推力和支撑位置的方向如下图 	10kg max

## 5. Environmental Tests.

### 环境试验。

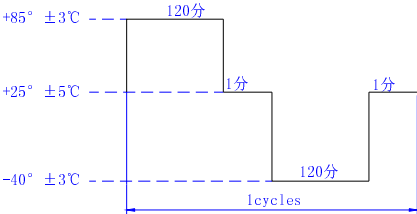
5-1	Vibration Test 振动试验	All of the specifications in Item 3 and 4 are to be satisfied after motor is subjected to the sine wave of 2 mm amplitude and 1000CPM in the three directions for 30 minutes each. 电机在 X、Y、Z 三个方向经过振幅为 2 mm, 1000 CPM 的正弦波扫描振动各 30 分钟后 3 和 4 的性能指标不变。
5-2	Shock Test 冲击试验	All of the specifications in Item 3 and 4 are to be satisfied after motor should be withstand 6 one haft sine wave shocks per axis(x, y, z), peak acceleration is 30G, plus width is 11ms. 电机在 X、Y、Z 三个方向经过 6 个正弦半波, 加速度为 30G, 作用 11ms 后电机 3 和 4 性能指标不变。
5-3	Storage Test under high temperature 高温放置试验	All of the specifications in Item 3 and 4 are to be satisfied after motors exposed to $+85\pm 3^{\circ}\text{C}$ for 96 hours, and then to temperature/humidity of Item 2-3 for 24hours. 电机放于 $+85^{\circ}\text{C}$ 环境中 96 小时, 再在常温、常湿下放置 24 小时, 电机性能 3 和 4 的指标不变。
5-4	Storage Test under low temperature 低温放置试验	All of the specifications in Item 3 and 4 are to be satisfied after motors exposed to $-40\pm 3^{\circ}\text{C}$ for 96 hours, and then to temperature/humidity of Item 2-3 for 24 hours. 电机放于 $-40^{\circ}\text{C}$ 环境中 96 小时, 再在常温、常湿下放置 24 小时, 电机性能 3 和 4 的指标不变。
5-5	Storage Test Under high temperature / humidity 高温、高湿 储存试验	All of the specifications in Item 3 and 4 are to be satisfied after motors exposed to $+60\pm 3^{\circ}\text{C} / 90\%-95\% \text{ RH}$ for 192 hours, and then to temperature/humidity of Item 2-3 for 24 hours. 电机放于 $+60^{\circ}\text{C}$ 相对湿度为 90%-95% 的环境中 192 小时, 再在常温、常湿下放置 24 小时, 电机性能 3 和 4 的指标不变。
5-6	Shocked test by low / high temperature 冷热冲击试验	All of the specifications in Item 3 and 4 are to be satisfied after motors exposed to 5 cycles at duty cycle of temperature (as sketched) and then to temperature/humidity of Item 2-3 for 24 hours. 电机在下列周期条件下经过 5 个周期后, 再在常温、常下放置 24 小时后, 电机性能 3 和 4 的指标不变。 

## 6. Life Test 寿命试验

6-1	Continuous running (at 25°C ± 5°C) 常温连续	Environmental condition: 25°C ± 5°C / 65% ± 20% RH, Equipped eccentric wheel. Cycle condition as below: 环境条件: 25°C ± 5°C / 65% ± 20% RH 装上分铜, 下列条件测试	150H min
-----	---	---	-------------

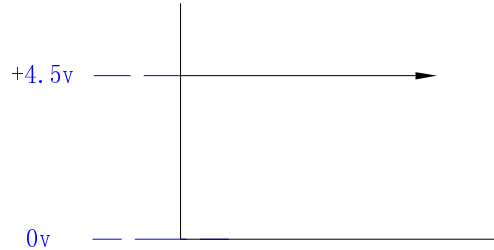

6-2	Intermittent running (at 25°C ± 5°C) 常温断续	Environmental condition: 25°C ± 5°C / 65% ± 20% RH, Equipped eccentric wheel. Cycle condition as below: 环境条件: 25°C ± 5°C / 65% ± 20% RH 装上分铜, 下列条件测试	50000cycles min
-----	---	---	--------------------

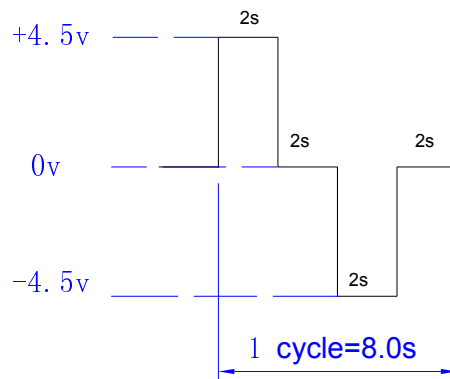

Before / After life test, measuring the rated load specification. Motor life is judged to come to an end when.

寿命试验前后测定电机的额定负载特性, 出现下列情况之一时判为寿命终止:

(1) Rated-load speed gets varied over  $\pm 35\%$  against the initial figure.

额定负载转速超过初始值的  $\pm 35\%$

(2) Rated-Load Current gets varied over +40% against the initial figure.

额定负载电流超过初始值的 +40%

(3) Motor is unquestionable recognized as unusable.

当电机出现异常被确认无疑时

## 7. Rejects: 拒收

Motors which do not meet with the specifications mentioned above or which are apparently judged as faulty due to poor workman ship

当电机性能不符合上述条件或制造上存在缺陷时, 电机被判为不良

## 8、Environment-related substance 环境物质：

The part should not contain any environment-related substance.

马达部品不含有任何的环境有害物质。

The details of use prohibition parts or exclusion items as below:

禁止使用的环境物质如下所示：

<b>(1) Heavy metals</b>	<b>重金属</b>
1) Cadmium and its compounds(Cd);	镉及其化合物 (<5ppm)
2) Lead and its compounds(Pb);	铅及其化合物 (<100ppm)
3) Mercury and its compounds(Hg);	汞及其化合物 (禁止含有)
4) Hexavalent chromium compounds(Cr+6);	六价铬及其化合物 (禁止含有)
<b>(2) Chlorinated organic compounds</b>	<b>有机氯化物</b>
1) Polychlorinated biphenyls(PCBs);	多氯联苯 (禁止含有)
2) Polychlorinated terphenyls(PCTs);	多氯三联苯 (禁止含有)
3) Polychlorinated naphthalenes(PCNs);	多氯化萘 (禁止含有)
4) Short-chain chlorinated paraffins;	短链氯化石蜡(C: 10-13) (<1000ppm)
<b>(3) Brominated organic compounds</b>	<b>有机溴化合物</b>
1) Polybrominated biphenyls(PBBs);	多溴联苯 (禁止含有)
2) Polybrominated diphenylethers(PBDEs);	多溴二苯醚 (禁止含有)
3) Terabromobisphenol A(TBBP-A);	四溴双酚-A (<900ppm)
4) Hexabromocyclododecane (HBCDD)	六溴环十二烷 (<1000ppm)
<b>(4) Azo compounds</b>	<b>偶氮化合物 (&lt;30ppm)</b>
<b>(5) Ozone depleting substances;</b>	<b>破坏臭氧层的物质 (不使用)</b>
<b>(6) Asbestos</b>	<b>石棉 (不使用)</b>
<b>(7) Ni and compounds;</b>	<b>镍及其化合物 (0.5ug-Ni/cm<sup>2</sup>/周)</b>
<b>(8) Organic tin;</b>	<b>有机锡化合物 (不使用)</b>
<b>(9) Arsenic ;</b>	<b>砷及其化合物 (不使用)</b>
<b>(10) Perfluorooctane Sulfonates (PFOS) ;</b>	<b>全氟辛烷磺酰基化合物 (&lt;1000ppm)</b>
<b>(11) Brominated Flame Retardants;</b>	<b>溴类阻燃剂 (&lt;900ppm)</b>
<b>(12) Formaldehyde;</b>	<b>甲醛 (&lt;1000ppm)</b>

## 9、Precautions in using the motor 马达使用注意事项:

(1) If silicon materials, which contain low molecular silicon compounds, adhere to the motor's commutator, brush or other parts, then upon rectification of the electric energy the silicon breaks down into  $\text{SiO}_2$ ,  $\text{SiC}$  and other constituents which produce a rapid increase in the contact resistance between the commutator and brush. Therefore great care should be taken when silicon material is used in a unit and check well at the same time that such binding agents or sealing materials are not generating gases of detrimental nature, whether used for motor mounting or applied during your product assemblies. Care must be taken for an optimum selection, especially when using those of cyanic adhesive and sulfur gas.

如果马达部品或周边环境和物体中含有 Si、S 等微量元素时可能造成换向器与电刷间阻抗增加, 即形成氧化物, 使之不通电。

(2) When mounting your motors by means of binding agents, DON'T allow any adherence to the bearings nor intrusion into the motors.

马达安装后不充许有包装粘结到轴承或异物落入马达内。

(3) Axial thrust on the output shaft could have an adverse effect on the motor life .i.e. As is produced by worm gears, fans, etc.

Check the service life expected under the actual operating conditions by testing the motors installed in your application products. For heavy thrust loads, consider using something mechanical to retain the shaft end.

当蜗杆、风叶对马达轴有轴向猛推力时对马达寿命有影响, 应利用其它设施减少对马达轴向推拉力以保证其串量。

(4) There are occasions when the internal resistance of the motor driving power source (Which contains an electrical circuit) can influence the life span of the motor.

In instances where there is a low input of voltage to the motor, the internal resistance of the power source is large which may well result in an inferior motor after a short time, conversely in instances where high cyclic voltages are applied, this internal resistance is small and the motor life span is shortened. When the temperature deviates from the normal room temperature as is the case in low and high temperature situations, please note the conditions.

电源内阻偏大或偏小会导致马达运行不良或寿命减短, 另当温度高或低于室温情况下请记录环境温度。

(5) Motor life may be affected adversely by heavy radial load such as produced by rotating eccentric cams, etc., and also by vibration given from outside.

Do check over such negative factors by testing the motors to the actual operating conditions in your application products.

马达寿命在超负荷或非正常使用时所产生的不良结果, 我们不以确认。

(6) If when mounting the motor and assembling the unit, equipment which emits ultrasonic waves is used there is a danger that some of the internal parts of the motor might be damaged so please take care.

请注意马达组装后, 设备若发出超声波将对马达内部造成影响。

(7) DON'T store motors under environmental conditions of high temperature and extreme humidity.

DON'T keep them also in an atmosphere where corrosive gas may be present, as it may result in malfunction.

勿将马达储藏放置在高温高湿有腐蚀性气体处。

(8) Ambient and operating temperatures exert an affect more or less on motor performance and life.

Do pay particular attention the surroundings when it is hot and damp.

为防止工作环境的温度变化会影响到马达功能或寿命, 所以当天气湿热时请特别注意。

(9) When press fitting a pulley, gear etc., onto the motor output shaft, always support the shaft at the other end or its retaining metal pad in a proper and correct way.



安装滑轮或齿轮时请给马达轴正确方式定位，应将马达轴另一端即端盖轴承室用铁块顶住。

**(10)** When soldering, BE SURE to finish your work quickly so as not to develop plastic deformation around the motor terminals nor to give them any forced bend or inward depression. In doing so, special care must be taken not to allow solder debris and flux to spatter into motors and precautionary measures should be taken if necessary, by covering up all the nearby holes and apertures. Any motors having snap-in terminals must also be attended carefully so as not to get flux in along the terminals, as it may cause failure in electrical conduction.

当焊接时时间勿太长，不要让围绕端子的塑料件变形或使端子弯曲，需保证不能让焊接碎屑或焊锡熔化物进入马达内部。不得已时，须将塑料件附近的孔径或缝隙掩盖。任何马达均需保证焊锡熔化物不得顺端子进入其内部，否则可能会引起马达电气故障。

**(11)** DON'T leave motor shaft locked while power is applied, as even a short-time lock-up may cause excess heat build up resulting damage to the motor depending on its specifications.

切勿在马达接通电源时当马达轴堵住，这样可能会使马达温度升高而产生火灾。

**(12)** Intensive pressure on the endbell boss might cause starting disability of motor. So please take care for motor mounting not to push endbell boss.

If the endbell boss must be pushed, the load should be put on the center of the boss.

Please ask us for the suitable value of the load.

强烈的挤压端盖轴承室可能会造成马达无法转动。所以请尽量不要推盖板轴承室。

如果轴承室无法避免要被推压，请将负荷加于轴承室中心位置。

必要时请预先通知我们做上述评估。

**(13)** Please do not touch motor bearing as otherwise bearing oil will be drawn out, which might cause bearing noise.

请勿触摸马达轴承，否则轴承油被吸干容易引起燥音。

**(14)** When motor more than three months did not be used for need to note oil for bearings and confirm afresh.

当马达库存超过三个月未被使用时需重新给轴承注油并确认。

**(15)** Fumigant and its gas may affect motor performance. Then, motors shall not be exposed to fumigant and its gas, if fumigation shall be made for packaging material etc.

薰剂及其气体可能会影响马达正常运行。勿将马达暴露在薰剂或其气体中。如包装材料中可能含有薰剂。

**(16)** Identification marking drawn on motor housing with dyestuff marker may be blurred or may fade out when rubbing.

马达机壳上的捺印标识可能会慢慢褪色。

For more information, please contact us directly or through our sales and representative offices.

若有其它疑问，请直接联系我们或通过我们的销售、客服与我们联系。

## 10、Others

### 其它

1) Temperature of soldering Tip: 焊接温度

Soldering temperature and time must be 350°C (max).within 3 seconds.  
焊接时烙铁温度不超过 350°C，焊接时间不超过 3 秒。

2) Label means: 铭牌标记说明

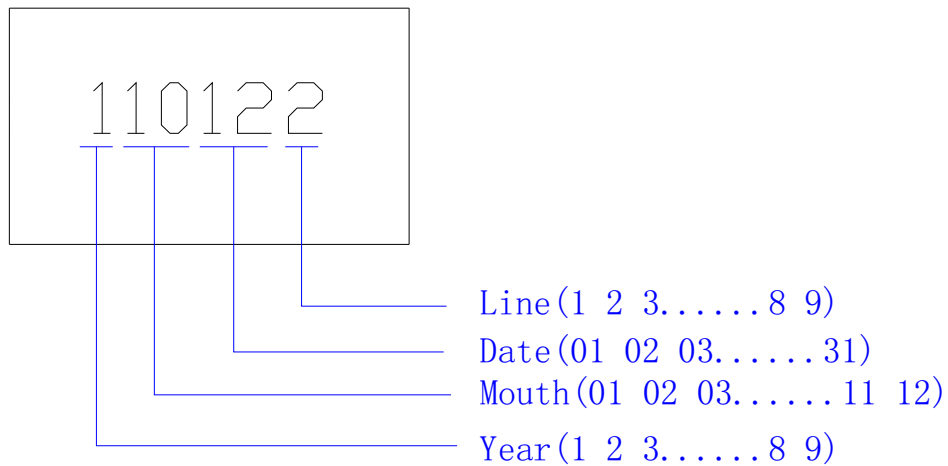

3) When machine material and method are changed, customers will be notified in advance.  
当设备、材料和工艺要做变动时，用户将会提前得到通知。

# JP08-74D160A DC brush motor characteristic curves

AT:25°C  
VOLTAGE:4.5V

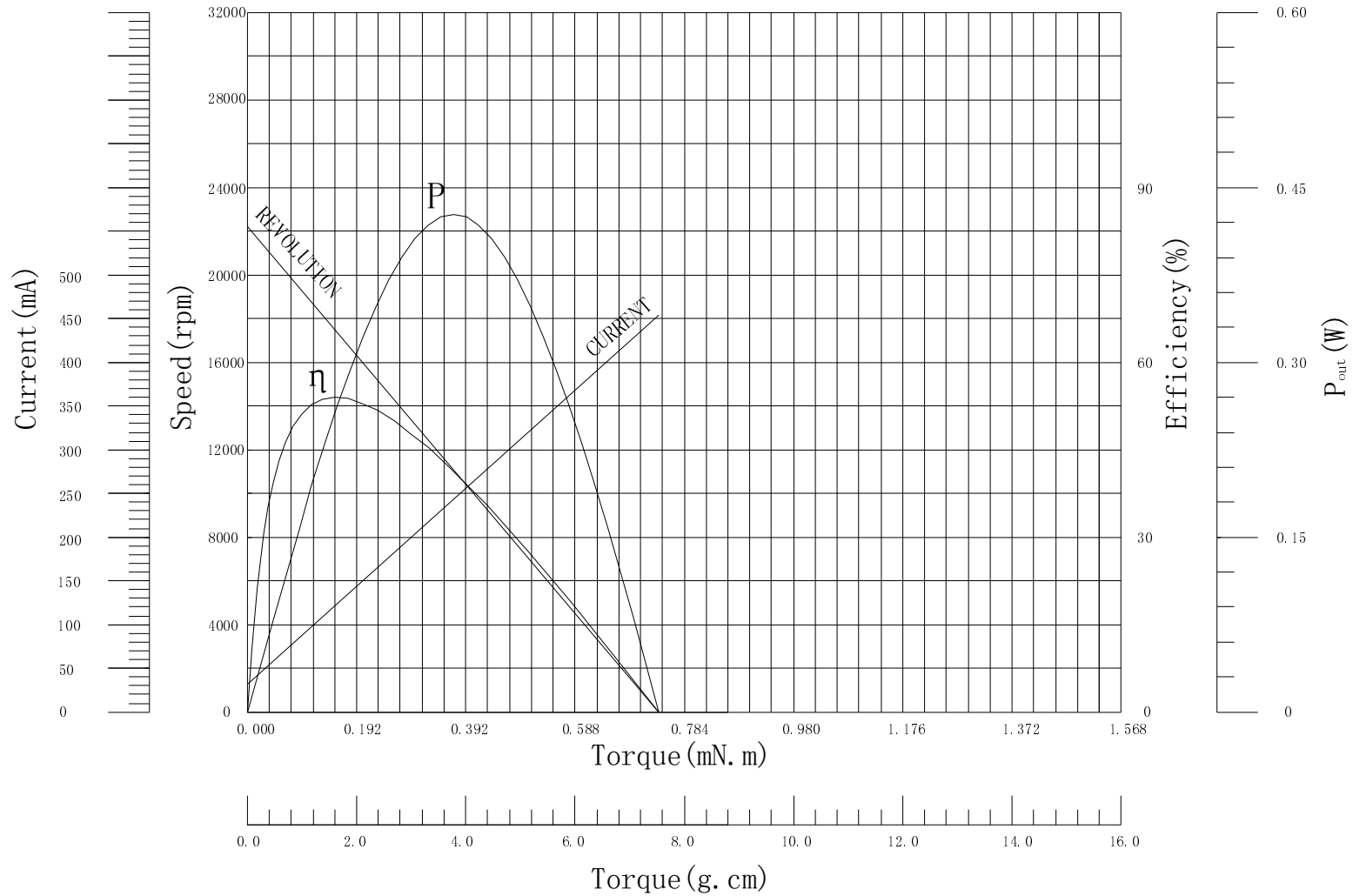

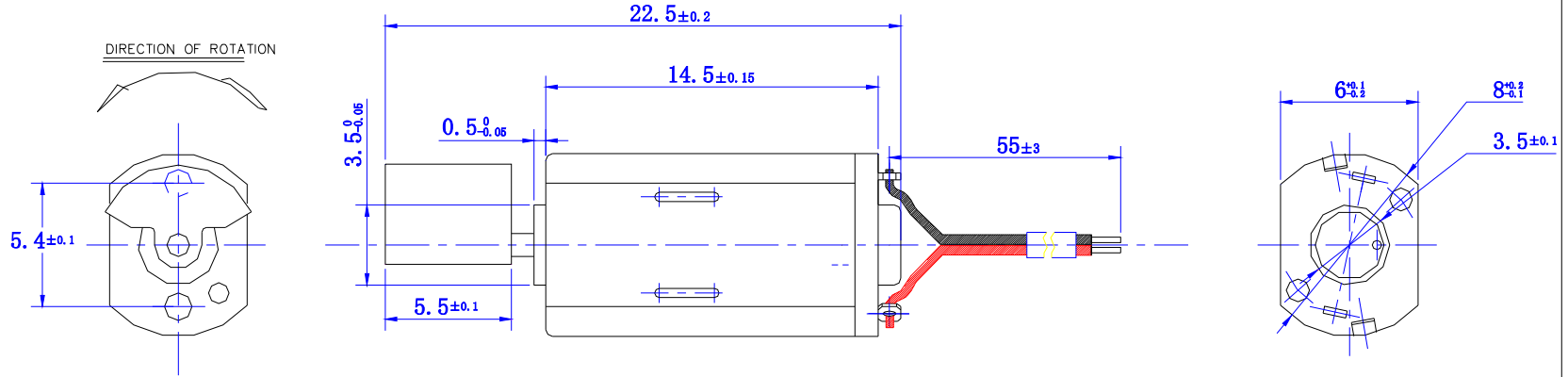

NOTES:

- 1, DIMENSION, MODIFICATIONS OR CHANGES NOT INDICATED ON THIS DRAWING DO NOT APPLY UNLESS CONFIRMED BY US IN WRITING.
- 2,  $7.0 \pm 0.3$  DIM. APPLIES ONLY WHEN MOTOR SHAFT IS IN EXTREME RIGHT POSITION.
- 3, SHAFT END PLAY 0.02-0.30.
- 4, USABLE MACHINE SCREW LENGTH 0.8 MAX. FROM MOTOR MOUNTING SURFACE.
- 5, ALLOWABLE TORQUE FOR SCREWING OF TAPPED HOLE: 196mN.m (2.0kgf-cm).
- 6, HOUSE MAKE, MOTOR TYPE, DATE TO BE PRINTED ON LABEL.
- 7, LABEL SHOULD BE PLACED ON AS SHOWN IN DRAWING.

更改标记	数量	更改单号	签名	日期
设计				
审核				
工艺				
标准化				
批准				

JP08-74D160A  
产品外形图

等级标记	重量	比例
		5:1
第 张	共 张	