

Notice for TAIYO YUDEN products

Please read this notice before using the TAIYO YUDEN products.

REMINDERS

- Product information in this catalog is as of October 2013. All of the contents specified herein are subject to change without notice due to technical improvements, etc. Therefore, please check for the latest information carefully before practical application or usage of the Products.

Please note that TAIYO YUDEN CO., LTD. shall not be responsible for any defects in products or equipment incorporating such products, which are caused under the conditions other than those specified in this catalog or individual specification.

- Please contact TAIYO YUDEN CO., LTD. for further details of product specifications as the individual specification is available.

- Please conduct validation and verification of products in actual condition of mounting and operating environment before commercial shipment of the equipment.

- All electronic components or functional modules listed in this catalog are developed, designed and intended for use in general electronics equipment.(for AV, office automation, household, office supply, information service, telecommunications, (such as mobile phone or PC) etc.). Before incorporating the components or devices into any equipment in the field such as transportation,(automotive control, train control, ship control), transportation signal, disaster prevention, medical, public information network (telephone exchange, base station) etc. which may have direct influence to harm or injure a human body, please contact TAIYO YUDEN CO., LTD. for more detail in advance.

Do not incorporate the products into any equipment in fields such as aerospace, aviation, nuclear control, submarine system, military, etc. where higher safety and reliability are especially required.

In addition, even electronic components or functional modules that are used for the general electronic equipment, if the equipment or the electric circuit require high safety or reliability function or performances, a sufficient reliability evaluation check for safety shall be performed before commercial shipment and moreover, due consideration to install a protective circuit is strongly recommended at customer's design stage.

- The contents of this catalog are applicable to the products which are purchased from our sales offices or distributors (so called "TAIYO YUDEN' s official sales channel").

It is only applicable to the products purchased from any of TAIYO YUDEN' s official sales channel.

- Please note that TAIYO YUDEN CO., LTD. shall have no responsibility for any controversies or disputes that may occur in connection with a third party's intellectual property rights and other related rights arising from your usage of products in this catalog. TAIYO YUDEN CO., LTD. grants no license for such rights.

- Caution for export

Certain items in this catalog may require specific procedures for export according to "Foreign Exchange and Foreign Trade Control Law" of Japan, "U.S. Export Administration Regulations", and other applicable regulations. Should you have any question or inquiry on this matter, please contact our sales staff.

RADIAL LEADED INDUCTORS



WAVE

■ PARTS NUMBER

*Operating Temp. : -25~+105°C (Including self-generated heat)

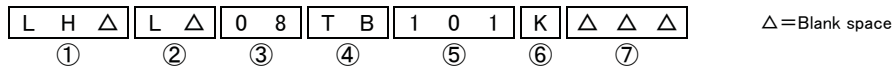

① Series name

Code	Series name
LH△	Radial leaded inductor

② Characteristics

Code	Characteristics
L△	Standard type Taping available
LP	Shielded type Bulk
LC	High current type

③ Dimensions (D)

Code	Dimensions (D) [mm max.]
08	9.0
10	11.0
12	13.0
13	14.0
16	17.0

④ Packaging

Code	Packaging
NB	Bulk (LHL)
TB	Ammo packaging (LHL)

⑤ Nominal inductance

Code (example)	Nominal inductance [μH]
1R0	1.0
150	15
102	1000

※R=Decimal point

⑥ Inductance tolerance

Code	Inductance tolerance
J	±5%
K	±10%
M	±20%
N	±30%

⑦ Internal code

Code	Internal code
△△△	Standard

INDUCTORS / LEADED INDUCTORS

■ STANDARD EXTERNAL DIMENSIONS / STANDARD QUANTITY

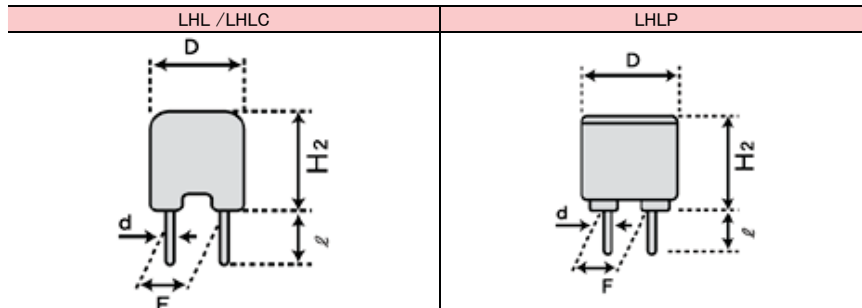

Type	D	H ₂	l	F	φ d	Standard quantity [pcs]		
						Box	Bulk	Taping
LH L 08	9.0 max	9.5 max	5.0±1.0	5.0±1.0	0.6±0.05	—	100	1000
LH LC08	(0.354 max)	(0.374 max)	(0.197±0.039)	(0.197±0.039)	(0.024±0.002)	—	100	1000
LH L 10	11.0 max	14.0 max	5.0±1.0	5.0±1.0	0.6±0.05	—	50	500
LH LC10	(0.433 max)	(0.551 max)	(0.197±0.039)	(0.197±0.039)	(0.024±0.002)	—	50	500
LH L 13	14.0 max	17.0 max	5.0±1.0	7.5±1.0	0.8±0.05	—	25	500
LH LC13	(0.551 max)	(0.669 max)	(0.197±0.039)	(0.295±0.039)	(0.031±0.002)	—	25	500
LH L 16	17.0 max	21.0 max	5.0±1.0	7.5±1.0	0.8±0.05	500	—	250
LH LC16	(0.669 max)	(0.827 max)	(0.197±0.039)	(0.295±0.039)	(0.031±0.002)	500	—	250
LH LP10	11.0 max	11.0 max	5.0±1.0	5.0±1.0	0.6±0.05	500	—	200
LH LP10	(0.433 max)	(0.433 max)	(0.197±0.039)	(0.197±0.039)	(0.024±0.002)	500	—	200
LH LP12	13.0 max	16.0 max	5.0±1.0	5.0±1.0	0.6±0.05	300	—	—
LH LP12	(0.512 max)	(0.624 max)	(0.197±0.039)	(0.197±0.039)	(0.024±0.002)	300	—	—
LH LP16	17.0 max	19.0 max	5.0±1.0	7.5±1.0	0.8±0.05	200	—	—
LH LP16	(0.669 max)	(0.741 max)	(0.197±0.039)	(0.295±0.039)	(0.031±0.002)	200	—	—

Unit : mm (inch)

▶ This catalog contains the typical specification only due to the limitation of space. When you consider the purchase of our products, please check our specification. For details of each product (characteristics graph, reliability information, precautions for use, and so on), see our Web site (<http://www.ty-top.com/>).

● LHL08

Parts number	EHS	Nominal inductance [μ H]	Inductance tolerance	Q (min.)	Self-resonant frequency [MHz] (min.)	DC Resistance [Ω] (max.)	Rated current [A] (max.)	Measuring frequency [MHz]
LH L 08□1R0N	RoHS	1.0	±30%	40	76	0.013	4.7	7.96
LH L 08□1R5M	RoHS	1.5	±20%	40	65	0.014	4.4	7.96
LH L 08□2R2M	RoHS	2.2	±20%	40	56	0.017	4.1	7.96
LH L 08□2R7M	RoHS	2.7	±20%	40	48	0.019	3.5	7.96
LH L 08□3R3M	RoHS	3.3	±20%	40	41	0.021	3.2	7.96
LH L 08□3R9M	RoHS	3.9	±20%	40	33	0.024	3.1	7.96
LH L 08□4R7M	RoHS	4.7	±20%	40	30	0.025	3.0	7.96
LH L 08□5R6M	RoHS	5.6	±20%	40	23	0.028	2.9	7.96
LH L 08□6R8M	RoHS	6.8	±20%	40	21	0.030	2.8	7.96
LH L 08□8R2M	RoHS	8.2	±20%	40	19	0.034	2.5	7.96
LH L 08□100K	RoHS	10	±10%	65	17	0.041	2.4	2.52
LH L 08□120K	RoHS	12	±10%	65	16	0.044	2.3	2.52
LH L 08□150K	RoHS	15	±10%	50	13	0.053	2.0	2.52
LH L 08□180K	RoHS	18	±10%	50	12	0.060	1.9	2.52
LH L 08□220K	RoHS	22	±10%	50	11	0.068	1.8	2.52
LH L 08□270K	RoHS	27	±10%	50	10	0.091	1.5	2.52
LH L 08□330K	RoHS	33	±10%	40	8.8	0.10	1.4	2.52
LH L 08□390K	RoHS	39	±10%	40	8.4	0.12	1.3	2.52
LH L 08□470K	RoHS	47	±10%	40	8.2	0.15	1.2	2.52
LH L 08□560K	RoHS	56	±10%	40	7.9	0.17	1.1	2.52
LH L 08□680K	RoHS	68	±10%	35	7.0	0.20	1.0	2.52
LH L 08□820K	RoHS	82	±10%	35	6.5	0.22	0.90	2.52
LH L 08□101K	RoHS	100	±10%	25	5.7	0.32	0.79	0.796
LH L 08□121K	RoHS	120	±10%	25	5.2	0.36	0.70	0.796
LH L 08□151K	RoHS	150	±10%	20	4.7	0.41	0.64	0.796
LH L 08□181K	RoHS	180	±10%	35	4.2	0.66	0.60	0.796
LH L 08□221K	RoHS	220	±10%	35	3.7	0.73	0.53	0.796
LH L 08□271K	RoHS	270	±10%	25	3.5	0.85	0.51	0.796
LH L 08□331K	RoHS	330	±10%	25	3.2	0.97	0.44	0.796
LH L 08□391K	RoHS	390	±10%	20	2.9	1.1	0.41	0.796
LH L 08□471K	RoHS	470	±10%	25	2.4	1.3	0.38	0.796
LH L 08□561K	RoHS	560	±10%	25	2.2	1.5	0.35	0.796
LH L 08□681K	RoHS	680	±10%	25	2.0	1.8	0.32	0.796
LH L 08□821K	RoHS	820	±10%	30	1.6	2.3	0.30	0.796
LH L 08□102J	RoHS	1000	±5%	55	1.5	2.7	0.25	0.252
LH L 08□122J	RoHS	1200	±5%	45	1.4	3.2	0.22	0.252
LH L 08□152J	RoHS	1500	±5%	55	1.3	4.1	0.20	0.252
LH L 08□182J	RoHS	1800	±5%	55	1.2	4.8	0.19	0.252
LH L 08□222J	RoHS	2200	±5%	55	1.1	5.6	0.16	0.252
LH L 08□272J	RoHS	2700	±5%	55	1.0	7.5	0.15	0.252
LH L 08□332J	RoHS	3300	±5%	55	0.85	8.5	0.14	0.252
LH L 08□392J	RoHS	3900	±5%	55	0.78	9.7	0.11	0.252
LH L 08□472J	RoHS	4700	±5%	65	0.68	14	0.10	0.252
LH L 08□562J	RoHS	5600	±5%	65	0.62	16	0.093	0.252
LH L 08□682J	RoHS	6800	±5%	65	0.61	18	0.092	0.252
LH L 08□822J	RoHS	8200	±5%	65	0.60	20	0.084	0.252
LH L 08□103J	RoHS	10000	±5%	60	0.48	32	0.070	L: 1kHz, Q: 0.0796MHz
LH L 08□123J	RoHS	12000	±5%	60	0.44	36	0.064	L: 1kHz, Q: 0.0796MHz
LH L 08□153J	RoHS	15000	±5%	60	0.35	62	0.051	L: 1kHz, Q: 0.0796MHz
LH L 08□183J	RoHS	18000	±5%	60	0.30	72	0.048	L: 1kHz, Q: 0.0796MHz
LH L 08□223J	RoHS	22000	±5%	60	0.28	82	0.044	L: 1kHz, Q: 0.0796MHz
LH L 08□273J	RoHS	27000	±5%	60	0.25	90	0.042	L: 1kHz, Q: 0.0796MHz
LH L 08□333J	RoHS	33000	±5%	60	0.23	100	0.040	L: 1kHz, Q: 0.0796MHz

□ Please specify the packaging code. (TB: Taping, NB: Bulk)

● LHL10

Parts number	EHS	Nominal inductance [μ H]	Inductance tolerance	Q (min.)	Self-resonant frequency [MHz] (min.)	DC Resistance [Ω] (max.)	Rated current [A] (max.)	Measuring frequency [MHz]
LH L 10□3R3M	RoHS	3.3	±20%	50	46	0.019	4.2	7.96
LH L 10□3R9M	RoHS	3.9	±20%	50	40	0.022	4.1	7.96
LH L 10□4R7M	RoHS	4.7	±20%	50	38	0.024	4.0	7.96
LH L 10□5R6M	RoHS	5.6	±20%	50	34	0.025	3.8	7.96
LH L 10□6R8M	RoHS	6.8	±20%	50	30	0.028	3.4	7.96
LH L 10□8R2M	RoHS	8.2	±20%	50	24	0.031	3.3	7.96
LH L 10□100K	RoHS	10	±10%	90	19	0.034	3.2	2.52
LH L 10□120K	RoHS	12	±10%	90	16	0.038	2.8	2.52
LH L 10□150K	RoHS	15	±10%	90	12	0.042	2.6	2.52
LH L 10□180K	RoHS	18	±10%	90	9.2	0.046	2.4	2.52
LH L 10□220K	RoHS	22	±10%	60	8.6	0.061	2.1	2.52
LH L 10□270K	RoHS	27	±10%	60	7.1	0.069	2.0	2.52
LH L 10□330K	RoHS	33	±10%	60	6.8	0.078	1.9	2.52
LH L 10□390K	RoHS	39	±10%	60	6.7	0.085	1.8	2.52
LH L 10□470K	RoHS	47	±10%	50	6.2	0.093	1.7	2.52
LH L 10□560K	RoHS	56	±10%	50	5.2	0.10	1.6	2.52
LH L 10□680K	RoHS	68	±10%	40	4.9	0.12	1.5	2.52
LH L 10□820K	RoHS	82	±10%	40	4.7	0.13	1.4	2.52
LH L 10□101K	RoHS	100	±10%	40	3.8	0.18	1.2	0.796
LH L 10□121K	RoHS	120	±10%	40	3.2	0.25	1.0	0.796
LH L 10□151K	RoHS	150	±10%	40	2.9	0.29	0.95	0.796
LH L 10□181K	RoHS	180	±10%	40	2.6	0.40	0.80	0.796
LH L 10□221K	RoHS	220	±10%	40	2.3	0.44	0.75	0.796
LH L 10□271K	RoHS	270	±10%	30	2.1	0.50	0.70	0.796
LH L 10□331K	RoHS	330	±10%	30	2.0	0.56	0.68	0.796
LH L 10□391K	RoHS	390	±10%	30	1.8	0.62	0.63	0.796
LH L 10□471K	RoHS	470	±10%	30	1.7	0.84	0.57	0.796
LH L 10□561K	RoHS	560	±10%	30	1.5	0.93	0.52	0.796
LH L 10□681K	RoHS	680	±10%	30	1.4	1.0	0.48	0.796
LH L 10□821K	RoHS	820	±10%	30	1.3	1.4	0.42	0.796
LH L 10□102J	RoHS	1000	±5%	50	1.2	1.8	0.41	0.252
LH L 10□122J	RoHS	1200	±5%	50	0.87	2.3	0.33	0.252
LH L 10□152J	RoHS	1500	±5%	50	0.83	2.7	0.30	0.252
LH L 10□182J	RoHS	1800	±5%	50	0.75	3.0	0.29	0.252
LH L 10□222J	RoHS	2200	±5%	50	0.70	3.9	0.25	0.252
LH L 10□272J	RoHS	2700	±5%	50	0.67	4.3	0.24	0.252
LH L 10□332J	RoHS	3300	±5%	50	0.56	5.8	0.21	0.252
LH L 10□392J	RoHS	3900	±5%	50	0.54	6.4	0.20	0.252
LH L 10□472J	RoHS	4700	±5%	50	0.49	7.1	0.19	0.252
LH L 10□562J	RoHS	5600	±5%	50	0.41	9.0	0.17	0.252
LH L 10□682J	RoHS	6800	±5%	50	0.38	10	0.16	0.252
LH L 10□822J	RoHS	8200	±5%	50	0.36	12	0.15	0.252
LH L 10□103J	RoHS	10000	±5%	60	0.29	19	0.12	L: 1kHz, Q: 0.0796MHz
LH L 10□123J	RoHS	12000	±5%	60	0.27	21	0.11	L: 1kHz, Q: 0.0796MHz
LH L 10□153J	RoHS	15000	±5%	60	0.24	34	0.090	L: 1kHz, Q: 0.0796MHz
LH L 10□183J	RoHS	18000	±5%	60	0.21	38	0.081	L: 1kHz, Q: 0.0796MHz
LH L 10□223J	RoHS	22000	±5%	60	0.20	43	0.075	L: 1kHz, Q: 0.0796MHz
LH L 10□273J	RoHS	27000	±5%	40	0.15	67	0.060	L: 1kHz, Q: 0.0796MHz
LH L 10□333J	RoHS	33000	±5%	40	0.14	76	0.056	L: 1kHz, Q: 0.0796MHz
LH L 10□393J	RoHS	39000	±5%	40	0.13	84	0.053	L: 1kHz, Q: 0.0796MHz
LH L 10□473J	RoHS	47000	±5%	40	0.12	96	0.050	L: 1kHz, Q: 0.0796MHz
LH L 10□563J	RoHS	56000	±5%	30	0.10	170	0.036	L: 1kHz, Q: 0.0796MHz
LH L 10□683J	RoHS	68000	±5%	30	0.095	200	0.035	L: 1kHz, Q: 0.0796MHz
LH L 10□823J	RoHS	82000	±5%	30	0.088	210	0.033	L: 1kHz, Q: 0.0796MHz
LH L 10□104J	RoHS	100000	±5%	30	0.085	240	0.031	L: 1kHz, Q: 0.0252MHz
LH L 10□124J	RoHS	120000	±5%	30	0.070	260	0.030	L: 1kHz, Q: 0.0252MHz
LH L 10□154J	RoHS	150000	±5%	30	0.069	300	0.028	L: 1kHz, Q: 0.0252MHz

● LHL13

Parts number	EHS	Nominal inductance [μ H]	Inductance tolerance	Q (min.)	Self-resonant frequency [MHz] (min.)	DC Resistance [Ω] (max.)	Rated current [A] (max.)	Measuring frequency [MHz]
LH L 13□100K	RoHS	10	±10%	140	19	0.023	4.5	2.52
LH L 13□150K	RoHS	15	±10%	140	12	0.028	4.0	2.52
LH L 13□220K	RoHS	22	±10%	100	7.6	0.035	3.4	2.52
LH L 13□330K	RoHS	33	±10%	100	6.9	0.043	3.2	2.52
LH L 13□470K	RoHS	47	±10%	70	5.6	0.052	2.8	2.52
LH L 13□680K	RoHS	68	±10%	50	4.4	0.070	2.4	2.52
LH L 13□101K	RoHS	100	±10%	50	3.3	0.12	2.0	0.796
LH L 13□151K	RoHS	150	±10%	50	2.6	0.19	1.5	0.796
LH L 13□221K	RoHS	220	±10%	40	2.2	0.23	1.3	0.796
LH L 13□331K	RoHS	330	±10%	30	1.8	0.35	1.1	0.796
LH L 13□471K	RoHS	470	±10%	30	1.5	0.43	0.90	0.796
LH L 13□681K	RoHS	680	±10%	30	1.2	0.61	0.80	0.796
LH L 13□102J	RoHS	1000	±5%	30	1.0	1.2	0.60	0.252
LH L 13□152J	RoHS	1500	±5%	40	0.83	1.8	0.45	0.252
LH L 13□222J	RoHS	2200	±5%	40	0.70	2.2	0.40	0.252
LH L 13□332J	RoHS	3300	±5%	40	0.60	3.4	0.33	0.252
LH L 13□472J	RoHS	4700	±5%	40	0.43	4.7	0.28	0.252
LH L 13□682J	RoHS	6800	±5%	30	0.38	5.6	0.25	0.252
LH L 13□103J	RoHS	10000	±5%	70	0.30	10	0.19	L: 1kHz, Q: 0.0796MHz

□ Please specify the packaging code. (TB: Taping, NB: Bulk)

▶ This catalog contains the typical specification only due to the limitation of space. When you consider the purchase of our products, please check our specification. For details of each product (characteristics graph, reliability information, precautions for use, and so on), see our Web site (<http://www.ty-top.com/>).

● LHL16

Parts number	EHS	Nominal inductance [μH]	Inductance tolerance	Q (min.)	Self-resonant frequency [MHz] (min.)	DC Resistance [Ω] (max.)	Rated current [A] (max.)	Measuring frequency [MHz]
LH L 16□470K	RoHS	47	±10%	70	4.5	0.046	3.7	2.52
LH L 16□680K	RoHS	68	±10%	70	3.9	0.054	3.3	2.52
LH L 16□101K	RoHS	100	±10%	60	2.7	0.077	2.9	0.796
LH L 16□151K	RoHS	150	±10%	60	2.3	0.11	2.4	0.796
LH L 16□221K	RoHS	220	±10%	60	1.9	0.15	2.0	0.796
LH L 16□331K	RoHS	330	±10%	40	1.6	0.21	1.5	0.796
LH L 16□471K	RoHS	470	±10%	30	1.4	0.28	1.3	0.796
LH L 16□681K	RoHS	680	±10%	20	1.2	0.35	1.1	0.796
LH L 16□102J	RoHS	1000	±5%	20	0.84	0.74	0.86	0.252
LH L 16□152J	RoHS	1500	±5%	20	0.69	0.93	0.75	0.252
LH L 16□222J	RoHS	2200	±5%	20	0.56	1.4	0.60	0.252
LH L 16□332J	RoHS	3300	±5%	20	0.49	2.2	0.50	0.252
LH L 16□472J	RoHS	4700	±5%	20	0.41	2.6	0.40	0.252
LH L 16□682J	RoHS	6800	±5%	20	0.35	3.9	0.33	0.252
LH L 16□103J	RoHS	10000	±5%	70	0.26	7.3	0.25	L: 1kHz, Q: 0.0796MHz

● LHLP10

Parts number	EHS	Nominal inductance [μH]	Inductance tolerance	DC Resistance [Ω] (max.)	Rated current [A] (max.)	Inductance Measuring frequency [MHz]
LH LP10□100M	RoHS	10	±20%	0.038	2.5	2.52
LH LP10□150M	RoHS	15	±20%	0.049	2.2	2.52
LH LP10□220M	RoHS	22	±20%	0.075	1.9	2.52
LH LP10□330M	RoHS	33	±20%	0.094	1.7	2.52
LH LP10□470M	RoHS	47	±20%	0.15	1.3	2.52
LH LP10□680M	RoHS	68	±20%	0.23	1.0	2.52
LH LP10□101K	RoHS	100	±10%	0.30	0.90	0.796
LH LP10□151K	RoHS	150	±10%	0.47	0.78	0.796
LH LP10□221K	RoHS	220	±10%	0.70	0.63	0.796
LH LP10□331K	RoHS	330	±10%	0.88	0.58	0.796
LH LP10□471K	RoHS	470	±10%	1.3	0.46	0.796
LH LP10□681K	RoHS	680	±10%	1.9	0.38	0.796
LH LP10□102K	RoHS	1000	±10%	3.2	0.30	0.252

● LHLP12NB

Parts number	EHS	Nominal inductance [μH]	Inductance tolerance	DC Resistance [Ω] (max.)	Rated current [A] (max.)	Inductance Measuring frequency [MHz]
LH LP12NB150M	RoHS	15	±20%	0.035	3.3	2.52
LH LP12NB220M	RoHS	22	±20%	0.050	2.7	2.52
LH LP12NB330M	RoHS	33	±20%	0.070	2.4	2.52
LH LP12NB470M	RoHS	47	±20%	0.081	2.1	2.52
LH LP12NB680M	RoHS	68	±20%	0.12	1.7	2.52
LH LP12NB101K	RoHS	100	±10%	0.16	1.6	0.796
LH LP12NB151K	RoHS	150	±10%	0.24	1.3	0.796
LH LP12NB221K	RoHS	220	±10%	0.38	0.95	0.796
LH LP12NB331K	RoHS	330	±10%	0.46	0.89	0.796
LH LP12NB471K	RoHS	470	±10%	0.69	0.74	0.796
LH LP12NB681K	RoHS	680	±10%	1.1	0.58	0.796
LH LP12NB102K	RoHS	1000	±10%	1.8	0.46	0.252

● LHLP16NB

Parts number	EHS	Nominal inductance [μH]	Inductance tolerance	DC Resistance [Ω] (max.)	Rated current [A] (max.)	Inductance Measuring frequency [MHz]
LH LP16NB100M	RoHS	10	±20%	0.019	5.2	1
LH LP16NB150M	RoHS	15	±20%	0.025	5.1	1
LH LP16NB220M	RoHS	22	±20%	0.027	4.6	1
LH LP16NB330M	RoHS	33	±20%	0.035	4.0	1
LH LP16NB470K	RoHS	47	±10%	0.045	3.4	1
LH LP16NB680K	RoHS	68	±10%	0.062	3.1	1
LH LP16NB101K	RoHS	100	±10%	0.091	2.3	1
LH LP16NB151K	RoHS	150	±10%	0.14	1.9	1
LH LP16NB221K	RoHS	220	±10%	0.20	1.5	1
LH LP16NB331K	RoHS	330	±10%	0.31	1.3	1
LH LP16NB471K	RoHS	470	±10%	0.47	1.0	1
LH LP16NB681K	RoHS	680	±10%	0.58	0.98	1
LH LP16NB102K	RoHS	1000	±10%	0.94	0.74	1

□ Please specify the packaging code. (TB: Taping, NB: Bulk)

● LHLCO8

Parts number	EHS	Nominal inductance [μ H]	Inductance tolerance	Q (min.)	Self-resonant frequency [MHz] (min.)	DC Resistance [Ω] (max.)	Rated current [A] (max.)	Measuring frequency [MHz]
LH LC08□1R0N	RoHS	1.0	±30%	40	76	0.013	5.4	7.96
LH LC08□1R5M	RoHS	1.5	±20%	40	65	0.014	5.2	7.96
LH LC08□2R2M	RoHS	2.2	±20%	40	56	0.017	4.8	7.96
LH LC08□2R7M	RoHS	2.7	±20%	40	48	0.019	4.2	7.96
LH LC08□3R3M	RoHS	3.3	±20%	40	41	0.021	3.8	7.96
LH LC08□3R9M	RoHS	3.9	±20%	40	33	0.024	3.7	7.96
LH LC08□4R7M	RoHS	4.7	±20%	40	30	0.025	3.6	7.96
LH LC08□5R6M	RoHS	5.6	±20%	40	23	0.028	3.5	7.96
LH LC08□6R8M	RoHS	6.8	±20%	40	21	0.030	3.4	7.96
LH LC08□8R2M	RoHS	8.2	±20%	40	19	0.034	3.0	7.96
LH LC08□100K	RoHS	10	±10%	65	17	0.041	2.9	2.52
LH LC08□120K	RoHS	12	±10%	65	16	0.044	2.8	2.52
LH LC08□150K	RoHS	15	±10%	50	13	0.053	2.6	2.52
LH LC08□180K	RoHS	18	±10%	50	12	0.060	2.4	2.52
LH LC08□220K	RoHS	22	±10%	50	11	0.068	2.3	2.52
LH LC08□270K	RoHS	27	±10%	50	10	0.091	2.0	2.52
LH LC08□330K	RoHS	33	±10%	40	8.8	0.10	1.9	2.52
LH LC08□390K	RoHS	39	±10%	40	8.4	0.12	1.7	2.52
LH LC08□470K	RoHS	47	±10%	40	8.2	0.15	1.5	2.52
LH LC08□560K	RoHS	56	±10%	40	7.9	0.17	1.4	2.52
LH LC08□680K	RoHS	68	±10%	35	7.0	0.20	1.3	2.52
LH LC08□820K	RoHS	82	±10%	35	6.5	0.22	1.2	2.52
LH LC08□101K	RoHS	100	±10%	25	5.7	0.32	1.0	0.796
LH LC08□121K	RoHS	120	±10%	25	5.2	0.36	0.96	0.796
LH LC08□151K	RoHS	150	±10%	20	4.7	0.41	0.88	0.796
LH LC08□181K	RoHS	180	±10%	35	4.2	0.66	0.71	0.796
LH LC08□221K	RoHS	220	±10%	35	3.7	0.73	0.66	0.796
LH LC08□271K	RoHS	270	±10%	25	3.5	0.85	0.63	0.796
LH LC08□331K	RoHS	330	±10%	25	3.2	0.97	0.59	0.796
LH LC08□391K	RoHS	390	±10%	20	2.9	1.1	0.55	0.796
LH LC08□471K	RoHS	470	±10%	25	2.4	1.3	0.49	0.796
LH LC08□561K	RoHS	560	±10%	25	2.2	1.5	0.47	0.796
LH LC08□681K	RoHS	680	±10%	25	2.0	1.8	0.44	0.796
LH LC08□821K	RoHS	820	±10%	30	1.6	2.3	0.38	0.796
LH LC08□102J	RoHS	1000	±5%	55	1.5	2.7	0.35	0.252
LH LC08□122J	RoHS	1200	±5%	45	1.4	3.2	0.31	0.252
LH LC08□152J	RoHS	1500	±5%	55	1.3	4.1	0.29	0.252
LH LC08□182J	RoHS	1800	±5%	55	1.2	4.8	0.26	0.252
LH LC08□222J	RoHS	2200	±5%	55	1.1	5.6	0.23	0.252
LH LC08□272J	RoHS	2700	±5%	55	1.0	7.5	0.21	0.252
LH LC08□332J	RoHS	3300	±5%	55	0.85	8.5	0.19	0.252
LH LC08□392J	RoHS	3900	±5%	55	0.78	9.7	0.18	0.252
LH LC08□472J	RoHS	4700	±5%	65	0.68	14	0.16	0.252
LH LC08□562J	RoHS	5600	±5%	65	0.62	16	0.15	0.252
LH LC08□682J	RoHS	6800	±5%	65	0.61	18	0.14	0.252
LH LC08□822J	RoHS	8200	±5%	65	0.60	20	0.13	0.252
LH LC08□103J	RoHS	10000	±5%	60	0.48	32	0.11	L: 1kHz, Q: 0.0796MHz
LH LC08□123J	RoHS	12000	±5%	60	0.44	36	0.084	L: 1kHz, Q: 0.0796MHz
LH LC08□153J	RoHS	15000	±5%	60	0.35	62	0.068	L: 1kHz, Q: 0.0796MHz
LH LC08□183J	RoHS	18000	±5%	60	0.30	72	0.066	L: 1kHz, Q: 0.0796MHz
LH LC08□223J	RoHS	22000	±5%	60	0.28	82	0.057	L: 1kHz, Q: 0.0796MHz
LH LC08□273J	RoHS	27000	±5%	60	0.25	90	0.054	L: 1kHz, Q: 0.0796MHz
LH LC08□333J	RoHS	33000	±5%	60	0.23	100	0.053	L: 1kHz, Q: 0.0796MHz

□ Please specify the packaging code. (TB: Taping, NB: Bulk)

LHLC10

Parts number	EHS	Nominal inductance [μ H]	Inductance tolerance	Q (min.)	Self-resonant frequency [MHz] (min..)	DC Resistance [Ω] (max.)	Rated current [A] (max.)	Measuring frequency [MHz]
LH LC10□3R3M	RoHS	3.3	±20%	50	46	0.019	5.0	7.96
LH LC10□3R9M	RoHS	3.9	±20%	50	40	0.022	4.8	7.96
LH LC10□4R7M	RoHS	4.7	±20%	50	38	0.024	4.7	7.96
LH LC10□5R6M	RoHS	5.6	±20%	50	34	0.025	4.5	7.96
LH LC10□6R8M	RoHS	6.8	±20%	50	30	0.028	4.1	7.96
LH LC10□8R2M	RoHS	8.2	±20%	50	24	0.031	3.9	7.96
LH LC10□100K	RoHS	10	±10%	90	19	0.034	3.6	2.52
LH LC10□120K	RoHS	12	±10%	90	16	0.038	3.4	2.52
LH LC10□150K	RoHS	15	±10%	90	12	0.042	3.2	2.52
LH LC10□180K	RoHS	18	±10%	90	9.2	0.046	3.0	2.52
LH LC10□220K	RoHS	22	±10%	60	8.6	0.061	2.8	2.52
LH LC10□270K	RoHS	27	±10%	60	7.1	0.069	2.7	2.52
LH LC10□330K	RoHS	33	±10%	60	6.8	0.078	2.6	2.52
LH LC10□390K	RoHS	39	±10%	60	6.7	0.085	2.4	2.52
LH LC10□470K	RoHS	47	±10%	50	6.2	0.093	2.3	2.52
LH LC10□560K	RoHS	56	±10%	50	5.2	0.10	2.1	2.52
LH LC10□680K	RoHS	68	±10%	40	4.6	0.12	2.0	2.52
LH LC10□820K	RoHS	82	±10%	40	4.7	0.13	1.8	2.52
LH LC10□101K	RoHS	100	±10%	40	3.8	0.18	1.5	0.796
LH LC10□121K	RoHS	120	±10%	40	3.2	0.25	1.3	0.796
LH LC10□151K	RoHS	150	±10%	40	2.9	0.29	1.2	0.796
LH LC10□181K	RoHS	180	±10%	40	2.6	0.40	1.0	0.796
LH LC10□221K	RoHS	220	±10%	40	2.3	0.44	0.97	0.796
LH LC10□271K	RoHS	270	±10%	30	2.1	0.50	0.90	0.796
LH LC10□331K	RoHS	330	±10%	30	2.0	0.56	0.86	0.796
LH LC10□391K	RoHS	390	±10%	30	1.8	0.62	0.75	0.796
LH LC10□471K	RoHS	470	±10%	30	1.7	0.84	0.65	0.796
LH LC10□561K	RoHS	560	±10%	30	1.5	0.93	0.61	0.796
LH LC10□681K	RoHS	680	±10%	30	1.4	1.0	0.57	0.796
LH LC10□821K	RoHS	820	±10%	30	1.3	1.4	0.50	0.796
LH LC10□102J	RoHS	1000	±5%	50	1.2	1.8	0.48	0.252
LH LC10□122J	RoHS	1200	±5%	50	0.87	2.3	0.40	0.252
LH LC10□152J	RoHS	1500	±5%	50	0.83	2.7	0.37	0.252
LH LC10□182J	RoHS	1800	±5%	50	0.75	3.0	0.36	0.252
LH LC10□222J	RoHS	2200	±5%	50	0.70	3.9	0.32	0.252
LH LC10□272J	RoHS	2700	±5%	50	0.67	4.3	0.30	0.252
LH LC10□332J	RoHS	3300	±5%	50	0.56	5.8	0.26	0.252
LH LC10□392J	RoHS	3900	±5%	50	0.54	6.4	0.25	0.252
LH LC10□472J	RoHS	4700	±5%	50	0.49	7.1	0.24	0.252
LH LC10□562J	RoHS	5600	±5%	50	0.41	9.0	0.21	0.252
LH LC10□682J	RoHS	6800	±5%	50	0.38	10	0.20	0.252
LH LC10□822J	RoHS	8200	±5%	50	0.36	12	0.18	0.252
LH LC10□103J	RoHS	10000	±5%	60	0.29	19	0.14	L: 1kHz, Q: 0.0796MHz
LH LC10□123J	RoHS	12000	±5%	60	0.27	21	0.13	L: 1kHz, Q: 0.0796MHz
LH LC10□153J	RoHS	15000	±5%	60	0.24	34	0.11	L: 1kHz, Q: 0.0796MHz
LH LC10□183J	RoHS	18000	±5%	60	0.21	38	0.10	L: 1kHz, Q: 0.0796MHz
LH LC10□223J	RoHS	22000	±5%	60	0.20	43	0.095	L: 1kHz, Q: 0.0796MHz
LH LC10□273J	RoHS	27000	±5%	40	0.15	67	0.076	L: 1kHz, Q: 0.0796MHz
LH LC10□333J	RoHS	33000	±5%	40	0.14	76	0.068	L: 1kHz, Q: 0.0796MHz
LH LC10□393J	RoHS	39000	±5%	40	0.13	84	0.065	L: 1kHz, Q: 0.0796MHz
LH LC10□473J	RoHS	47000	±5%	40	0.12	96	0.061	L: 1kHz, Q: 0.0796MHz
LH LC10□563J	RoHS	56000	±5%	30	0.10	170	0.045	L: 1kHz, Q: 0.0796MHz
LH LC10□683J	RoHS	68000	±5%	30	0.095	200	0.043	L: 1kHz, Q: 0.0796MHz
LH LC10□823J	RoHS	82000	±5%	30	0.088	210	0.041	L: 1kHz, Q: 0.0796MHz
LH LC10□104J	RoHS	100000	±5%	30	0.085	240	0.038	L: 1kHz, Q: 0.0252MHz
LH LC10□124J	RoHS	120000	±5%	30	0.070	260	0.037	L: 1kHz, Q: 0.0252MHz
LH LC10□154J	RoHS	150000	±5%	30	0.069	300	0.035	L: 1kHz, Q: 0.0252MHz

□ Please specify the packaging code. (TB: Taping, NB: Bulk)

RADIAL LEADED INDUCTORS

PACKAGING

① Minimum Quantity

Type (EIA)	Standard quantity [pcs]		
	Box	Bulk	Taped
LHL 08	—	100	1000
LHL 10	—	50	500
LHL 13	—	25	500
LHL 16	500	—	250
LHLP10	500	—	200
LHLP12NB	300	—	—
LHLP16NB	200	—	—
LHLC08	—	100	1000
LHLC10	—	50	500

② Bulk dimensions

LHL08~16

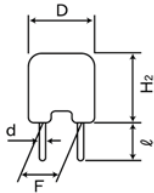

Type	Dimensions				
	ϕD (max)	H_2 (max)	F^*	l	ϕd
LHL08	9.0 (0.354)	9.5 (0.374)	5.0 ± 1.0 (0.197±0.039)	5.0 ± 1.0 (0.197±0.039)	0.6 ± 0.05 (0.024±0.002)
LHL10	11.0 (0.433)	14.0 (0.551)	5.0 ± 1.0 (0.197±0.039)	5.0 ± 1.0 (0.197±0.039)	0.6 ± 0.05 (0.024±0.002)
LHL13	14.0 (0.551)	17.0 (0.669)	7.5 ± 1.0 (0.295±0.039)	5.0 ± 1.0 (0.197±0.039)	0.8 ± 0.05 (0.031±0.002)
LHL16	17.0 (0.669)	21.0 (0.827)	7.5 ± 1.0 (0.295±0.039)	5.0 ± 1.0 (0.197±0.039)	0.8 ± 0.05 (0.031±0.002)

Unit: mm (inch)

*Measured at the base of the leads.

LHLP10~16

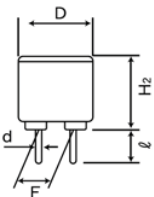

Type	Dimensions				
	ϕD (max)	H_2 (max)	F^*	l	ϕd
LHLP10	11.0 (0.433)	11.0 (0.433)	5.0 ± 1.0 (0.197±0.039)	5.0 ± 1.0 (0.197±0.039)	0.6 ± 0.05 (0.024±0.004)
LHLP12	13.0 (0.512)	16.0 (0.624)	5.0 ± 1.0 (0.197±0.039)	5.0 ± 1.0 (0.197±0.039)	0.6 ± 0.05 (0.024±0.004)
LHLP16	17.0 (0.669)	19.0 (0.741)	7.5 ± 1.0 (0.295±0.039)	5.0 ± 1.0 (0.197±0.039)	0.8 ± 0.05 (0.031±0.004)

Unit: mm (inch)

*Measured at the base of the leads.

● LHL08~16

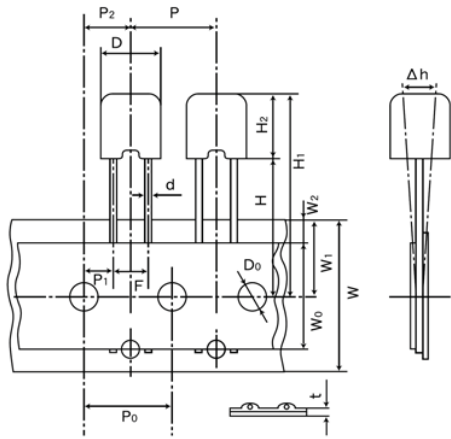

	LHL08	LHL10	LHL13	LHL16
D	$\phi 9.0 \text{ max}$ ($\phi 0.354 \text{ max}$)	$\phi 11.0 \text{ max}$ ($\phi 0.433 \text{ max}$)	$\phi 14.0 \text{ max}$ ($\phi 0.551 \text{ max}$)	$\phi 17.0 \text{ max}$ ($\phi 0.669 \text{ max}$)
H ₁	30.5 max (1.20 max)	34.0 max (1.34 max)	37.0 max (1.46 max)	41.0 max (1.61 max)
H	18.0+2.0/-0.0 (0.709+0.079/-0.000)	18.0+2.0/-0.0 (0.709+0.079/-0.000)	18.0+2.0/-0.0 (0.709+0.079/-0.000)	18.0+2.0/-0.0 (0.709+0.079/-0.000)
H ₂	9.5 max (0.374 max)	14.0 max (0.551 max)	17.0 max (0.669 max)	21.0 max (0.827 max)
P	12.7±1.0 (0.500±0.039)	12.7±1.0 (0.500±0.039)	15.0±1.0 (0.591±0.039)	30.0±1.0 (1.18±0.039)
P ₀	12.7±0.3 ^{※1} (0.500±0.012)	12.7±0.3 ^{※1} (0.500±0.012)	15.0±0.3 ^{※1} (0.591±0.012)	15.0±0.3 ^{※1} (0.591±0.012)
P ₁	3.85±0.7 (0.152±0.028)	3.85±0.7 (0.152±0.028)	3.75±0.7 (0.148±0.028)	3.75±0.7 (0.148±0.028)
P ₂	6.35±1.3 (0.250±0.051)	6.35±1.3 (0.250±0.051)	7.50±1.3 (0.295±0.051)	7.50±1.3 (0.295±0.051)
F	5.0+0.8/-0.2 (0.197+0.031/-0.008)	5.0+0.8/-0.2 (0.197+0.031/-0.008)	7.50+0.8/-0.2 (0.295+0.031/-0.008)	7.50±0.5 (0.295±0.020)
h	0.0±2.0 (0.0±0.079)	0.0±2.0 (0.0±0.079)	0.0±2.0 (0.0±0.079)	0.0±2.0 (0.0±0.079)
W	18.0+1.0/-0.5 (0.709+0.039/-0.020)	18.0+1.0/-0.5 (0.709+0.039/-0.020)	18.0+1.0/-0.5 (0.709+0.039/-0.020)	18.0+1.0/-0.5 (0.709+0.039/-0.020)
W ₀	12.5 min (0.492 min)	12.5 min (0.492 min)	12.5 min (0.492 min)	12.5 min (0.492 min)
W ₁	9.0±0.5 (0.354±0.020)	9.0±0.5 (0.354±0.020)	9.0±0.5 (0.354±0.020)	9.0±0.5 (0.354±0.020)
W ₂	3.0 max ^{※2} (0.118 max)	3.0 max ^{※2} (0.118 max)	3.0 max ^{※2} (0.118 max)	3.0 max ^{※2} (0.118 max)
D ₀	$\phi 4.0 \pm 0.2$ ($\phi 0.158 \pm 0.008$)	$\phi 4.0 \pm 0.2$ ($\phi 0.158 \pm 0.008$)	$\phi 4.0 \pm 0.2$ ($\phi 0.158 \pm 0.008$)	$\phi 4.0 \pm 0.2$ ($\phi 0.158 \pm 0.008$)
ϕd	$\phi 0.6 \pm 0.05$ ($\phi 0.024 \pm 0.002$)	$\phi 0.6 \pm 0.05$ ($\phi 0.024 \pm 0.002$)	$\phi 0.8 \pm 0.05$ ($\phi 0.031 \pm 0.002$)	$\phi 0.8 \pm 0.05$ ($\phi 0.031 \pm 0.002$)
t	0.6±0.3 (0.024±0.012)	0.6±0.3 (0.024±0.012)	0.6±0.3 (0.024±0.012)	0.6±0.3 (0.024±0.012)

Unit: mm (inch)

※1 Accumulated error for 20 pitches is 1mm.

※2 Bonding tape must not protrude from the base tape.

● LHLP10TB

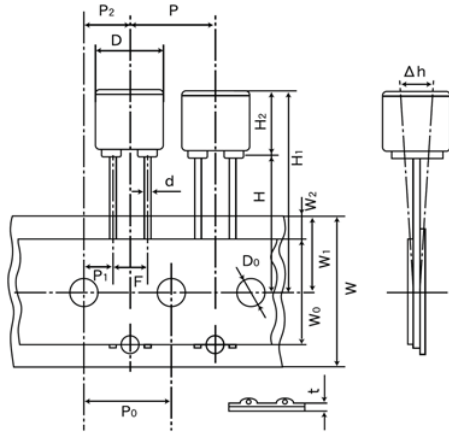

Type	Symbol	Dimensions	Symbol	Dimensions
LHLP10	D	$\phi 11.0 \text{ max}$ ($\phi 0.433 \text{ max}$)	h	0.0 ± 2.0 (0.0 ± 0.079)
	H ₁	32.0 max (1.26 max)	W	$18.0 + 1.0 / - 0.5$ ($0.709 + 0.039 / - 0.020$)
	H	$18.0 + 2.0 / - 0.0$ ($0.709 + 0.079 / - 0.000$)	W ₀	12.5 min (0.492 min)
	H ₂	11.0 max (0.433 max)	W ₁	9.0 ± 0.5 (0.354 ± 0.020)
	P	12.7 ± 1.0 (0.500 ± 0.039)	W ₂	$3.0 \text{ max}^{※2}$ (0.118 max)
	P ₀	$12.7 \pm 0.3^{※1}$ (0.500 ± 0.012)	D ₀	$\phi 4.0 \pm 0.2$ ($\phi 0.158 \pm 0.008$)
	P ₁	3.85 ± 0.7 (0.152 ± 0.028)	ϕd	$\phi 0.6 \pm 0.05$ ($\phi 0.024 \pm 0.002$)
	P ₂	6.35 ± 1.3 (0.250 ± 0.051)	t	0.6 ± 0.3 (0.024 ± 0.012)
	F	$5.0 + 0.8 / - 0.2$ ($0.197 + 0.031 / - 0.008$)		

Unit: mm (inch)

※1 Accumulated error for 20 pitches is 1mm.

※2 Bonding tape must not protrude from the base tape.

● LHLC08, LHLC10

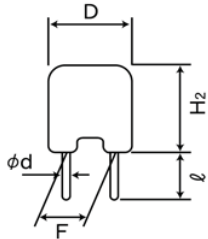

Type	Dimensions				
	$\phi D (\text{max})$	H ₂ (max)	F*	l	ϕd
LHLC08	9.0 (0.354)	9.5 (0.374)	5.0 ± 1.0 (0.197 ± 0.039)	5.0 ± 1.0 (0.197 ± 0.039)	0.6 ± 0.05 (0.024 ± 0.002)
LHLC10	11.0 (0.433)	14.0 (0.551)	5.0 ± 1.0 (0.197 ± 0.039)	5.0 ± 1.0 (0.197 ± 0.039)	0.6 ± 0.05 (0.024 ± 0.002)

Unit: mm (inch)

*Measured at the base of the leads.

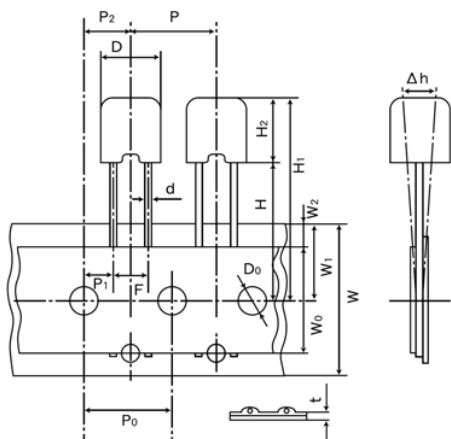

	LHLC08	LHLC10
D	$\phi 9.0\text{max}$ ($\phi 0.354\text{max}$)	$\phi 11.0\text{max}$ ($\phi 0.433\text{max}$)
H ₁	30.5max (1.20max)	34.0max (1.34max)
H	18.0+2.0/-0.0 (0.709+0.079/-0.000)	18.0+2.0/-0.0 (0.709+0.079/-0.000)
H ₂	9.5max (0.374max)	14.0max (0.551max)
P	12.7±1.0 (0.500±0.039)	12.7±1.0 (0.500±0.039)
P ₀	12.7±0.3 ^{※1} (0.500±0.012)	12.7±0.3 ^{※1} (0.500±0.012)
P ₁	3.85±0.7 (0.152±0.028)	3.85±0.7 (0.152±0.028)
P ₂	6.35±1.3 (0.250±0.051)	6.35±1.3 (0.250±0.051)
F	5.0+0.8/-0.2 (0.197+0.031/-0.008)	5.0+0.8/-0.2 (0.197+0.031/-0.008)
H	0.0±2.0 (0.0±0.079)	0.0±2.0 (0.0±0.079)
W	18.0+1.0/-0.5 (0.709+0.039/-0.020)	18.0+1.0/-0.5 (0.709+0.039/-0.020)
W ₀	12.5min (0.492min)	12.5min (0.492min)
W ₁	9.0±0.5 (0.354±0.020)	9.0±0.5 (0.354±0.020)
W ₂	3.0max ^{※2} (0.118max)	3.0max ^{※2} (0.118max)
D ₀	$\phi 4.0\pm 0.2$ ($\phi 0.158\pm 0.008$)	$\phi 4.0\pm 0.2$ ($\phi 0.158\pm 0.008$)
ϕd	$\phi 0.6\pm 0.05$ ($\phi 0.024\pm 0.002$)	$\phi 0.6\pm 0.05$ ($\phi 0.024\pm 0.002$)
t	0.6±0.3 (0.024±0.012)	0.6±0.3 (0.024±0.012)

Unit : mm (inch)

※1 Accumulated error for 20 pitches is 1mm.

※2 Bonding tape must not protrude from the base tape.

6. Q		
Specified Value	CAL45 Type	
	LHL□□□	Within the specified tolerance
	FBA/FBR	
Test Methods and Remarks	LHL□□□ (except LHLP) : Measuring equipment : LCR meter (HP4285A+HP42851A or its equivalent) : LCR meter (HP4263A) or its equivalent (at 1kHz) Measuring frequency : Specified frequency	

7. DC Resistance		
Specified Value	CAL45 Type	
	LHL□□□	Within the specified tolerance
	FBA/FBR	
Test Methods and Remarks	Measuring equipment : DC ohmmeter	

8. Self resonance frequency		
Specified Value	CAL45 Type	
	LHL□□□	Within the specified tolerance
	FBA/FBR	
Test Methods and Remarks	LHL□□□(except LHLP) : Measuring equipment : (HP4191A, 4192A) its equivalent	

9. Temperature characteristic																
Specified Value	CAL45 Type															
	LHL□□□	$\Delta L/L$: Within $\pm 7\%$ (except LHLP16 : Within $\pm 20\%$)														
	FBA/FBR															
Test Methods and Remarks	Change of maximum inductance deviation in step 1 to 5 <table border="1" style="margin-left: 20px;"> <thead> <tr> <th>Step</th> <th>Temperature (°C)</th> </tr> </thead> <tbody> <tr> <td></td> <td>LHL□□□</td> </tr> <tr> <td>1</td> <td>20</td> </tr> <tr> <td>2</td> <td>Minimum operating temperature</td> </tr> <tr> <td>3</td> <td>20 (Standard temperature)</td> </tr> <tr> <td>4</td> <td>Maximum operating temperature</td> </tr> <tr> <td>5</td> <td>20</td> </tr> </tbody> </table>		Step	Temperature (°C)		LHL□□□	1	20	2	Minimum operating temperature	3	20 (Standard temperature)	4	Maximum operating temperature	5	20
Step	Temperature (°C)															
	LHL□□□															
1	20															
2	Minimum operating temperature															
3	20 (Standard temperature)															
4	Maximum operating temperature															
5	20															

10. Tensile strength test																
Specified Value	CAL45 Type															
	LHL□□□	No abnormality such as cut lead, or looseness.														
	FBA/FBR															
Test Methods and Remarks	CAL45 Type : Apply the stated tensile force progressively in the direction to draw terminal. <table border="1" style="margin-left: 20px;"> <thead> <tr> <th>force (N)</th> <th>duration (s)</th> </tr> </thead> <tbody> <tr> <td>10</td> <td>10</td> </tr> </tbody> </table> LHL□□□ : Apply the stated tensile force progressively in the direction to draw terminal. <table border="1" style="margin-left: 20px;"> <thead> <tr> <th>Nominal wire diameter tensile ϕd (mm)</th> <th>force (N)</th> <th>duration (s)</th> </tr> </thead> <tbody> <tr> <td>$0.3 < \phi d \leq 0.5$</td> <td>5</td> <td rowspan="3">30 \pm 5</td> </tr> <tr> <td>$0.5 < \phi d \leq 0.8$</td> <td>10</td> </tr> <tr> <td>$0.8 < \phi d \leq 1.2$</td> <td>25</td> </tr> </tbody> </table> FBA/FBR : The body of a component shall be fixed and a tensile force of 20 \pm 1N shall be applied to the lead wire in the axial direction of the component during 10 \pm 1 seconds.		force (N)	duration (s)	10	10	Nominal wire diameter tensile ϕd (mm)	force (N)	duration (s)	$0.3 < \phi d \leq 0.5$	5	30 \pm 5	$0.5 < \phi d \leq 0.8$	10	$0.8 < \phi d \leq 1.2$	25
force (N)	duration (s)															
10	10															
Nominal wire diameter tensile ϕd (mm)	force (N)	duration (s)														
$0.3 < \phi d \leq 0.5$	5	30 \pm 5														
$0.5 < \phi d \leq 0.8$	10															
$0.8 < \phi d \leq 1.2$	25															

▶ This catalog contains the typical specification only due to the limitation of space. When you consider the purchase of our products, please check our specification. For details of each product (characteristics graph, reliability information, precautions for use, and so on), see our Web site (<http://www.ty-top.com/>).

11. Over current		
Specified Value	CAL45 Type	No emission of smoke no firing.
	LHL□□□	There shall be no scorch or short of wire. LHLC08, LHLC10 : There shall be no firing.
	FBA/FBR	
Test Methods and Remarks	LHL□□□・CAL45 Type : Measuring current : Rated current × 2 Duration : 5 min. Number of measuring : one time	

12. Terminal strength : bending													
Specified Value	CAL45 Type	No abnormality such as cut lead, or looseness.											
	LHL□□□												
	FBA/FBR												
Test Methods and Remarks	CAL45 Type : Suspend a weight of specified mass at the end of the terminals and incline the body through the angle of 90 degrees and return it to the initial position. This operation is done over a period of 2-3 sec. Then second bend in the opposite direction shall be made. Number of bends : Two times.												
	<table border="1"> <thead> <tr> <th>Nominal wire diameter tensile</th> <th>Bending force</th> <th>Mass reference weight</th> </tr> </thead> <tbody> <tr> <td>$0.3 < \phi d \leq 0.5$</td> <td>2.5</td> <td>0.25</td> </tr> <tr> <td>$0.5 < \phi d \leq 0.8$</td> <td>5</td> <td>0.50</td> </tr> </tbody> </table>		Nominal wire diameter tensile	Bending force	Mass reference weight	$0.3 < \phi d \leq 0.5$	2.5	0.25	$0.5 < \phi d \leq 0.8$	5	0.50		
	Nominal wire diameter tensile	Bending force	Mass reference weight										
	$0.3 < \phi d \leq 0.5$	2.5	0.25										
	$0.5 < \phi d \leq 0.8$	5	0.50										
LHL□□□・FBA/FBR : Suspend a weight of specified mass at the end of the terminals and incline the body through the angle of 90 degrees and return it to the initial position. This operation is done over a period of 2-3 sec. Then second bend in the opposite direction shall be made. Number of bends : Two times.													
<table border="1"> <thead> <tr> <th>Nominal wire diameter tensile</th> <th>Bending force</th> <th>Mass reference weight</th> </tr> </thead> <tbody> <tr> <td>$0.3 < \phi d \leq 0.5$</td> <td>2.5</td> <td>0.25</td> </tr> <tr> <td>$0.5 < \phi d \leq 0.8$</td> <td>5</td> <td>0.5</td> </tr> <tr> <td>$0.8 < \phi d \leq 1.2$</td> <td>10</td> <td>1.0</td> </tr> </tbody> </table>		Nominal wire diameter tensile	Bending force	Mass reference weight	$0.3 < \phi d \leq 0.5$	2.5	0.25	$0.5 < \phi d \leq 0.8$	5	0.5	$0.8 < \phi d \leq 1.2$	10	1.0
Nominal wire diameter tensile	Bending force	Mass reference weight											
$0.3 < \phi d \leq 0.5$	2.5	0.25											
$0.5 < \phi d \leq 0.8$	5	0.5											
$0.8 < \phi d \leq 1.2$	10	1.0											

13. Insulation resistance : between the terminals and body		
Specified Value	CAL45 Type	100MΩ min.
	LHL□□□	
	FBA/FBR	
Test Methods and Remarks	LHL□□□ : Applied voltage : 500 VDC Duration : 60 sec.	

14. Insulation resistance : between terminals and core		
Specified Value	CAL45 Type	1MΩ min.
	LHL□□□	
	FBA/FBR	
Test Methods and Remarks	FBA/FBR : Applied voltage : 100 VDC Duration : 60±5 sec.	

15. Withstanding : between the terminals and body		
Specified Value	CAL45 Type	No abnormality such as insulation damage
	LHL□□□	
	FBA/FBR	
Test Methods and Remarks	LHL□□□ : According to JIS C5102. 7. 1. 3 (C) Metal global method Applied voltage : 500 VDC Duration : 60 sec.	

▶ This catalog contains the typical specification only due to the limitation of space. When you consider the purchase of our products, please check our specification.
For details of each product (characteristics graph, reliability information, precautions for use, and so on), see our Web site (<http://www.ty-top.com/>).

16. DC bias characteristic		
Specified Value	CAL45 Type	$\Delta L/L$: Within -10%
	LHL□□□	
	FBA/FBR	
Test Methods and Remarks	CAL45 Type : Measure inductance with application of rated current using LCR meter to compare it with the initial value.	

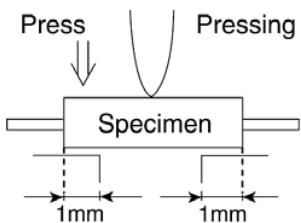
17. Body strength		
Specified Value	CAL45 Type	No abnormality as damage.
	LHL□□□	
	FBA/FBR	No abnormality such as cracks on body.
Test Methods and Remarks	<p>CAL45 Type :</p> <p>Applied force : 50N Duration : 10 sec. Speed : Shall attain to specified force in 2 sec.</p> <p>FBA :</p> <p>Applied force : $50 \pm 3N$ Duration : 30 ± 1 sec.</p> <p>Press  Pressing jig</p>	

18. Resistance to vibration		
Specified Value	CAL45 Type	$\Delta L/L$: Within $\pm 5\%$
	LHL□□□	Appearance : No abnormality $\Delta L/L$: Within $\pm 5\%$ Q change : Within $\pm 30\%$ (LHLP : only $\Delta L/L$)
	FBA/FBR	Appearance : No abnormality Impedance change : Within $\pm 20\%$
Test Methods and Remarks	<p>CAL45 Type :</p> <p>Directions : 2 hrs each in X, Y and Z directions total : 6hrs. Frequency range : 10 to 55 to 10Hz (1min.) Amplitude : 1.5mm Mounting method : Soldering onto printed board. Recovery : At least 1hr of recovery under the standard condition after the test, followed by the measurement within 2hrs.</p> <p>LHL□□□·FBA/FBR :</p> <p>Directions : 2 hrs each in X, Y and Z directions total : 6hrs. Frequency range : 10 to 55 to 10Hz (1min.) Amplitude : 1.5mm Mounting method : Soldering onto printed board.</p>	

19. Resistance to shock		
Specified Value	CAL45 Type	No significant abnormality in appearance
	LHL□□□	
	FBA/FBR	
Test Methods and Remarks	<p>CAL45 Type :</p> <p>Drop test</p> <p>Impact material : concrete or vinyl tile Height : 1m Total number of drops : 10 times</p>	

20. Solderability		
Specified Value	CAL45 Type	At least 75% of terminal electrode is covered by new solder.
	LHL□□□	At least 75% of terminal electrode is covered by new solder.
	FBA/FBR	At least 90% of terminal electrode is covered by new solder.
Test Methods and Remarks	CAL45 Type : Solder temperature : 230±5°C Duration : 2±0.5 sec. LHL□□□ : Solder temperature : 235±5°C Duration : 2±0.5 sec. Immersion depth : Up to 1.5mm from bottom of case. FBA/FBR : Solder temperature : 230±5°C Duration : 3±1 sec. Immersion depth : Up to 1.5mm from terminal root.	

21. Resistance to soldering heat		
Specified Value	CAL45 Type	ΔL/L : Within ±5%
	LHL□□□	No significant abnormality in appearance Inductance change : Within ±5% Q change : Within ±30%(LHLP : only ΔL/L)
	FBA/FBR	No significant abnormality in appearance Impedance change : Within ±20%
Test Methods and Remarks	CAL45 Type : Solder temperature : 270±5°C Duration : 5±0.5 sec. One time Immersed conditions : Inserted into substrate with t=1.6mm Recovery : At least 1hr of recovery under the standard condition after the test, followed by the measurement within 2hrs. LHL□□□ : Solder bath method : Solder temperature : 260±5°C Duration : 10±1 sec. : Up to 1.5mm from the bottom of case. Manual soldering : Solder temperature : 350±10°C (At the tip of soldering iron) Duration : 5±1 sec. : Up to 1.5mm from the bottom of case. Caution : No excessive pressing shall be applied to terminals. Recovery : 4 to 24hrs of recovery under the standard condition after the test. FBA/FBR : Solder bath method: Condition 1 : Solder temperature : 260±5°C Duration : 10±1 sec. Immersion depth : Up to 1.5mm from the terminal root. Condition 2 : Solder temperature : 350±5°C Duration : 3±1 sec. Immersion depth : Up to 1.5mm from the terminal root. Recovery : 3hrs of recovery under the standard condition after the test.	

22. Resistance to solvent		
Specified Value	CAL45 Type	Please avoid the ultrasonic cleaning of this product.
	LHL□□□	
	FBA/FBR	No significant abnormality in appearance Impedance change : Within ±20%
Test Methods and Remarks	FBA/FBR : Solvent temperature : 20~25°C Duration : 30±5 sec. Solvent type : Acetone Recovery : 3hrs of recovery under the standard condition after the test.	

▶ This catalog contains the typical specification only due to the limitation of space. When you consider the purchase of our products, please check our specification. For details of each product (characteristics graph, reliability information, precautions for use, and so on), see our Web site (<http://www.ty-top.com/>).

23. Thermal shock																	
Specified Value	CAL45 Type	$\Delta L/L$: Within $\pm 10\%$															
	LHL□□□	Appearance : No abnormality Inductance change : Within $\pm 10\%$ Q change : Within $\pm 30\%$ (LHLP: only $\Delta L/L$)															
	FBA/FBR	Appearance : No abnormality Impedance change : Within $\pm 20\%$															
Test Methods and Remarks	CAL45 Type: Conditions for 1 cycle																
	<table border="1"> <thead> <tr> <th>Step</th> <th>Temperature (°C)</th> <th>Duration (min.)</th> </tr> </thead> <tbody> <tr> <td>1</td> <td>-25+0/-3</td> <td>30±3</td> </tr> <tr> <td>2</td> <td>Room temperature</td> <td>Within 3</td> </tr> <tr> <td>3</td> <td>+85+2/-0</td> <td>30±3</td> </tr> <tr> <td>4</td> <td>Room temperature</td> <td>Within 3</td> </tr> </tbody> </table>	Step	Temperature (°C)	Duration (min.)	1	-25+0/-3	30±3	2	Room temperature	Within 3	3	+85+2/-0	30±3	4	Room temperature	Within 3	
	Step	Temperature (°C)	Duration (min.)														
	1	-25+0/-3	30±3														
	2	Room temperature	Within 3														
3	+85+2/-0	30±3															
4	Room temperature	Within 3															
Number of cycles : 5 cycles																	
Recovery : At least 1hr of recovery under the standard condition after the removal from test chamber, followed by the measurement within 2hrs.																	
LHL□□□•FBA/FBR: According to JIS C0025																	
Test Methods and Remarks	Conditions for 1 cycle																
	<table border="1"> <thead> <tr> <th>Step</th> <th>Temperature (°C)</th> <th>Duration (min.)</th> </tr> </thead> <tbody> <tr> <td>1</td> <td>Minimum operating temperature +0/-3</td> <td>30±3</td> </tr> <tr> <td>2</td> <td>Room temperature</td> <td>Within 3</td> </tr> <tr> <td>3</td> <td>Minimum operating temperature +2/-0</td> <td>30±3</td> </tr> <tr> <td>4</td> <td>Room temperature</td> <td>Within 3</td> </tr> </tbody> </table>	Step	Temperature (°C)	Duration (min.)	1	Minimum operating temperature +0/-3	30±3	2	Room temperature	Within 3	3	Minimum operating temperature +2/-0	30±3	4	Room temperature	Within 3	
	Step	Temperature (°C)	Duration (min.)														
	1	Minimum operating temperature +0/-3	30±3														
	2	Room temperature	Within 3														
3	Minimum operating temperature +2/-0	30±3															
4	Room temperature	Within 3															
Number of cycles : 10 cycles [LHL□□□]																	
Recovery : 5 cycles (FBA/ FBR)																	
: 4 to 24hrs of recovery under the standard condition after the removal from the test chamber. [LHL□□□]																	
: 3hrs of recovery under the standard condition after the removal from the test chamber. (FBA/ FBR)																	

24. Damp heat		
Specified Value	CAL45 Type	$\Delta L/L$: Within $\pm 10\%$
	LHL□□□	
	FBA/FBR	Appearance : No abnormality Impedance change : Within $\pm 20\%$
Test Methods and Remarks	CAL45 Type :	
	Temperature	: 40±2°C
	Humidity	: 90~95%RH
	Duration	: 1000 hrs
	Recovery	: At least 1hr of recovery under the standard removal from test chamber, followed by the measurement within 2hrs.
Test Methods and Remarks	FBA/FBR :	
	Temperature	: 60±2°C
	Humidity	: 90~95%RH
	Duration	: 1000 hrs
	Recovery	: 1 to 2hrs of recovery under the standard condition after the removal from the test chamber.

25. Loading under damp heat		
Specified Value	CAL45 Type	$\Delta L/L$: Within $\pm 10\%$
	LHL□□□	Appearance : No abnormality Inductance change : Within $\pm 10\%$ Q change : Within $\pm 30\%$ (LHLP : only $\Delta L/L$)
	FBA/FBR	
Test Methods and Remarks	CAL45 Type : Temperature : $40 \pm 2^\circ\text{C}$ Humidity : $90 \sim 95\% \text{RH}$ Duration : 1000 hrs Applied current : Rated current Recovery : At least 1hr of recovery under the standard removal from test chamber, followed by the measurement within 2hrs. LHL□□□ : Temperature : $40 \pm 2^\circ\text{C}$ Humidity : $90 \sim 95\% \text{RH}$ Duration : $1000 + 48 / -0$ hrs Applied current : Rated current Recovery : 1 to 2hrs of recovery under the standard condition after the removal from the test chamber.	

26. Loading at high temperature		
Specified Value	CAL45 Type	$\Delta L/L$: Within $\pm 10\%$
	LHL□□□	
	FBA/FBR	
Test Methods and Remarks	CAL45 Type : Temperature : $85 \pm 2^\circ\text{C}$ Duration : 1000 hrs Applied current : Rated current Recovery : At least 1hr of recovery under the standard removal from test chamber, followed by the measurement within 2hrs.	

27. Low temperature life test		
Specified Value	CAL45 Type	$\Delta L/L$: Within $\pm 10\%$
	LHL□□□	Appearance : No abnormality Inductance change : Within $\pm 10\%$ Q change : Within $\pm 30\%$ (LHLP : only $\Delta L/L$)
	FBA/FBR	
Test Methods and Remarks	CAL45 Type : Temperature : $-25 \pm 2^\circ\text{C}$ Duration : 1000 hrs Recovery : At least 1hr of recovery under the standard removal from test chamber, followed by the measurement within 2hrs. LHL□□□ : Temperature : $-40 \pm 3^\circ\text{C}$ Duration : $1000 + 48 / -0$ hrs Recovery : 1 to 2hrs of recovery under the standard condition after the removal from the test chamber.	

28. High temperature life test		
Specified Value	CAL45 Type	
	LHL□□□	Appearance : No abnormality Inductance change : Within $\pm 10\%$ Q change : Within $\pm 30\%$ (LHLP : only $\Delta L/L$)
	FBA/FBR	
Test Methods and Remarks	LHL□□□ : Temperature : $105 \pm 2^\circ\text{C}$ Duration : $1000 + 48 / -0$ hrs Recovery : 1 to 2hrs of recovery under the standard condition after the removal from the test chamber.	

▶ This catalog contains the typical specification only due to the limitation of space. When you consider the purchase of our products, please check our specification. For details of each product (characteristics graph, reliability information, precautions for use, and so on), see our Web site (<http://www.ty-top.com/>).

AXIAL LEADED INDUCTORS (CAL Type)、 RADIAL LEADED INDUCTORS (LH Type)、 LEADED FERRITE BEAD INDUCTORS (FB Series A Type/R Type)

■ PRECAUTIONS

1. Circuit Design

Precautions	<p>◆Operating environment</p> <p>1. The products described in this specification are intended for use in general electronic equipment,(office supply equipment, telecommunications systems, measuring equipment, and household equipment). They are not intended for use in mission-critical equipment or systems requiring special quality and high reliability (traffic systems, safety equipment, aerospace systems, nuclear control systems and medical equipment including life-support systems,) where product failure might result in loss of life, injury or damage. For such uses, contact TAIYO YUDEN Sales Department in advance.</p>
-------------	--

2. PCB Design

Precautions	<p>◆Design</p> <p>1. Please design insertion pitches as matching to that of leads of the component on PCBs.</p>
Technical considerations	<p>◆Design</p> <p>1. When Inductors are mounted onto a PC board, hole dimensions on the board should match the lead pitch of the component, if not, it will cause breakage of the terminals or cracking of terminal roots covered with resin as excess stress travels through the terminal legs.</p>

3. Considerations for automatic placement

Precautions	<p>◆Adjustment of mounting machine</p> <p>1. Excessive impact load should not be imposed on the products when mounting onto the PC boards. 2. Mounting and soldering conditions should be checked beforehand.</p>
Technical considerations	<p>◆Adjustment of mounting machine</p> <p>1. When installing products, care should be taken not to apply distortion stress as it may deform the products.</p>

4. Soldering

Precautions	<p>◆Wave soldering</p> <p>1. Please refer to the specifications in the catalog for a wave soldering. 2. Do not immerse the entire inductor in the flux during the soldering operation.</p> <p>◆Lead free soldering</p> <p>1. When using products with lead free soldering, we request to use them after confirming adhesion, temperature of resistance to soldering heat, soldering etc sufficiently.</p> <p>◆Recommended conditions for using a soldering iron:</p> <ul style="list-style-type: none"> •Put the soldering iron on the land-pattern. •Soldering iron's temperature – Below 350°C •Duration – 3 seconds or less •The soldering iron should not directly touch the inductor. <p>◆Reflow soldering</p> <p>1. As for reflow soldering, please contact our sales staff.</p>
Technical considerations	<p>◆Lead free soldering</p> <p>1. If products are used beyond the range of the recommended conditions, heat stresses may deform the products, and consequently degrade the reliability of the products.</p> <p>◆Recommended conditions for using a soldering iron</p> <p>If products are used beyond the range of the recommended conditions, heat stresses may deform the products, and consequently degrade the reliability of the products.</p>

5. Cleaning

Precautions	<p>◆Cleaning conditions</p> <p>1. CAL type, LH type Please do not do cleaning by a supersonic wave.</p>
Technical considerations	<p>◆Cleaning conditions</p> <p>1. CAL type, LH type, If washing by supersonic waves, supersonic waves may deform products.</p>

▶ This catalog contains the typical specification only due to the limitation of space. When you consider the purchase of our products, please check our specification. For details of each product (characteristics graph, reliability information, precautions for use, and so on), see our Web site (<http://www.ty-top.com/>).

6. Handling	
Precautions	<ul style="list-style-type: none"> ◆Handling <ol style="list-style-type: none"> 1. Keep the inductors away from all magnets and magnetic objects. ◆Mechanical considerations <ol style="list-style-type: none"> 1. Please do not give the inductors any excessive mechanical shocks. 2. LH type <ul style="list-style-type: none"> If inductors are dropped onto the floor or a hard surface they should not be used. ◆Packing <ol style="list-style-type: none"> 1. Please do not give the inductors any excessive mechanical shocks. <ul style="list-style-type: none"> In loading, please pay attention to handling indication mentioned in a packing box (a loading direction / number of maximum loading / fragile item).
Technical considerations	<ul style="list-style-type: none"> ◆Handling <ol style="list-style-type: none"> 1. There is a case that a characteristic varies with magnetic influence. ◆Mechanical considerations <ol style="list-style-type: none"> 1. There is a case to be damaged by a mechanical shock. 2. LH type <ul style="list-style-type: none"> There is a case to be broken by a fall. ◆Packing <ol style="list-style-type: none"> 1. There is a case that a lead wire could be deformed by a fall or an excessive shock.
7. Storage conditions	
Precautions	<ul style="list-style-type: none"> ◆Storage <ol style="list-style-type: none"> 1. To maintain the solderability of terminal electrodes and to keep the packing material in good condition, temperature and humidity in the storage area should be controlled. <ul style="list-style-type: none"> Recommended conditions •Ambient temperature 0~40°C •Humidity Below 70% RH <p>The ambient temperature must be kept below 30°C. Even under ideal storage conditions, solderability of products electrodes may decrease as time passes.</p> <p>For this reason, inductors should be used within one year from the time of delivery.</p> <p>In case of storage over 6 months, solderability shall be checked before actual usage.</p>
Technical considerations	<ul style="list-style-type: none"> ◆Storage <ol style="list-style-type: none"> 1. Under a high temperature and humidity environment, problems such as reduced solderability caused by oxidation of terminal electrodes and deterioration of taping/packaging materials may take place.