



■ Features :

- AC input range selectable by switch
- Protections: Short circuit / Overload / Over voltage
- Cooling by free air convection
- LED indicator for power on
- 100% full load burn-in test
- High efficiency, long life and high reliability
- 2 years warranty



SPECIFICATION

MODEL		NES-150-3.3	NES-150-5	NES-150-7.5	NES-150-9	NES-150-12	NES-150-15	NES-150-24	NES-150-48
OUTPUT	DC VOLTAGE	3.3V	5V	7.5V	9V	12V	15V	24V	48V
	RATED CURRENT	30A	26A	20A	16.7A	12.5A	10A	6.5A	3.3A
	CURRENT RANGE	0 ~ 30A	0 ~ 26A	0 ~ 20A	0 ~ 16.7A	0 ~ 12.5A	0 ~ 10A	0 ~ 6.5A	0 ~ 3.3A
	RATED POWER	99W	130W	150W	150W	150W	150W	156W	158.4W
	RIPPLE & NOISE (max.) Note.2	80mVp-p	80mVp-p	120mVp-p	120mVp-p	120mVp-p	120mVp-p	120mVp-p	200mVp-p
	VOLTAGE ADJ. RANGE	3.2 ~ 3.5V	4.75 ~ 5.5V	7.13 ~ 8.3V	8.55 ~ 9.9V	11.4 ~ 13.5V	14.25 ~ 16.5V	22.8 ~ 27.6V	45.6 ~ 52.8V
	VOLTAGE TOLERANCE Note.3	±3.0%	±2.0%	±1.0%	±1.0%	±1.0%	±1.0%	±1.0%	±1.0%
	LINE REGULATION Note.4	±0.5%	±0.5%	±0.5%	±0.5%	±0.5%	±0.5%	±0.5%	±0.5%
	LOAD REGULATION Note.5	±2.0%	±1.0%	±0.5%	±0.5%	±0.5%	±0.5%	±0.5%	±0.5%
	SETUP, RISE TIME Note.8	800ms, 20ms/230VAC 1200ms, 30ms/115VAC at full load							
HOLD UP TIME (Typ.)	24ms/230VAC 20ms/115VAC at full load								
INPUT	VOLTAGE RANGE	90 ~ 132VAC / 180 ~ 264VAC selected by switch 254 ~ 373VDC							
	FREQUENCY RANGE	47 ~ 63Hz							
	EFFICIENCY (Typ.)	73%	78%	80%	83%	83%	83%	86%	86%
	AC CURRENT (Typ.)	3A/115VAC		2A/230VAC					
	INRUSH CURRENT (Typ.)	COLD START 45A/230VAC							
	LEAKAGE CURRENT	<2mA / 240VAC							
PROTECTION	OVERLOAD	110 ~ 150% rated output power Protection type : Hiccup mode, recovers automatically after fault condition is removed							
	OVER VOLTAGE	3.8 ~ 4.65V	5.75 ~ 6.75V	8.6 ~ 10.1V	10.4 ~ 12.2V	13.8 ~ 16.2V	17.25 ~ 20.25V	27.6 ~ 32.4V	55.2 ~ 64.8V
ENVIRONMENT	WORKING TEMP.	-20 ~ +60°C (Refer to output load derating curve)							
	WORKING HUMIDITY	20 ~ 90% RH non-condensing							
	STORAGE TEMP., HUMIDITY	-40 ~ +85°C, 10 ~ 95% RH							
	TEMP. COEFFICIENT	±0.03%/°C (0 ~ 50°C)							
	VIBRATION	10 ~ 500Hz, 2G 10min./1cycle, period for 60min. each along X, Y, Z axes							
SAFETY & EMC (Note 7)	SAFETY STANDARDS Note.6	UL60950-1, TUV EN60950-1, GB4943.1:2011 approved							
	WITHSTAND VOLTAGE	I/P-O/P:3KVAC I/P-FG:2KVAC O/P-FG:0.5KVAC							
	ISOLATION RESISTANCE	I/P-O/P, I/P-FG, O/P-FG:100M Ohms/500VDC 70% RH							
	EMI CONDUCTION & RADIATION	Compliance to EN55032 (CISPR32) Class B, GB9254 CLASS B							
	HARMONIC CURRENT	Compliance to EN61000-3-2, -3, GB17625.1							
EMS IMMUNITY	Compliance to EN61000-4-2, 3, 4, 5, 6, 8, 11, ENV50204, EN55024, EN61000-6-1, heavy industry level, criteria A								
OTHERS	MTBF	433.3Khrs min. MIL-HDBK-217F (25°C)							
	DIMENSION	199*98*38mm (L*W*H)							
	PACKING	0.7Kg; 20pcs/15Kg/0.72CUFT							
NOTE	<ol style="list-style-type: none"> 1. All parameters NOT specially mentioned are measured at 230VAC input, rated load and 25°C of ambient temperature. 2. Ripple & noise are measured at 20MHz of bandwidth by using a 12" twisted pair-wire terminated with a 0.1uf & 47uf parallel capacitor. 3. Tolerance : includes set up tolerance, line regulation and load regulation. 4. Line regulation is measured from low line to high line at rated load. 5. Load regulation is measured from 0% to 100% rated load. 6. For the request of GB4943.1, the power supply is only suitable for use in the altitude 2000m below and the non tropical climate condition. 7. The power supply is considered a component which will be installed into a final equipment. The final equipment must be re-confirmed that it still meets EMC directives. For guidance on how to perform these EMC tests, please refer to "EMI testing of component power supplies." (as available on http://www.meanwell.com) 8. Length of set up time is measured at cold first start. Turning ON/OFF the power supply very quickly may lead to increase of the set up time. 								

■ Mechanical Specification

Case No. 902 Unit:mm

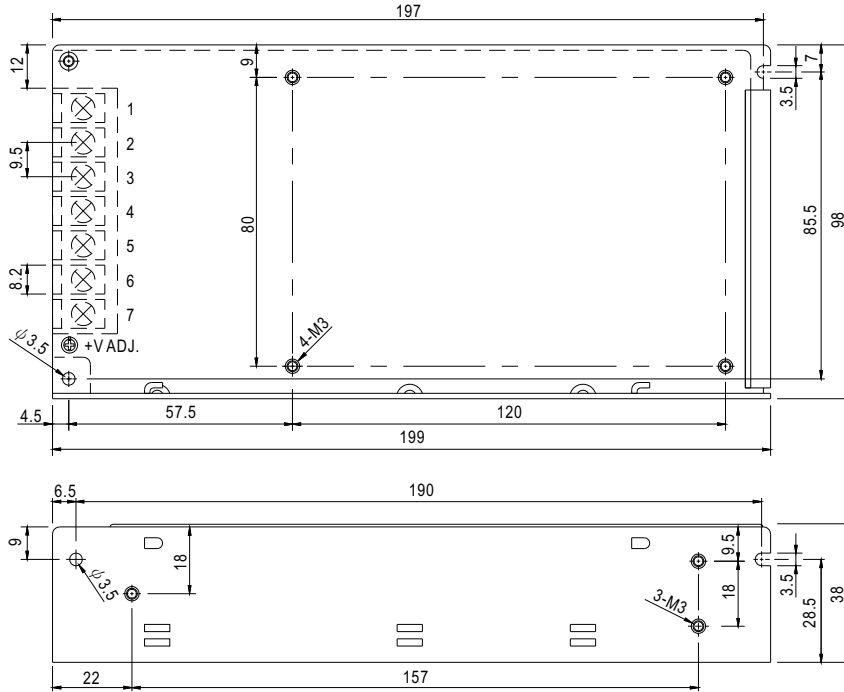

Terminal Pin No. Assignment

Pin No.	Assignment	Pin No.	Assignment
1	AC/L	4,5	DC OUTPUT -V
2	AC/N	6,7	DC OUTPUT +V
3	FG \perp		

■ Block Diagram

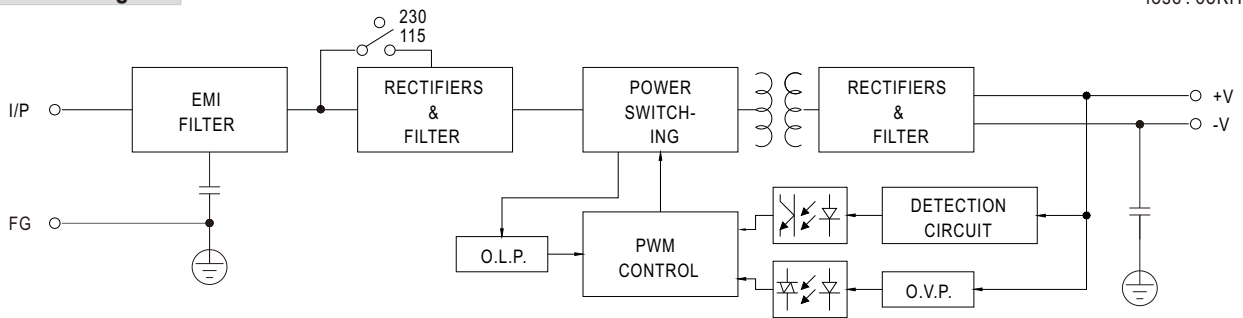

■ Derating Curve

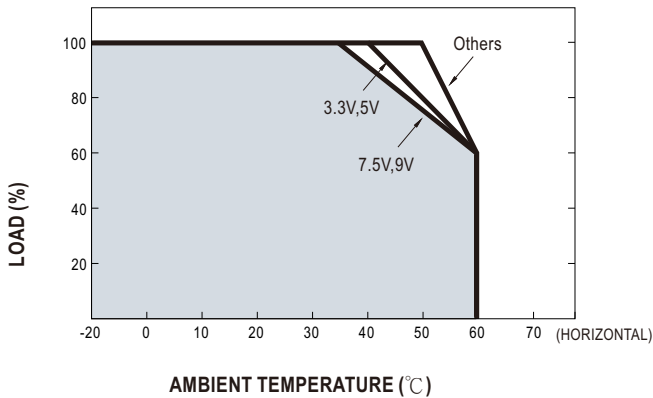

■ Static Characteristics

