



GaAs pHEMT MMIC LOW NOISE AMPLIFIER, 0.3 - 20 GHz

Typical Applications

The HMC1049LP5E is ideal for:

- Test Instrumentation
- High Linearity Microwave Radios
- VSAT & SATCOM
- Military & Space

Features

- Noise Figure: 1.8 dB
- P1dB Output Power: +14.5 dBm
- Psat Output Power: +17.5 dBm
- High Gain: 15 dB
- Output IP3: +29 dBm
- Supply Voltage: Vdd = +7V @ 70 mA
- 50 Ohm Matched Input/Output
- 32 Lead 5x5 mm SMT Package: 25mm²

Functional Diagram

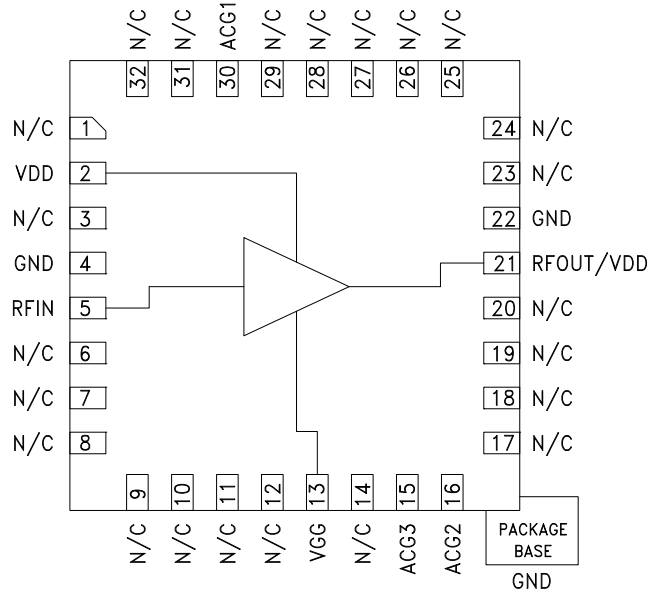

General Description

The HMC1049LP5E is a GaAs MMIC Low Noise Amplifier which operates between 0.3 and 20 GHz. This LNA provides 15 dB of small signal gain, 1.8 dB noise figure, and output IP3 of 29 dBm, while requiring only 70 mA from a +7 V supply. The P1dB output power of 14.5 dBm enables the LNA to function as a LO driver for balanced, I/Q or image reject mixers. Vdd can be applied to pin 2 or pin 21. Pin 21 will require a bias tee. The HMC1049LP5E amplifier I/Os are internally matched to 50 Ohms and the device is supplied in a compact, leadless QFN 5x5 mm surface mount package.

Electrical Specifications, $T_A = +25^\circ C$, Vdd = +7V, Idd = 70 mA [1]

| Parameter | Min. | Typ. | Max. | Min. | Typ. | Max. | Min. | Typ. | Max. | Units |
|--|------|---------|------|--------|-------|------|---------|-------|------|-------|
| Frequency Range | | 0.3 - 1 | | 1 - 14 | | | 14 - 20 | | | GHz |
| Gain | 13.5 | 16.5 | | 12 | 15 | | 10 | 13 | | dB |
| Gain Variation Over Temperature | | 0.006 | | | 0.019 | | | 0.017 | | dB/°C |
| Noise Figure | | 2.5 | 3.5 | | 1.8 | 2.5 | | 2.7 | 4.0 | dB |
| Input Return Loss | | 15 | | | 13 | | | 14 | | dB |
| Output Return Loss | | 8 | | | 15 | | | 13 | | dB |
| Output Power for 1 dB Compression (P1dB) | | 15 | | | 14.5 | | | 13 | | dBm |
| Saturated Output Power (Psat) | | 18 | | | 17.5 | | | 16 | | dBm |
| Output Third Order Intercept (IP3) [2] | | 31 | | | 29 | | | 26 | | dBm |
| Total Supply Current | | 70 | | | 70 | | | 70 | | mA |

[1] Adjust Vgg between -2 to 0V to achieve Idd = 70 mA typical.

[2] Measurement taken at Pout / tone = +8 dBm.



GaAs pHEMT MMIC LOW NOISE AMPLIFIER, 0.3 - 20 GHz

Data taken with Vdd applied to pin 2.

Broadband Gain & Return Loss

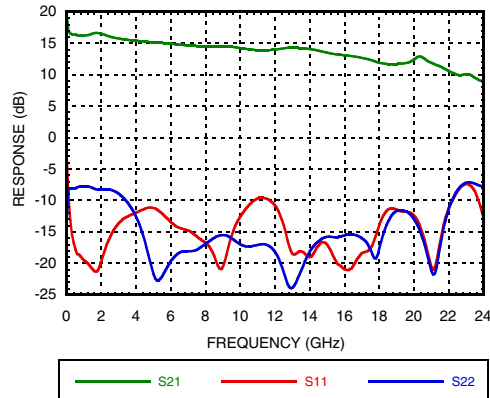

Gain vs. Temperature

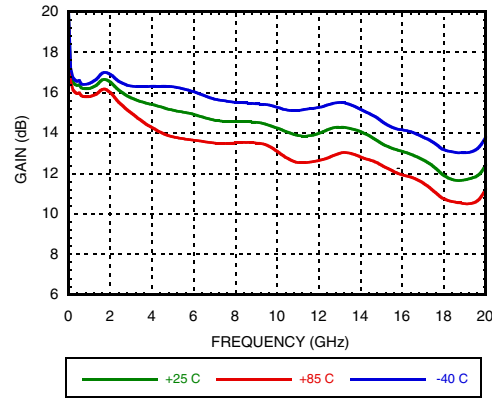

Input Return Loss vs. Temperature

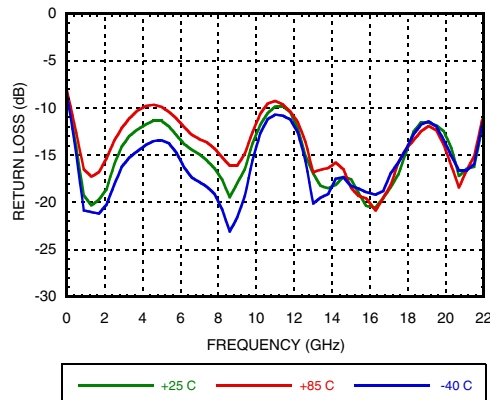

Output Return Loss vs. Temperature

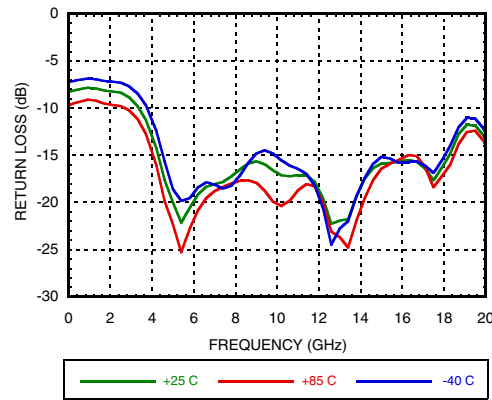

Noise Figure vs. Temperature

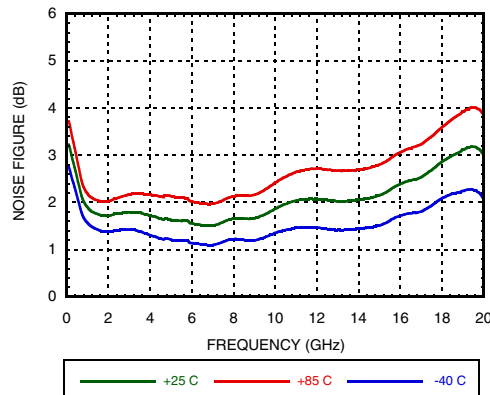

Noise Figure vs. Temperature, Low Frequency

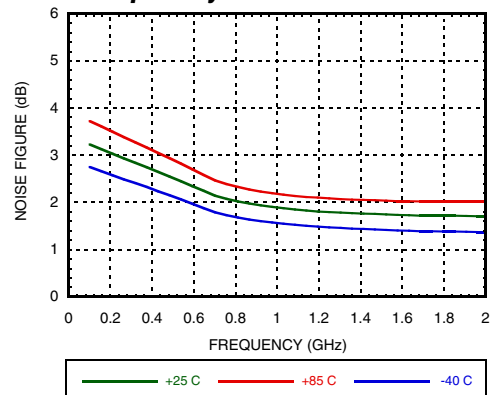

Information furnished by Analog Devices is believed to be accurate and reliable. However, no responsibility is assumed by Analog Devices for its use, nor for any infringements of patents or other rights of third parties that may result from its use. Specifications subject to change without notice. No license is granted by implication or otherwise under any patent or patent rights of Analog Devices. Trademarks and registered trademarks are the property of their respective owners.

For price, delivery, and to place orders: Analog Devices, Inc., One Technology Way, P.O. Box 9106, Norwood, MA 02062-9106 Phone: 781-329-4700 • Order online at www.analog.com Application Support: Phone: 1-800-ANALOG-D



**GaAs pHEMT MMIC LOW NOISE
AMPLIFIER, 0.3 - 20 GHz**

Data taken with Vdd applied to pin 2.

Noise Figure vs. Vdd

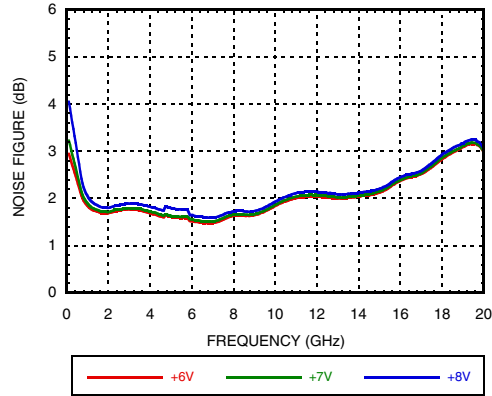

Noise Figure vs. Idd

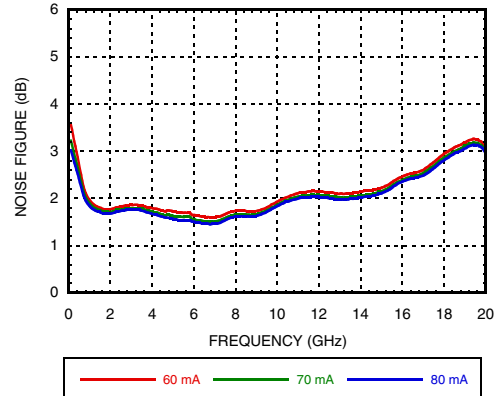

Output IP3 vs. Temperature

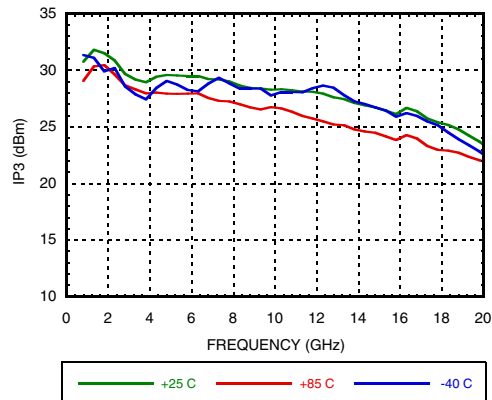

P1dB vs. Temperature

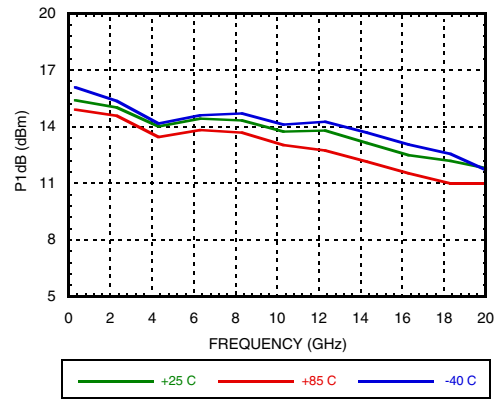

Psat vs. Temperature

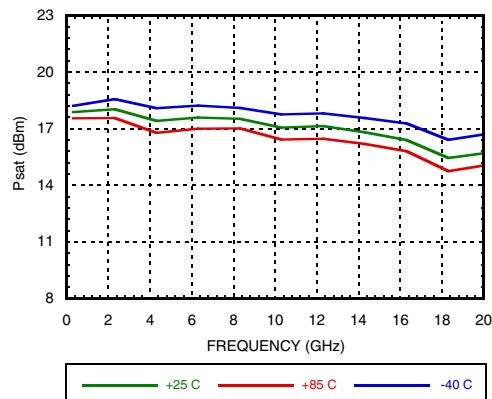

P1dB vs. Vdd

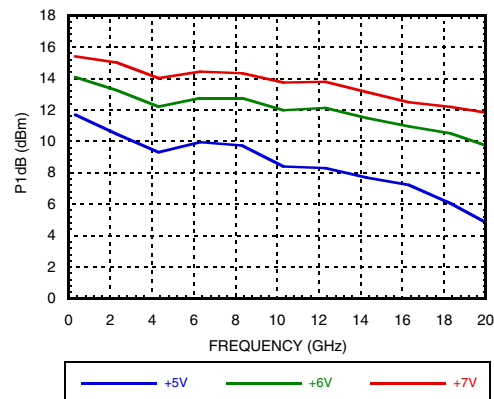

Information furnished by Analog Devices is believed to be accurate and reliable. However, no responsibility is assumed by Analog Devices for its use, nor for any infringements of patents or other rights of third parties that may result from its use. Specifications subject to change without notice. No license is granted by implication or otherwise under any patent or patent rights of Analog Devices. Trademarks and registered trademarks are the property of their respective owners.

For price, delivery, and to place orders: Analog Devices, Inc., One Technology Way, P.O. Box 9106, Norwood, MA 02062-9106 Phone: 781-329-4700 • Order online at www.analog.com Application Support: Phone: 1-800-ANALOG-D



GaAs pHEMT MMIC LOW NOISE AMPLIFIER, 0.3 - 20 GHz

Data taken with Vdd applied to pin 2.

Psat vs. Vdd

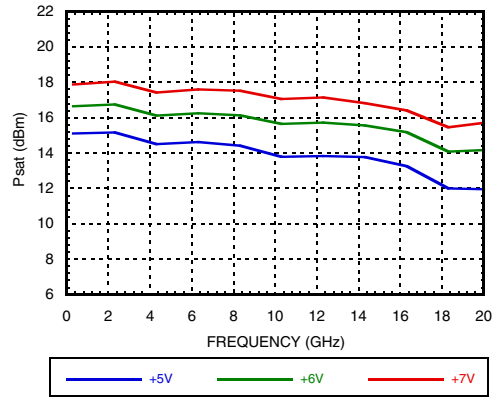

Reverse Isolation vs. Temperature

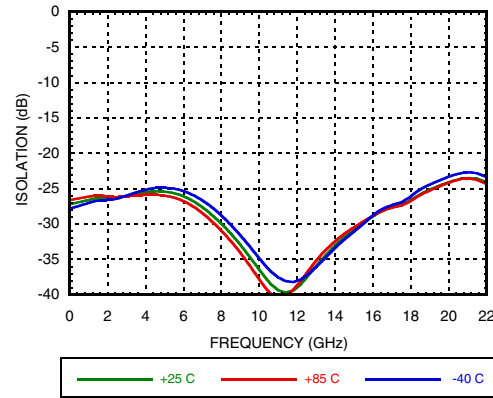

Power Compression @ 2 GHz

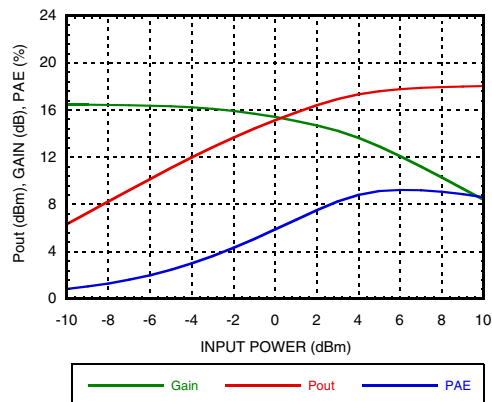

Power Compression @ 10 GHz

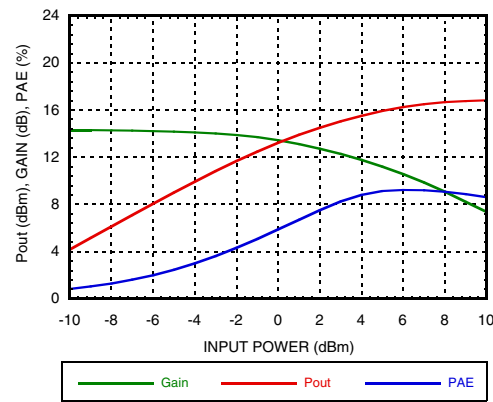

Power Compression @ 18 GHz

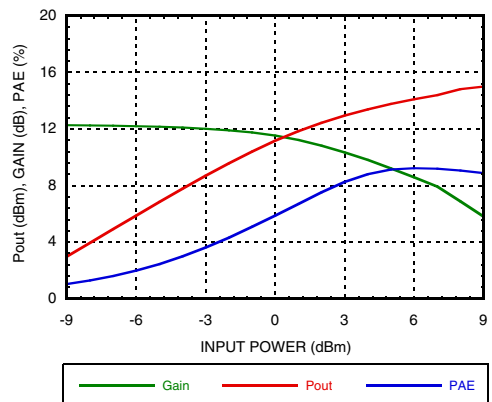

Noise Figure, Gain & Power vs. Supply Voltage @ 12 GHz

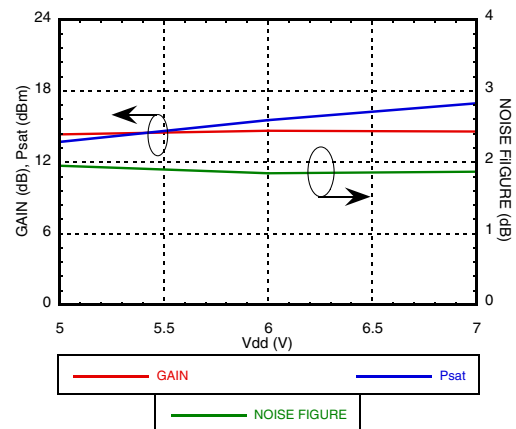

Information furnished by Analog Devices is believed to be accurate and reliable. However, no responsibility is assumed by Analog Devices for its use, nor for any infringements of patents or other rights of third parties that may result from its use. Specifications subject to change without notice. No license is granted by implication or otherwise under any patent or patent rights of Analog Devices. Trademarks and registered trademarks are the property of their respective owners.

For price, delivery, and to place orders: Analog Devices, Inc., One Technology Way, P.O. Box 9106, Norwood, MA 02062-9106 Phone: 781-329-4700 • Order online at www.analog.com Application Support: Phone: 1-800-ANALOG-D



**GaAs pHEMT MMIC LOW NOISE
AMPLIFIER, 0.3 - 20 GHz**

Data taken with Vdd applied to pin 2.

**Noise Figure, Gain & Power vs.
Supply Current @ 12 GHz**

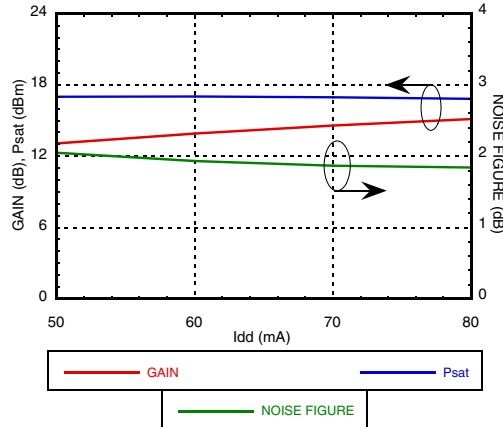

Information furnished by Analog Devices is believed to be accurate and reliable. However, no responsibility is assumed by Analog Devices for its use, nor for any infringements of patents or other rights of third parties that may result from its use. Specifications subject to change without notice. No license is granted by implication or otherwise under any patent or patent rights of Analog Devices. Trademarks and registered trademarks are the property of their respective owners.

For price, delivery, and to place orders: Analog Devices, Inc., One Technology Way, P.O. Box 9106, Norwood, MA 02062-9106 Phone: 781-329-4700 • Order online at www.analog.com Application Support: Phone: 1-800-ANALOG-D



GaAs pHEMT MMIC LOW NOISE AMPLIFIER, 0.3 - 20 GHz

Data taken with Vdd applied to bias tee at pin 21.

Broadband Gain & Return Loss [1]

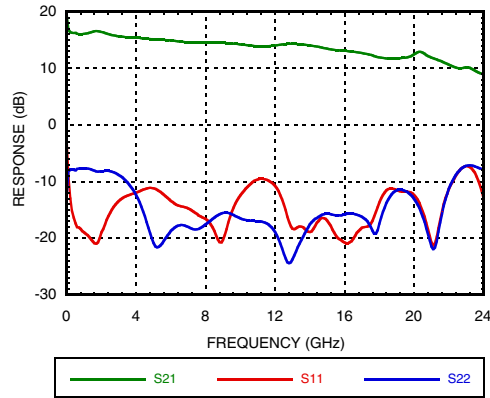

Gain vs. Temperature [1]

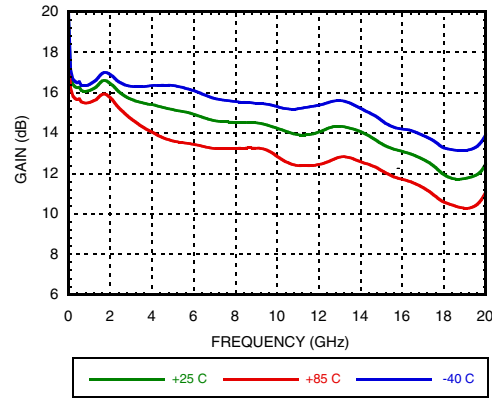

Noise Figure vs. Temperature [1]

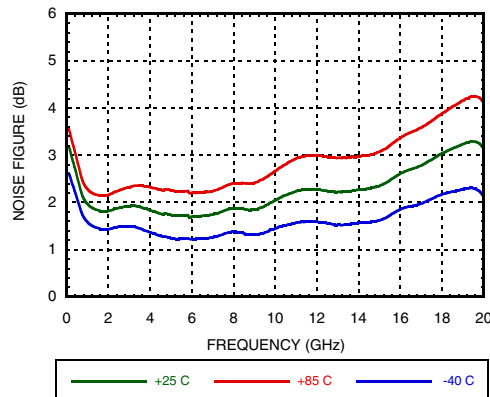

Output IP3 vs. Temperature [1]

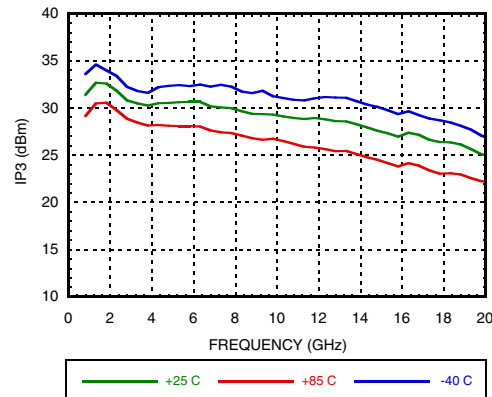

P1dB vs. Temperature [1]

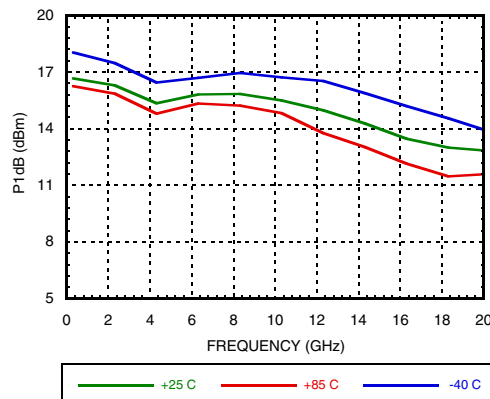

Psat vs. Temperature [1]

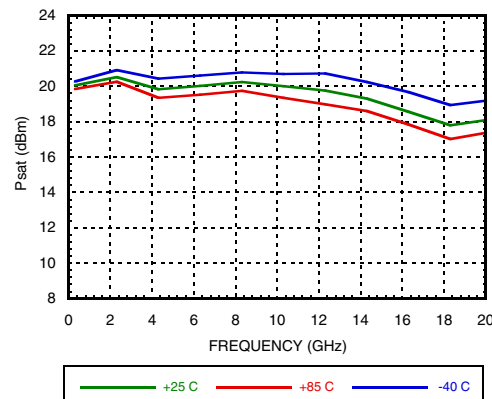

[1] Vdd= +4V, supply to bias tee.



GaAs pHEMT MMIC LOW NOISE AMPLIFIER, 0.3 - 20 GHz

Absolute Maximum Ratings

| | |
|---|----------------|
| Drain Bias Voltage (Vdd) | +10V |
| Drain Bias Voltage (RF out / Vdd) | +7V |
| RF Input Power | +18 dBm |
| Gate Bias Voltage, Vgg1 | -2V to +0.2V |
| Channel Temperature | 175 °C |
| Continuous P _{diss} (T = 85 °C) (derate 37.1 mW/°C above 85 °C) | 3.34 W |
| Thermal Resistance (Channel to die bottom) | 26.9 °C/W |
| Storage Temperature | -65 to +150 °C |
| Operating Temperature | -40 to +85 °C |
| ESD Sensitivity (HBM) | Class 1A |

Typical Supply Current vs. Vdd

| Vdd (V) | I _{dd} (mA) |
|---------|----------------------|
| +5 | 70 |
| +6 | 70 |
| +7 | 70 |

Adjust Vgg1 to achieve I_{dd} = 70 mA



**ELECTROSTATIC SENSITIVE DEVICE
OBSERVE HANDLING PRECAUTIONS**

Outline Drawing

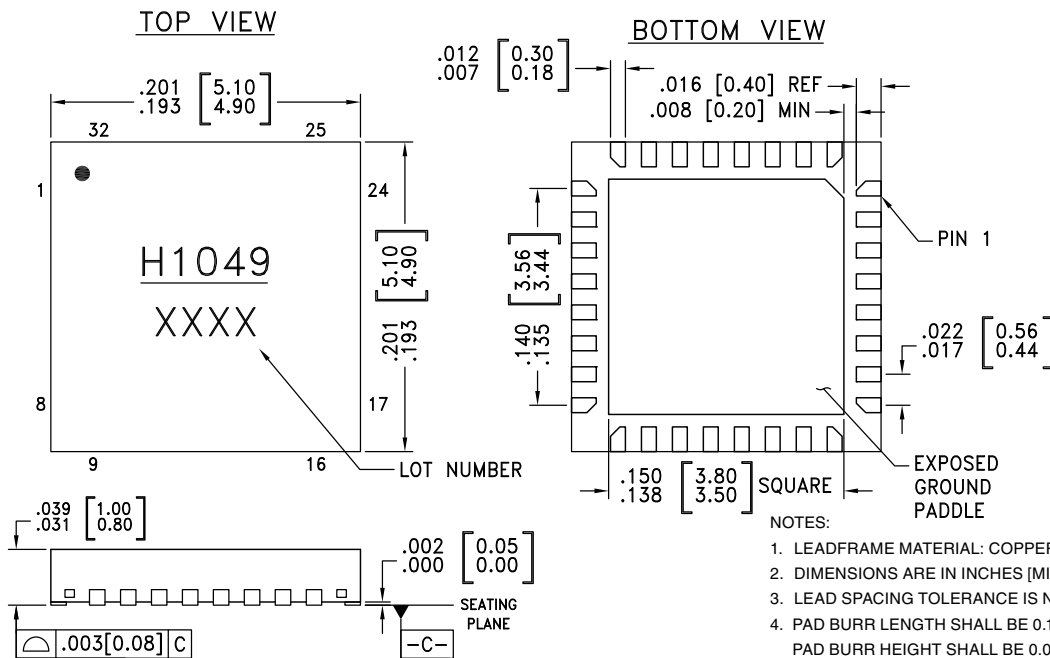

NOTES:

1. LEADFRAME MATERIAL: COPPER ALLOY
2. DIMENSIONS ARE IN INCHES [MILLIMETERS].
3. LEAD SPACING TOLERANCE IS NON-CUMULATIVE
4. PAD BURR LENGTH SHALL BE 0.15mm MAXIMUM.
PAD BURR HEIGHT SHALL BE 0.05mm MAXIMUM.
5. PACKAGE WARP SHALL NOT EXCEED 0.05mm.
6. ALL GROUND LEADS AND GROUND PADDLE MUST BE SOLDERED TO PCB RF GROUND.
7. REFER TO HITTITE APPLICATION NOTE FOR SUGGESTED PCB LAND PATTERN.

Package Information

| Part Number | Package Body Material | Lead Finish | MSL Rating [2] | Package Marking [1] |
|-------------|--|---------------|----------------|---------------------|
| HMC1049LP5E | RoHS-compliant Low Stress Injection Molded Plastic | 100% matte Sn | MSL1 | H1049 XXXX |



[1] 4-Digit lot number XXXX

[2] Max peak reflow temperature of 260 °C

GaAs pHEMT MMIC LOW NOISE AMPLIFIER, 0.3 - 20 GHz

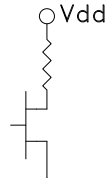
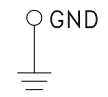
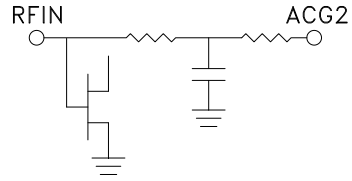
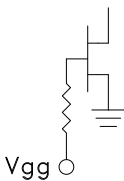
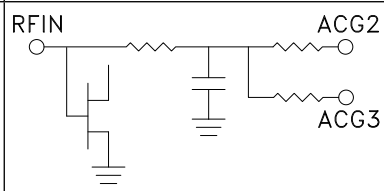

Pin Descriptions

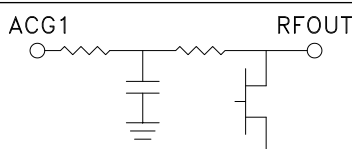
| Pad Number | Function | Description | Interface Schematic |
|--------------------------------------|------------|--|---|
| 1, 3, 6-12, 14, 17-20, 23-29, 31, 32 | N/C | No connection required. The pins are not connected internally; however, all data shown herein was measured with these pins connected to RF/DC ground externally. | |
| 2 | Vdd | Power supply voltage for the amplifier. External bypass capacitors 100 pF, and 0.01 uF are required. |  |
| 4, 22 | GND | These pins and the exposed ground paddle must be connected to RF/DC ground. |  |
| 5 | RFIN | This pin is DC coupled and matched to 50 Ohms. |  |
| 13 | Vgg | Gate control for amplifier. External bypass capacitors 100 pF, 0.01uF, and 4.7 uF are required. Adjust voltage to achieve typical I _{dd} . |  |
| 15, 16 | ACG3, ACG2 | Low frequency termination. External bypass capacitors 100 pF are required. |  |
| 21 | RFOUT/Vdd | This pin is DC coupled and matched to 50 Ohms. |  |
| 30 | ACG1 | Low frequency termination. External bypass capacitor 100 pF required. |  |



**GaAs pHEMT MMIC LOW NOISE
AMPLIFIER, 0.3 - 20 GHz**

Evaluation PCB

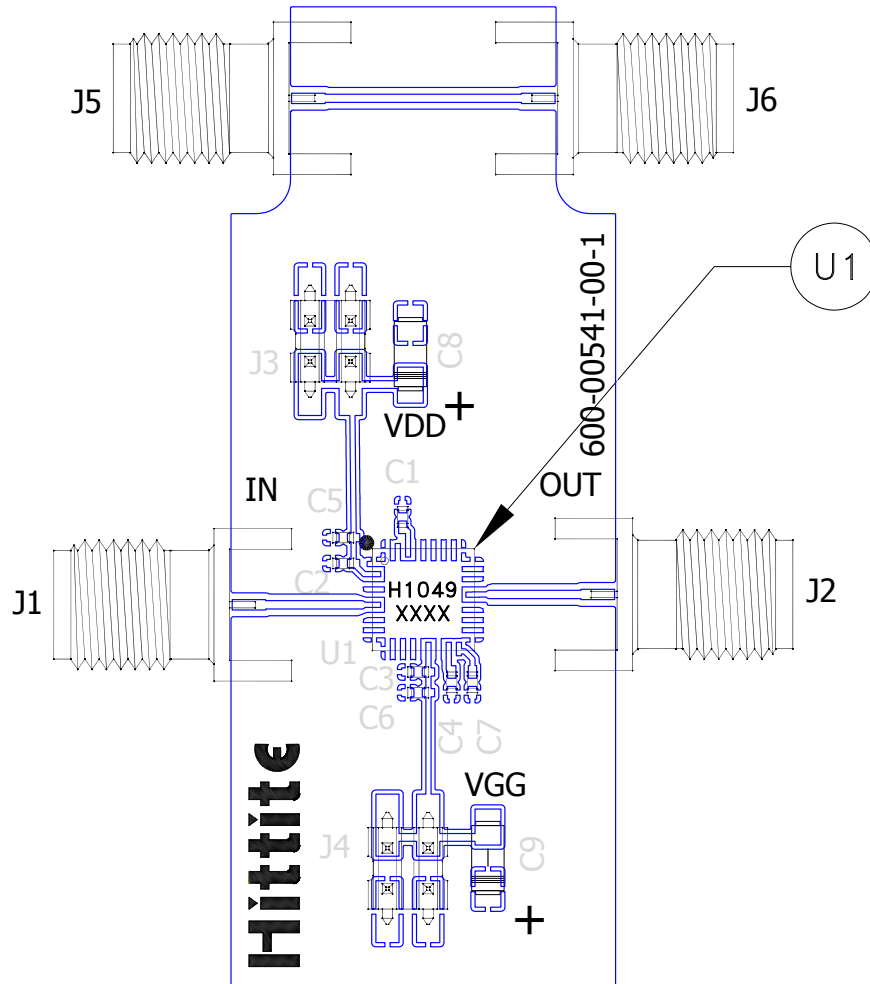

List of Materials for Evaluation PCB EV1HMC1049LP5 [1]

| Item | Description |
|----------------|--------------------------------|
| J1, J2, J5, J6 | PCB Mount SMA RF Connector. |
| J3, J4 | DC Pins. |
| C1 - C4 | 100 pF Capacitor, 0402 Pkg. |
| C5 - C7 | 10000 pF Capacitor, 0402 Pkg. |
| C8 - C9 | 4.7 uF Capacitor, Tantalum. |
| U1 | HMC1049LP5E. |
| PCB [1] | 600-00541-00-1 Evaluation PCB. |

The circuit board used in the application should use RF circuit design techniques. Signal lines should have 50 Ohm impedance while the package ground leads and exposed paddle should be connected directly to the ground plane similar to that shown. A sufficient number of via holes should be used to connect the top and bottom ground planes. The evaluation circuit board shown is available from Hittite upon request.

[1] Circuit Board Material: Rogers 4350 or Arlon 25FR

**GaAs pHEMT MMIC LOW NOISE
AMPLIFIER, 0.3 - 20 GHz**



Evaluation PCB Schematic

