

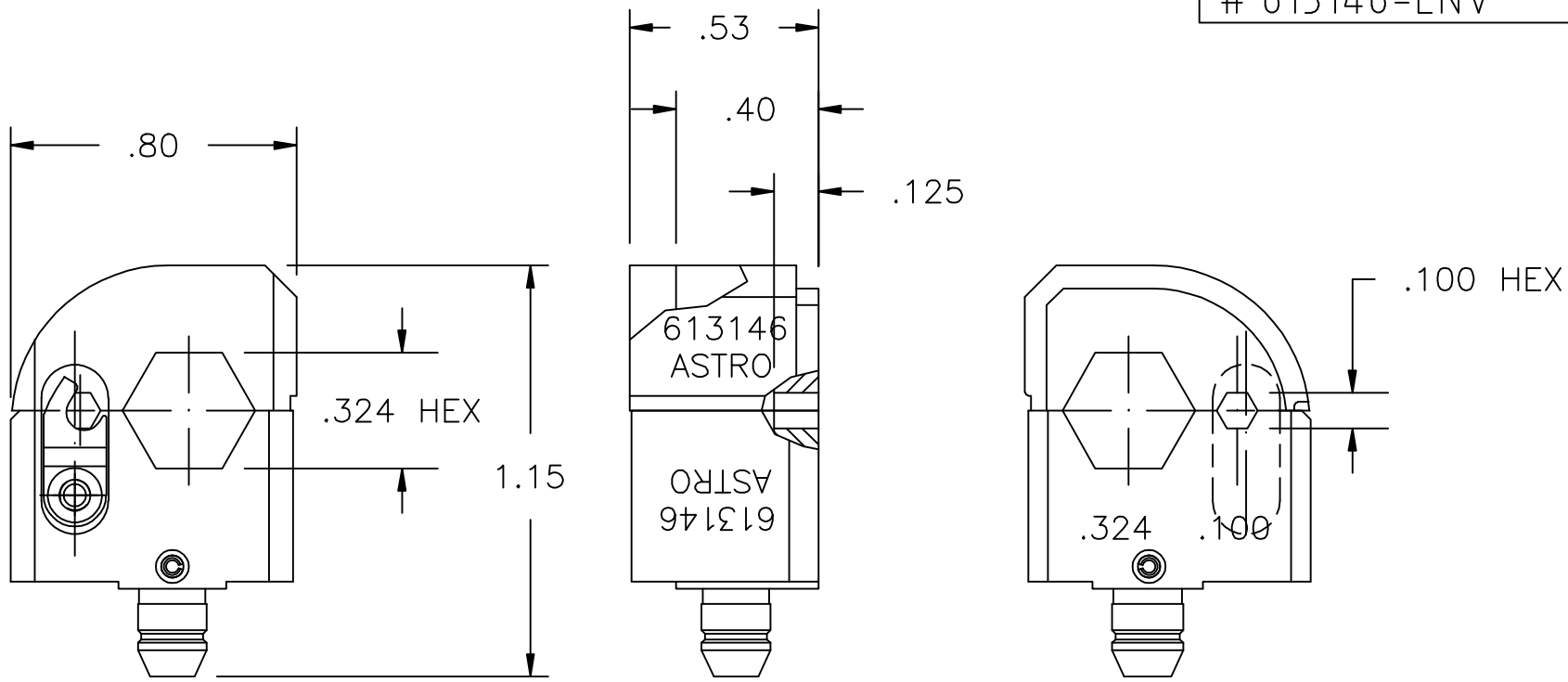

613146-ENV



UNCONTROLLED DOCUMENT
WILL NOT BE UPDATED

2. USE WITH 612648 TOOL FRAME.

NOTES: 1. THIS IS AN AUTOCAD DRAWING DO NOT CHANGE MANUALLY.

					THESE DRAWINGS, SPECIFICATIONS OR OTHER DATA ARE AND REMAIN, THE PROPERTY OF ASTRO TOOL CORP. AND MUST BE RETURNED UPON REQUEST. THEY CONTAIN INFORMATION OWNED AND/OR DEVELOPED BY ASTRO AT ITS OWN PRIVATE EXPENSE AND MAY NOT BE USED, DUPLICATED OR DISCLOSED TO OTHERS, IN WHOLE OR IN PART FOR DESIGN, MANUFACTURE OR PROCUREMENT WITHOUT THE WRITTEN PERMISSION OF ASTRO TOOL CORP. EACH AND EVERY TIME.	SCALE: N.T.S. DWN BY: DY0 DATE: 09-29-11 APPROVED:	UNLESS OTHERWISE SPECIFIED: DECIMALS: .XXX ± .005 .XX ± .010 .X ± .030 ANGLES: ± 1°	 CAGE 58164 21615 S.W. TUALATIN VALLEY HWY., BEAVERTON OR 97006 DESCRIPTION: ENVELOPE DRAWING: 613146 DIE SET
A	NEW RELEASE.	DY0	09-29-11	MMK				PART NO. A 613146-ENV
REV.	DESCRIPTION	BY	DATE	APR.				