

DO NOT SCALE FROM THIS PRINT

FIG 2
CABLE STRIPPING DIMENSIONS PER CONFIGURATIONS (SEE TABLE 1)(SEE NOTES 12,13,14,15)

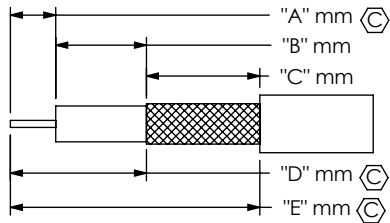

TABLE 2: FINAL ASSEMBLY LENGTH TOLERANCE

LENGTH	TOLERANCE
0030-0200 [3.92-7.87]	+3.0 [.12]/-0.0 [.00]
0200-0500 [7.87-19.69]	+5.0 [.20]/-0.0 [.00]
0500-1100 [19.69-43.30]	+10.0 [.40]/-0.0 [.00]
>1100 [43.30]	± 1%

TABLE 1					
STYLE	CABLE STRIPPING DIMENSIONS			CABLE CUT LENGTH	HI POT
	"A"	"D"	"E"	SUBTRACTOR	DCV
-MH1RP	1.2 [0.05]	2.5 [0.10]	3.5 [0.14]	0.5 [0.02]	200
-MH3RP	1.0 [0.04]	1.4 [0.06]	2.4 [0.09]	0.5 [0.02]	200
-01BJ1	2.5 [0.10]	3.1 [0.12]	11.5 [0.45]	9.5 [0.37]	200
-01BJ2	2.5 [0.10]	3.1 [0.12]	11.5 [0.45]	9.5 [0.37]	200
-01SB1	2.5 [0.10]	3.1 [0.12]	11.5 [0.45]	9.5 [0.37]	200
-01SR1	2.5 [0.10]	3.1 [0.12]	11.5 [0.45]	9.5 [0.37]	200
-SING	-	-	-	0.0 [0.00]	200

NOTES:

- ① REPRESENTS A CRITICAL DIMENSION.
- CABLE CUT LENGTH:
= (LENGTH: XXXX) - (SUBTRACTOR FOR END 1) - (SUBTRACTOR FOR END 2).
(SEE TABLE 1 FOR SUBTRACTORS)
- ASSEMBLY TO BE 100% TESTED FOR OPENS & SHORTS.
- ④ ASSEMBLY TO BE 100% HI-POT TESTED PER TABLE 1, THE TEST VOLTAGE FOR THE ASSEMBLY SHOULD BE SET TO THE END OPTION WITH THE LOWEST TEST VOLTAGE RATING.
- ⑤ AFTER FINAL ELECTRICAL TESTS, LABEL EACH CABLE ASSEMBLY WITH 1 LABEL -ET. FOR LENGTHS UNDER 100MM, LABEL EACH CABLE WITH DOT MARK.
- CRITICALS ON CONNECTOR PRINTS TO BE CHECKED IN PROCESS.
- FINISHED ASSEMBLIES TO BE PACKAGED PER PACKAGING STANDARD CO-RF-WI-3040-M. -LOCKWASHERS, NUTS, AND GASKETS TO BE SHIPPED UNASSEMBLED.
- CABLE STOCKED IN INCHES, 1 INCH = 25.4 MILLIMETERS.
- CABLE LENGTHS LONGER THAN 1000 MILLIMETERS ARE NOT SUPPORTED BY S.I. TEST DATA.
- MINIMUM BEND RADIUS FOR MH081 = 5.0 [0.20]
MH113 = 6.8 [0.27]
- FOR SING ENDED OR STRIPPED AND TINNED ASSEMBLIES: MAKE A DOUBLE ENDED ASSEMBLY AT TWICE THE CABLE LENGTH AND TEST BEFORE CUTTING ASSEMBLY IN HALF.
- DIM "A", "B", AND "C" HAVE A MINIMUM VALUE OF 0.0mm & A MAXIMUM VALUE OF 9.9mm.
- PRODUCTION OF STRIP AND TIN FOR CENTER DIELECTIC USE: A.
- PRODUCTION OF STRIP AND TIN FOR SHIELD USE: D=A+B.
- PRODUCTION OF STRIP AND TIN FOR JACKET USE: E=A+B+C.
- FOR -RA TO -RA, CONNECTORS SHOULD BOTH BE ORIENTED UP. (SEE SHEET 2, FIG. 4)
- FOR STRIPPED AND TINNED OPTION, ONLY THE CENTER CONDUCTOR IS TINNED.
- IF NO MHXXX OPTION IS LISTED FOR EITHER END, MINIMUM LENGTH IS 100MM.
- JACKET SLUG IS LEFT PARTIALLY INSERTED OVER SHIELD TO PREVENT DAMAGE DURING SHIPPING.

DESIGNED & DIMENSIONED IN MILLIMETERS [INCHES]

MHXXX-XXXXX-XXXXXX-XXXX

CABLE CALLOUT

- 081: CCA-081 (0.81 OD MINIATURE COAX CABLE)
- 113: CCA-113 (1.13 OD MINIATURE COAX CABLE)

END 1 CONNECTOR

- MH1RP: MHF1-P-C-X-RA-CAX (SEE SHEET 2) (081 CABLE TYPE: MHF1-P-C-X-RA-CA3) (113 CABLE TYPE: MHF1-P-C-X-RA-CA4)
- MH3RP: MHF3-P-C-X-RA-CA3 (SEE SHEET 2) (081 CABLE TYPE ONLY)
- 01BJ1: SMA-J-C-X-ST-BHX (SEE SHEET 2) (081 CABLE TYPE: SMA-J-C-X-ST-BH3) (113 CABLE TYPE: SMA-J-C-X-ST-BH4)
- 01BJ2: SMA-J-C-X-ST-BRX (SEE SHEET 2) (081 CABLE TYPE: SMA-J-C-X-ST-BR3) (113 CABLE TYPE: SMA-J-C-X-ST-BR4)
- 01SB1: SMA-J-C-X-ST-SBX (SEE SHEET 2) (081 CABLE TYPE: SMA-J-C-X-ST-SB3) (113 CABLE TYPE: SMA-J-C-X-ST-SB4)
- 01SR1: SMA-J-C-X-ST-SRX (SEE SHEET 2) (081 CABLE TYPE: SMA-J-C-X-ST-SR3) (113 CABLE TYPE: SMA-J-C-X-ST-SR4)

OVERALL CABLE LENGTH
MILLIMETERS OF CABLE
0030 MIN. (SEE NOTE 8, 9 & 18)

END 2 CONNECTOR OR PREPARATION

- MH1RP: MHF1-P-C-X-RA-CAX (SEE SHEET 2) (081 CABLE TYPE: MHF1-P-C-X-RA-CA3) (113 CABLE TYPE: MHF1-P-C-X-RA-CA4)
- MH3RP: MHF3-P-C-X-RA-CA3 (SEE SHEET 2) (081 CABLE TYPE ONLY)
- 01BJ1: SMA-J-C-X-ST-BHX (SEE SHEET 2) (081 CABLE TYPE: SMA-J-C-X-ST-BH3) (113 CABLE TYPE: SMA-J-C-X-ST-BH4)
- 01BJ2: SMA-J-C-X-ST-BRX (SEE SHEET 2) (081 CABLE TYPE: SMA-J-C-X-ST-BR3) (113 CABLE TYPE: SMA-J-C-X-ST-BR4)
- 01SB1: SMA-J-C-X-ST-SBX (SEE SHEET 2) (081 CABLE TYPE: SMA-J-C-X-ST-SB3) (113 CABLE TYPE: SMA-J-C-X-ST-SB4)
- 01SR1: SMA-J-C-X-ST-SRX (SEE SHEET 2) (081 CABLE TYPE: SMA-J-C-X-ST-SR3) (113 CABLE TYPE: SMA-J-C-X-ST-SR4)
- SING: SINGLE ENDED (ONE END ONLY, SEE NOTE 11)
- XXXXXX: STRIPPED AND TINNED (THIS END ONLY- SEE NOTES 11-15, 17, 19 & SHEET 2, FIG 3)

(SEE FIG 2) "C" FORMAT: X.Xmm
(SEE FIG 2) "B" FORMAT: X.Xmm
(SEE FIG 2) "A" FORMAT: X.Xmm

DO NOT LEAVE ANY SPACE BLANK, EACH POSITION MUST CONTAIN A NUMERIC CHARACTER 0 THRU 9.

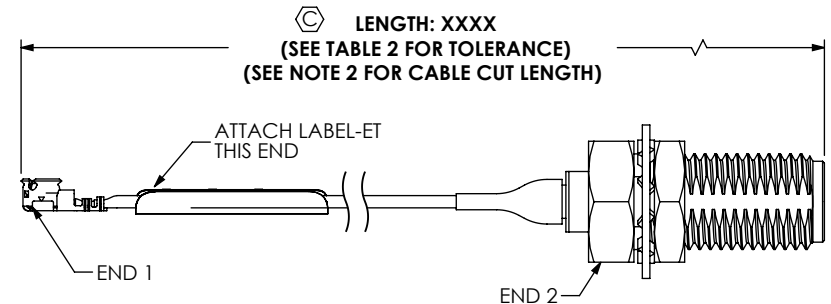

FIG 1
MHXXX-MH1RP-01BJ1-XXXX SHOWN

THIS PRODUCT MANUFACTURED WITH LEAD-FREE PROCESSING

F:\DWG\MISC\MKTG\MHXXX-XXXXX-XXXXXX-XXXX-MKT.SLDDRW

UNLESS OTHERWISE SPECIFIED, DIMENSIONS ARE IN MILLIMETERS [INCHES]. TOLERANCES ARE:
DECIMALS ANGLES
.X: ±0.3 [0.1] 2°
.XX: ±0.13 [0.05]
.XXX: ±0.051 [0.020]

PROPRIETARY NOTE
THIS DOCUMENT CONTAINS CONFIDENTIAL AND PROPRIETARY INFORMATION AND ALL DESIGN, MANUFACTURING, REPRODUCTION, USE, PATENT RIGHTS AND SALES RIGHTS ARE EXPRESSLY RESERVED BY SAMTEC, INC. THIS DOCUMENT SHALL NOT BE DISCLOSED, IN WHOLE OR PART, TO ANY UNAUTHORIZED PERSON OR ENTITY NOR REPRODUCED, TRANSFERRED OR INCORPORATED IN ANY OTHER PROJECT IN ANY MANNER WITHOUT THE EXPRESS WRITTEN CONSENT OF SAMTEC, INC.

samtec
520 PARK EAST BLVD, NEW ALBANY, IN 47150
PHONE: 812-944-6733 FAX: 812-948-5047
e-Mail: info@SAMTEC.com code 55322

DESCRIPTION: MICRO RF CABLE ASSEMBLY

DWG. NO. MHXXX-XXXXX-XXXXXX-XXXX

BY: CUMMINGS 07/26/2005 SHEET 1 OF 3

MATERIAL: DO NOT SCALE DRAWING SHEET SCALE: 2:1
SEE END 1 AND END 2 ASSEMBLY PRINTS

REVISION V

-MH1RP

(RIGHT ANGLE PLUG)

(081 CABLE TYPE USE DRAWING No. MHF1-P-C-X-RA-CA3 FOR ASSEMBLY INSTRUCTIONS)

(113 CABLE TYPE USE DRAWING No. MHF1-P-C-X-RA-CA4 FOR ASSEMBLY INSTRUCTIONS)

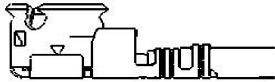

PLATING

3.9µ" MIN. GOLD CENTER CONTACT
 1.9µ" MIN. GOLD OUTER CONTACT
 1.9µ" MIN. GOLD REMAINING METAL PARTS
 (END CONNECTOR P/N: MHF1-P-C-X-RA-CA3)
 OR (END CONNECTOR P/N: MHF1-P-C-X-RA-CA4)

NOTE: ALL CRITICAL DIMENSIONS ON MHF1-P-C-X-RA-CA3 THAT APPLY MUST BE VERIFIED.

-01BJ1

(STRAIGHT BULKHEAD JACK)

(081 CABLE TYPE USE DRAWING No. SMA-J-C-X-ST-BH3 FOR ASSEMBLY INSTRUCTIONS)

(113 CABLE TYPE USE DRAWING No. SMA-J-C-X-ST-BH4 FOR ASSEMBLY INSTRUCTIONS)

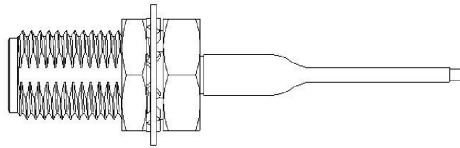

PLATING

30µ" MIN. GOLD CENTER CONTACT
 3µ" MIN. GOLD OUTER CONTACT
 3µ" MIN. GOLD REMAINING METAL PARTS
 (END CONNECTOR P/N: SMA-J-C-H-ST-BH3)
 OR (END CONNECTOR P/N: SMA-J-C-H-ST-BH4)

NOTE: ALL CRITICAL DIMENSIONS ON SMA-J-C-X-ST-BH3 OR SMA-J-C-X-ST-BH4 THAT APPLY MUST BE VERIFIED.

-01SB1

(SEALED STRAIGHT BULKHEAD JACK)

(081 CABLE TYPE USE DRAWING No. SMA-J-C-X-ST-SB3 FOR ASSEMBLY INSTRUCTIONS)

(113 CABLE TYPE USE DRAWING No. SMA-J-C-X-ST-SB4 FOR ASSEMBLY INSTRUCTIONS)

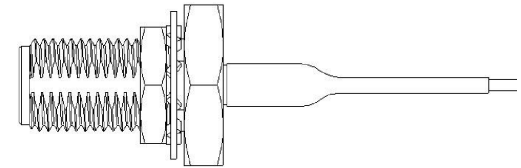

PLATING

30µ" MIN. GOLD CENTER CONTACT
 3µ" MIN. GOLD OUTER CONTACT
 3µ" MIN. GOLD REMAINING METAL PARTS
 (END CONNECTOR P/N: SMA-J-C-H-ST-SB3)
 OR (END CONNECTOR P/N: SMA-J-C-H-ST-SB4)

NOTE: ALL CRITICAL DIMENSIONS ON SMA-J-C-X-ST-SB3 OR SMA-J-C-X-ST-SB4 THAT APPLY MUST BE VERIFIED.

-MH3RP

(RIGHT ANGLE PLUG)

(081 CABLE TYPE USE DRAWING No. MHF3-P-C-X-RA-CA3 FOR ASSEMBLY INSTRUCTIONS)



PLATING

3.9µ" MIN. GOLD CENTER CONTACT
 1.9µ" MIN. GOLD OUTER CONTACT
 1.9µ" MIN. GOLD REMAINING METAL PARTS
 (END CONNECTOR P/N: MHF3-P-C-X-RA-CA3)

NOTE: ALL CRITICAL DIMENSIONS ON MHF3-P-C-X-RA-CA3 THAT APPLY MUST BE VERIFIED.

-01BJ2 (REVERSED POLARITY)

(STRAIGHT BULKHEAD JACK)

(081 CABLE TYPE USE DRAWING No. SMA-J-C-X-ST-BR3 FOR ASSEMBLY INSTRUCTIONS)

(113 CABLE TYPE USE DRAWING No. SMA-J-C-X-ST-BR4 FOR ASSEMBLY INSTRUCTIONS)

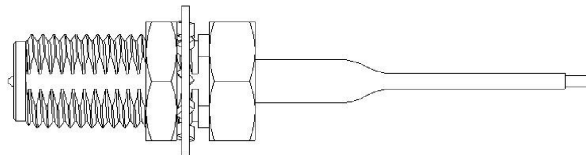

PLATING

30µ" MIN. GOLD CENTER CONTACT
 3µ" MIN. GOLD OUTER CONTACT
 3µ" MIN. GOLD REMAINING METAL PARTS
 (END CONNECTOR P/N: SMA-J-C-H-ST-BR3)
 OR (END CONNECTOR P/N: SMA-J-C-H-ST-BR4)

NOTE: ALL CRITICAL DIMENSIONS ON SMA-J-C-X-ST-BR3 OR SMA-J-C-X-ST-BR4 THAT APPLY MUST BE VERIFIED.

-01SR1 (REVERSED POLARITY)

(SEALED STRAIGHT BULKHEAD JACK)

(081 CABLE TYPE USE DRAWING No. SMA-J-C-X-ST-SR3 FOR ASSEMBLY INSTRUCTIONS)

(113 CABLE TYPE USE DRAWING No. SMA-J-C-X-ST-SR4 FOR ASSEMBLY INSTRUCTIONS)

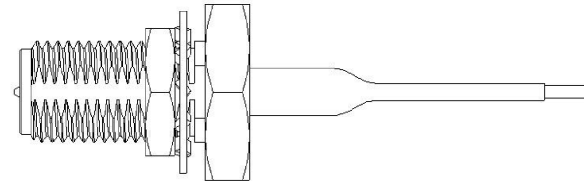

PLATING

30µ" MIN. GOLD CENTER CONTACT
 3µ" MIN. GOLD OUTER CONTACT
 3µ" MIN. GOLD REMAINING METAL PARTS
 (END CONNECTOR P/N: SMA-J-C-H-ST-SR3)
 OR (END CONNECTOR P/N: SMA-J-C-H-ST-SR4)

NOTE: ALL CRITICAL DIMENSIONS ON SMA-J-C-X-ST-SR3 OR SMA-J-C-X-ST-SR4 THAT APPLY MUST BE VERIFIED.

FIG 3

MHXXX-MH1RP-102148-XXXX SHOWN

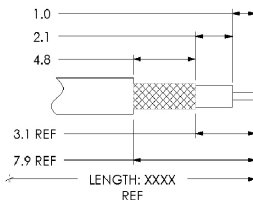
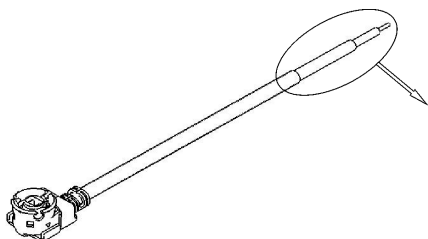
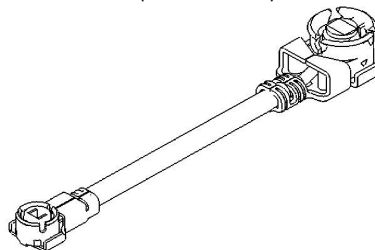

FIG 4

MH081-MH3RP-MH1RP-XXXX SHOWN
 (SEE NOTE 16)



F:\DWG\MISC\MKTG\MHXXX-XXXX-XXXX-XXXX-MKT.SLDDRW

PROPRIETARY NOTE

THIS DOCUMENT CONTAINS CONFIDENTIAL AND PROPRIETARY INFORMATION AND ALL DESIGN, MANUFACTURING, REPRODUCTION, USE, PATENT RIGHTS AND SALES RIGHTS ARE EXPRESSLY RESERVED BY SAMTEC, INC. THIS DOCUMENT SHALL NOT BE DISCLOSED, IN WHOLE OR PART, TO ANY UNAUTHORIZED PERSON OR ENTITY NOR REPRODUCED, TRANSFERRED OR INCORPORATED IN ANY OTHER PROJECT IN ANY MANNER WITHOUT THE EXPRESS WRITTEN CONSENT OF SAMTEC, INC.

DO NOT SCALE DRAWING

SHEET SCALE: 1:1



520 PARK EAST BLVD, NEW ALBANY, IN 47150
 PHONE: 812-944-6733 FAX: 812-948-5047
 e-Mail info@SAMTEC.com code 55322

DESCRIPTION: MICRO RF CABLE ASSEMBLY

DWG. NO. MHXXX-XXXXX-XXXXXX-XXXX

BY: CUMMINGS 07/26/2005 SHEET 2 OF 3

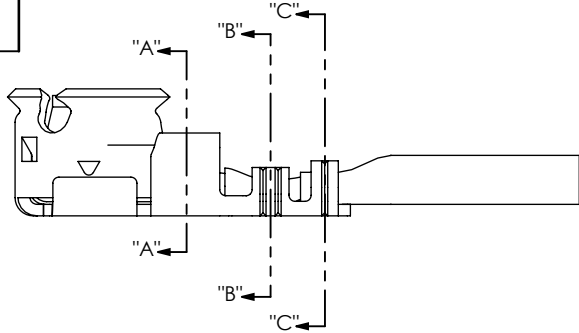

MH081-MH1RP

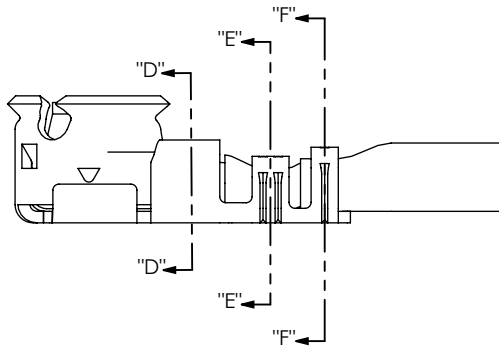

MH113-MH1RP

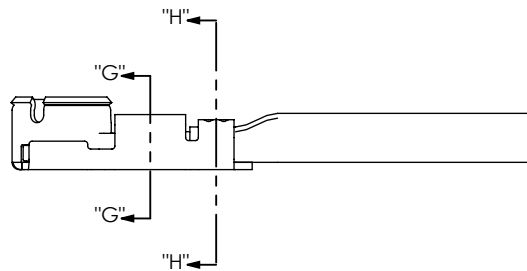

MH081-MH3RP

CRIMP DETAILS

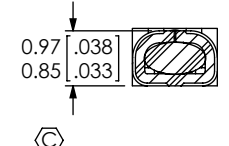
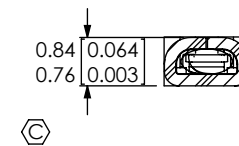
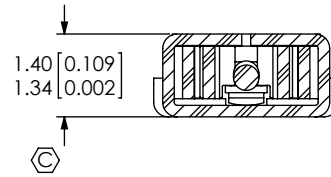

SECTION "A"-~~"A"~~
SCALE 8 : 1

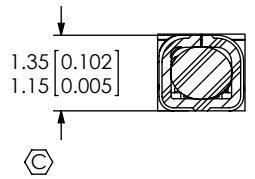
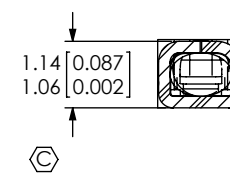
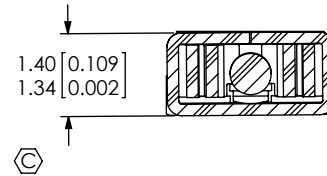

SECTION "D"-~~"D"~~
SCALE 8 : 1

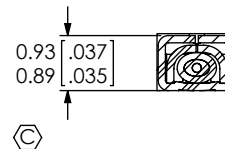

SECTION "G"-~~"G"~~
SCALE 8 : 1

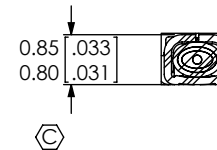

SECTION "H"-~~"H"~~
SCALE 8 : 1

PROPRIETARY NOTE
 * THIS DOCUMENT CONTAINS CONFIDENTIAL AND PROPRIETARY INFORMATION AND ALL DESIGN, MANUFACTURING, REPRODUCTION, USE, PATENT RIGHTS AND SALES RIGHTS ARE EXPRESSLY RESERVED BY SAMTEC, INC. THIS DOCUMENT SHALL NOT BE DISCLOSED, IN WHOLE OR PART, TO ANY UNAUTHORIZED PERSON OR ENTITY NOR REPRODUCED, TRANSFERRED OR INCORPORATED IN ANY OTHER PROJECT IN ANY MANNER WITHOUT THE EXPRESS WRITTEN CONSENT OF SAMTEC, INC.

DO NOT SCALE DRAWING

SHEET SCALE: 2:1



520 PARK EAST BLVD, NEW ALBANY, IN 47150
 PHONE: 812-944-6733 FAX: 812-948-5047
 e-Mail info@SAMTEC.com code 55322

DESCRIPTION: MICRO RF CABLE ASSEMBLY

DWG. NO. MHXXX-XXXXX-XXXXXX-XXXX

BY: CUMMINGS 07/26/2005 SHEET 3 OF 3