

THIS COPY IS PROVIDED ON A RESTRICTED BASIS AND IS NOT TO BE USED IN ANY WAY DETRIMENTAL TO THE INTERESTS OF PANDUIT CORP.

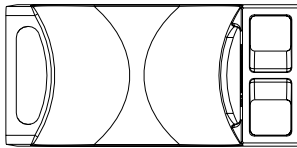

TAK-TY SLOT

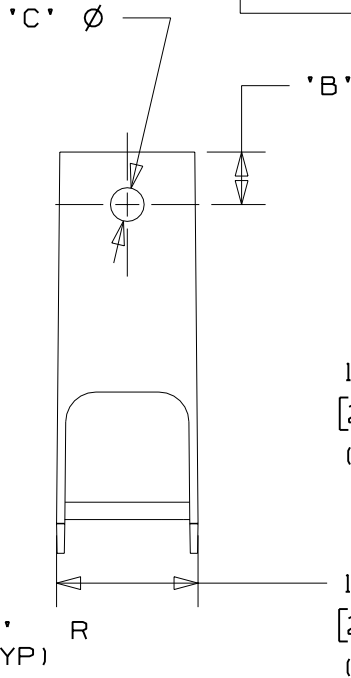
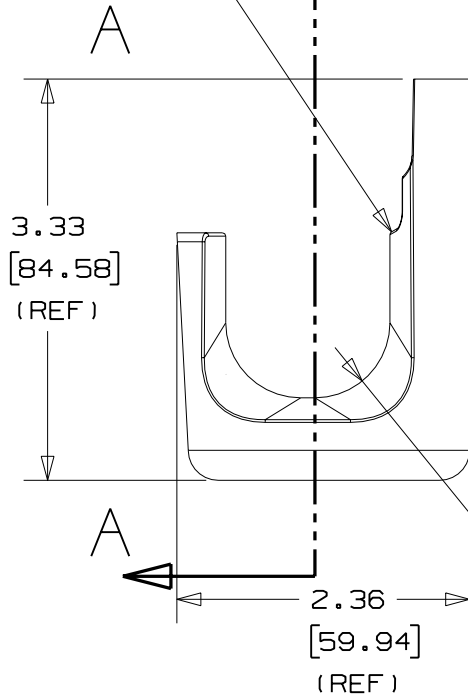

SECTION A-A
(BEND RADIUS CONTROL)

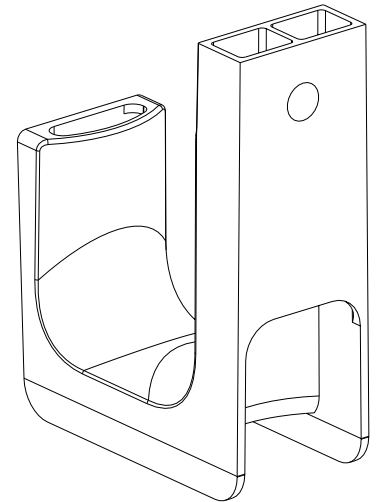

PANDUIT PART NO.	DIMENSIONS			WEIGHT lbs 10 (g) pcs
	'A'	'B'	'C'	
JP131W- ---	0.66 (16.76) (REF)	0.44 (11.18)	0.270 (6.89)	0.45 (204.12)

NOTES:

- SEE CURRENT PRICE SHEET FOR PART NUMBER SUFFIX DESIGNATION FOR PACKAGE SIZE AND PRODUCT COLOR.
- MATERIAL: NYLON 6/6
- PRODUCT IS DESIGNED TO SUPPORT A MAXIMUM 1 5/16" (33.34) DIAMETER BUNDLE, RECOMMENDED MAXIMUM STATIC LOAD: 25 lbs.
- PRODUCT INCORPORATES FEATURES ALLOWING USER TO RETAIN CABLE BUNDLES IN J-PRO J-HOOK WITH TAK-TY CABLE TIES UP TO 3/4" WIDE.
- PRODUCT MARKINGS:
 cULus logo and statement:
 "SUITABLE FOR USE IN AIR HANDLING SPACES IN ACCORDANCE WITH SECTION 300-22 (C) & (D) OF THE NATIONAL ELECTRIC CODE."
 ULC logo and statement:
 "IN ACCORDANCE WITH CAN/ULC S-102.2 IN SINGLE UNITS OR PAIRS, 4 ft (1220mm) MIN. SPACING, FSR=0, SDC=20."

DIMENSIONS IN BRACKETS ARE METRIC [mm]

CAD FILENAME/LAYERS

G03043CC_PB_JP131W_00

PANDUIT

CORP. TINLEY PARK, ILLINOIS

J-PRO J-HOOK
WALL MOUNT
(JP131W- ---)

UNLESS OTHERWISE SPECIFIED,
DIMENSIONAL TOLERANCES ARE:
(.X) ±0.05 (1.3) (.XXX) ±0.010 (0.25)
(.XX) ±0.02 (0.5) ANGLES ± 5°

UNLESS OTHERWISE SPECIFIED,
ALL DIMENSIONS ARE GIVEN
IN INCHES, THIRD ANGLE PROJECTION.

DRAWN BY JAD

MAT'L:

SCALE NONE

DATE 1/19/06

SEE NOTE 2

DRAWING NO.

GB3043CC

DWG
A
SIZE

R	1/19/06	JAD		INITIAL RELEASE	GB3043CC	R			
REV	DATE	BY	CHK	DESCRIPTION	ECN	R	CUST	SUP	