

Darlington

2SB1648

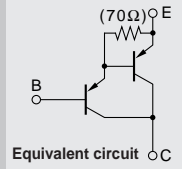

Silicon PNP Epitaxial Planar Transistor (Complement to type 2SD2561)

Application : Audio, Series Regulator and General Purpose

Absolute maximum ratings (Ta=25°C)

Symbol	Ratings	Unit
V _{CB0}	-150	V
V _{CEO}	-150	V
V _{EBO}	-5	V
I _c	-17	A
I _B	-1	A
P _c	200(T _c =25°C)	W
T _J	150	°C
T _{stg}	-55 to +150	°C

Electrical Characteristics (Ta=25°C)

Symbol	Conditions	Ratings	Unit
I _{CB0}	V _{CB} =-150V	-100max	μA
I _{EBO}	V _{EB} =-5V	-100max	μA
V(BR)CEO	I _c =-30mA	-150min	V
h _{FE}	V _{CE} =-4V, I _c =-10A	5000min*	
V _{CE(sat)}	I _c =-10A, I _B =-10mA	-2.5max	V
V _{BE(sat)}	I _c =-10A, I _B =-10mA	-3.0max	V
f _T	V _{CE} =-12V, I _E =2A	45typ	MHz
COB	V _{CB} =-10V, f=1MHz	320typ	pF

*h_{FE} Rank O(5000 to 12000), P(6500 to 20000), Y(15000 to 30000)

Typical Switching Characteristics (Common Emitter)

V _{CC} (V)	R _L (Ω)	I _c (A)	V _{BB1} (V)	V _{BB2} (V)	I _{B1} (mA)	I _{B2} (mA)	t _{on} (μs)	t _{stg} (μs)	t _f (μs)
-40	4	-10	-10	5	-10	10	0.7typ	1.6typ	1.1typ

External Dimensions MT-200

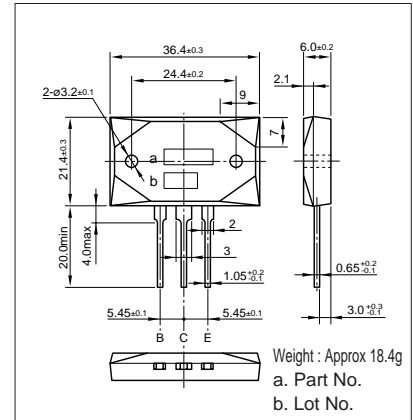

I_c-V_{CE} Characteristics (Typical)

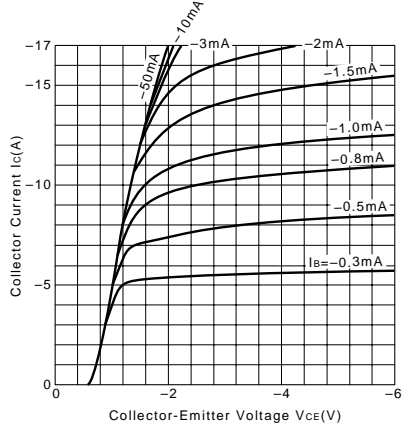

V_{CE(sat)}-I_B Characteristics (Typical)

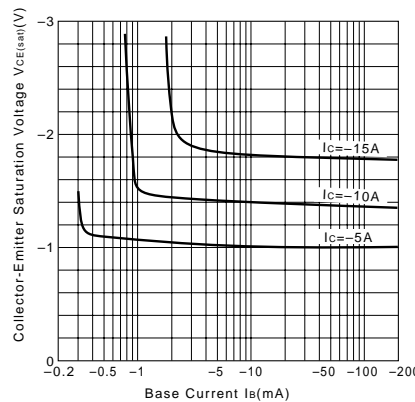

I_c-V_{BE} Temperature Characteristics (Typical)

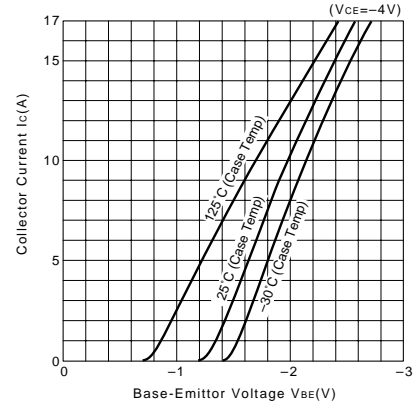

h_{FE}-I_c Characteristics (Typical)

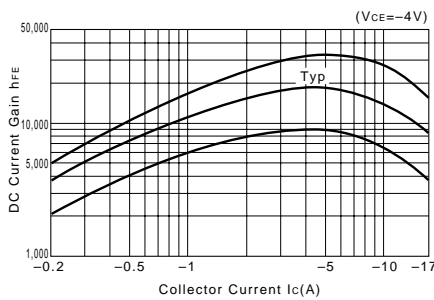

h_{FE}-I_c Temperature Characteristics (Typical)

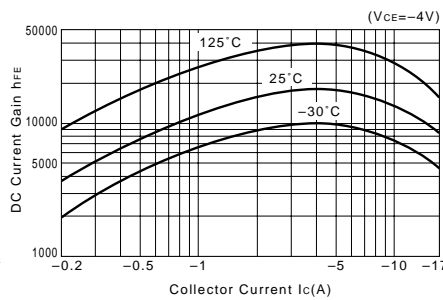

θ_{j-a}-t Characteristics

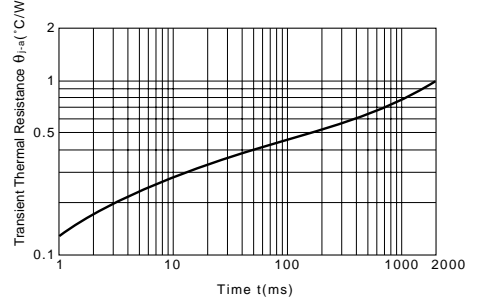

f_T-I_E Characteristics (Typical)

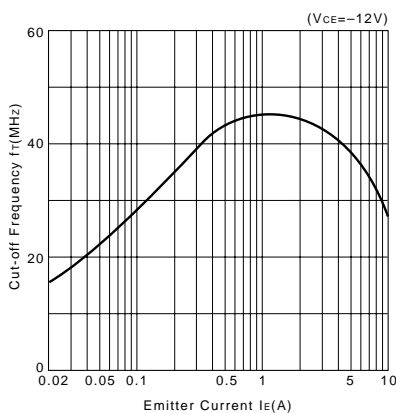

Safe Operating Area (Single Pulse)

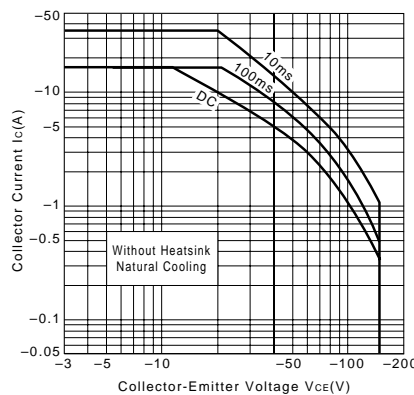

P_c-T_a Derating

