

LOC	DIST	REV	DATE	BY	APPV
		A4	23JAN2013	OL	SZ
		A5	25FEB2014	OL	SZ

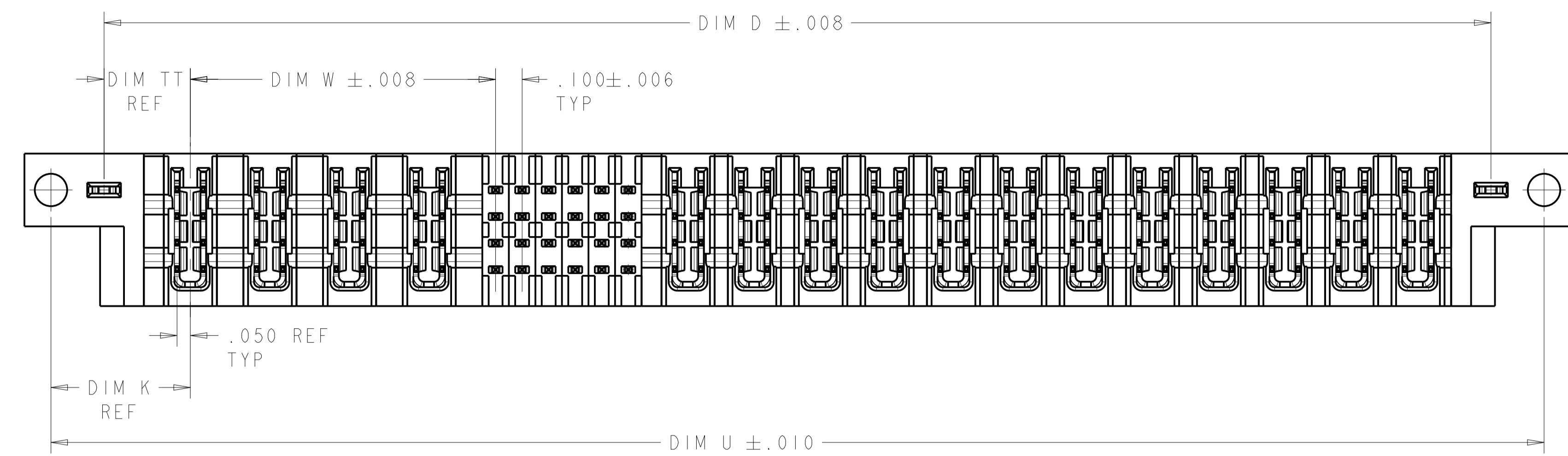

- 1 HEADER HOUSING: THERMO PLASTIC, BLACK, UL94 V-0; CONTACTS AND RETENTION CLIPS: COPPER ALLOY.
- 2 CONTACT PLATING: NOBLE METAL PLATING ON CONTACT FUNCTIONAL AREA OF POWER AND SIGNAL CONTACTS
RETENTION CLIP: .000115 MIN TIN.
- 3 "AMP", PART NUMBER AND DATE CODE MARKED IN THIS AREA. PARTS UNDER 2.50 LONG MAY BE MARKED ON BOTH SIDES.
- 4 DATUM AND BASIC DIMENSIONS ESTABLISHED BY CUSTOMER.
- 5 PCB - ALL HOLE DIAMETERS ARE FINISHED HOLE SIZES.
- 6 APPLIES TO POWER MODULES ON LEFT SIDE OF SIGNAL CAVITIES OF HOUSING.
- 7 APPLIES TO POWER MODULES ON RIGHT SIDE OF SIGNAL CAVITIES OF HOUSING.
- 8 CUSTOMER SUPPLIES (2) #4-40UNC SCREWS, HARDWARE TO BE USED TO MOUNT HEADER ASSEMBLY TO PC BOARD.
- 9 MECHANICAL CONNECTOR KEEP OUT ZONE.

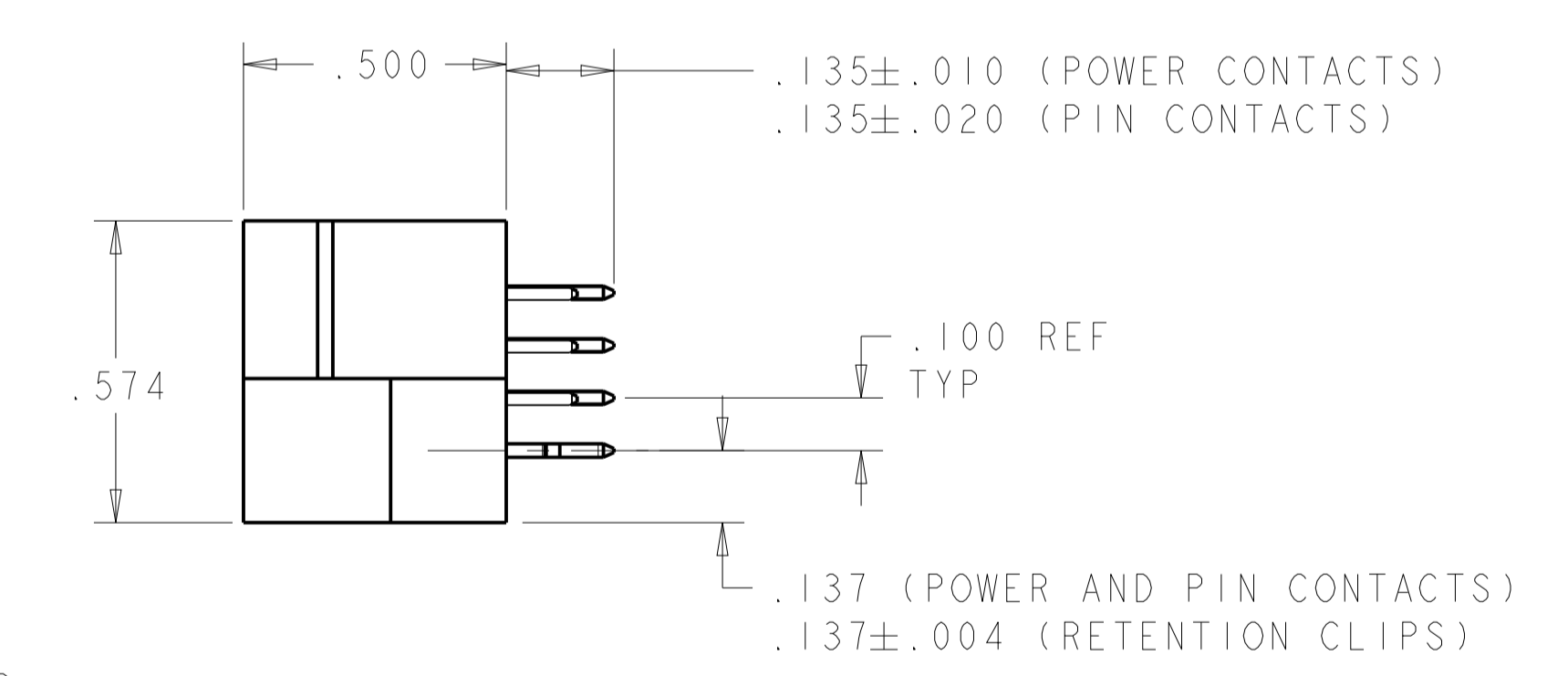
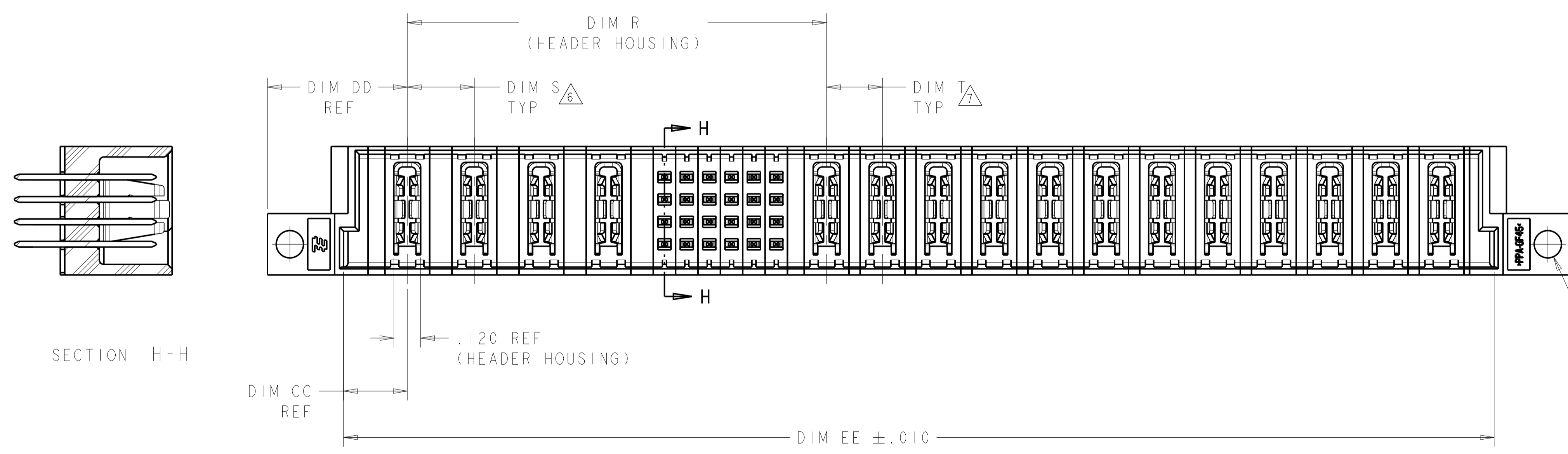
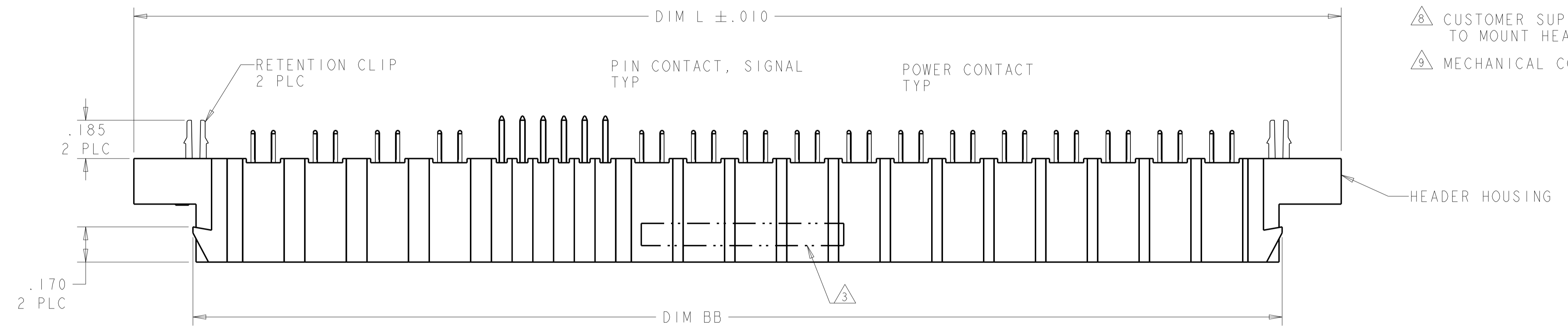

A2	1.120	.550	.210	1.230	.250	.200	1.600	-	-	.700	1.800	.450	1.200	YES	1P + 16S + 1P	6600380-5
A1	2.170	.625	.285	2.280	.325	.550	2.650	.300	.300	1.300	2.850	.525	2.250	YES	2ACP + 24S + 2ACP	6600380-4
	1.920	.575	.235	2.030	.275	.475	2.400	.250	.250	1.200	2.600	.475	2.000	YES	2P + 24S + 2P	6600380-3
	1.420	.575	.235	1.530	.275	.225	1.900	-	-	.950	2.100	.475	1.500	YES	1P + 24S + 1P	6600380-2
	5.145	.625	.285	5.255	.325	1.150	5.625	.250	.300	1.875	5.825	.525	5.225	YES	4ACP + 24S + 12P	6600380-1
	DIM "EE"	DIM "DD"	DIM "CC"	DIM "BB"	DIM "TT"	DIM "W"	DIM "U"	DIM "T"	DIM "S"	DIM "R"	DIM "L"	DIM "K"	DIM "D"	RETENTION CLIP	DESCRIPTION	PART NUMBER

THIS DRAWING IS A CONTROLLED DOCUMENT.

DIMENSIONS: INCH

TOLERANCES UNLESS OTHERWISE SPECIFIED:

0 PLC	±
1 PLC	±
2 PLC	±
3 PLC	±
4 PLC	±
ANGLES	±

MATERIAL: **1**

FINISH: **2**

Customer Drawing

DATE: 22MAR2005

BY: J. McCLINTON

CHECKED: D. TROUT

APPROVED: P. WILBYNE

PRODUCT SPEC: 108-1973

APPLICATION SPEC: 114-13038

WEIGHT: -

SCALE: 3:1

SHEET 1 OF 4

REV A5

STE TE Connectivity

NAME: VERTICAL HEADER ASSEMBLY, W/LATCH RECEIVER, SOLDERTAIL, TYPE PSP, MULTI-BEAM XL

SIZE: A1

CAGE CODE: 6600380

LOC	DIST	REV	DATE	BY	APPV
-	-	1	-	-	-
-		SEE SHEET 1		-	-

PART NUMBER	ROWS	POWER				SIGNAL						POWER											
		P1	P2	P3	P4	1	2	3	4	5	6	P5	P6	P7	P8	P9	P10	P11	P12	P13	P14	P15	P16
6600380-1	D	SZ	SZ	SZ	SZ	SV	SV	SV	SV	SV	SV	SZ	SZ	SZ	SZ	SZ	SZ	SZ	SZ	SZ	SZ	SZ	SZ
	C					SV	SV	SV	SV	SV	SV												
	B					SV	SV	SV	SV	SV	SV												
	A					SV	SV	SV	SV	SV	SV												
4P+24S+12P	HD																					HD	

PART NUMBER	ROWS	POWER		SIGNAL						POWER	
		PI	p2	1	2	3	4	5	6		
6600380-2	D	SZ	SZ	SV	SV	SV	SV	SV	SV	SV	SZ
	C			SV	SV	SV	SV	SV	SV		
	B			SV	SV	SV	SV	SV	SV		
	A			SV	SV	SV	SV	SV	SV		
1P+24S+1P	HD										HD

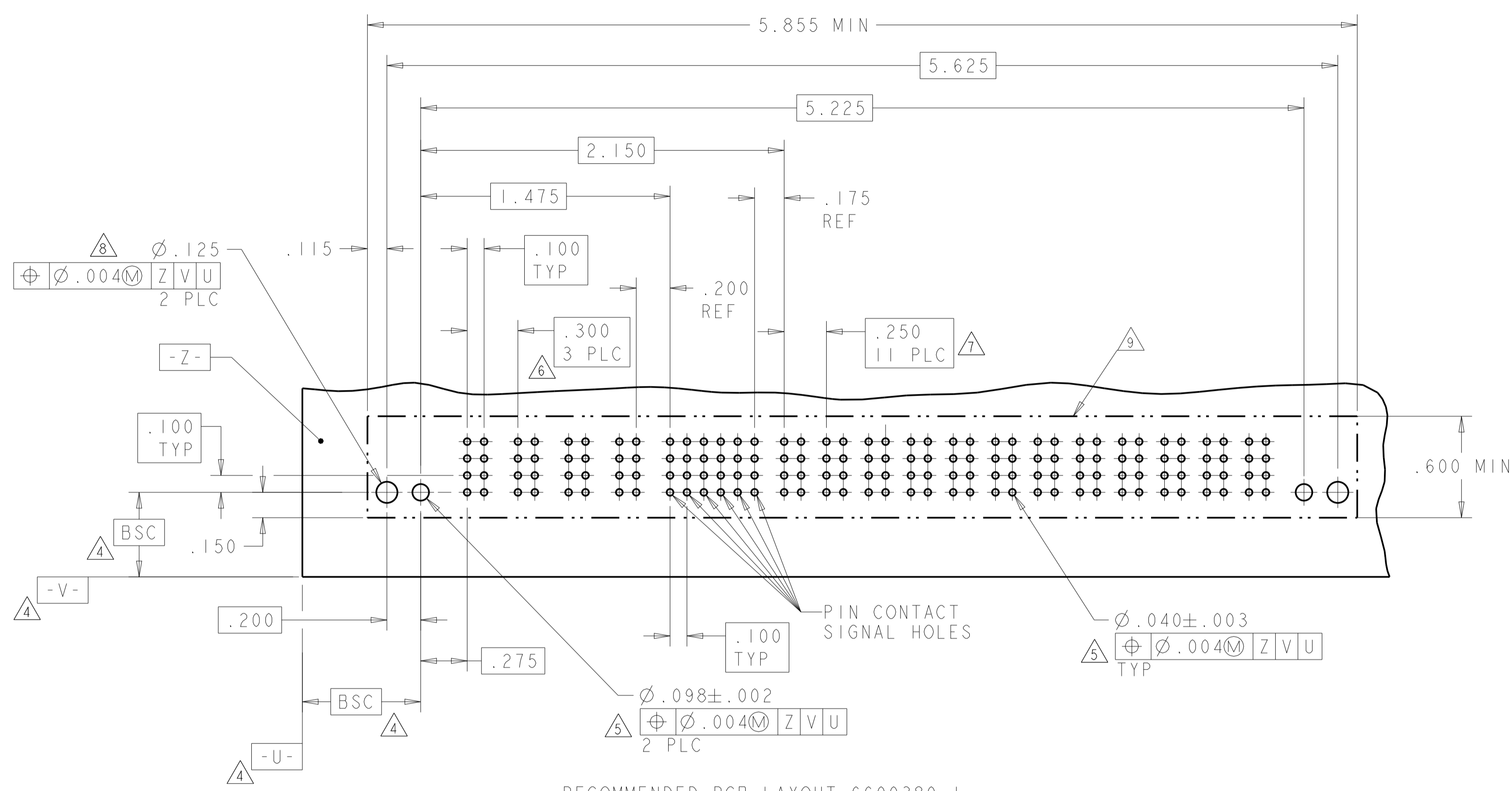

RECOMMENDED PCB LAYOUT 6600380-1
 SCALE 2:1

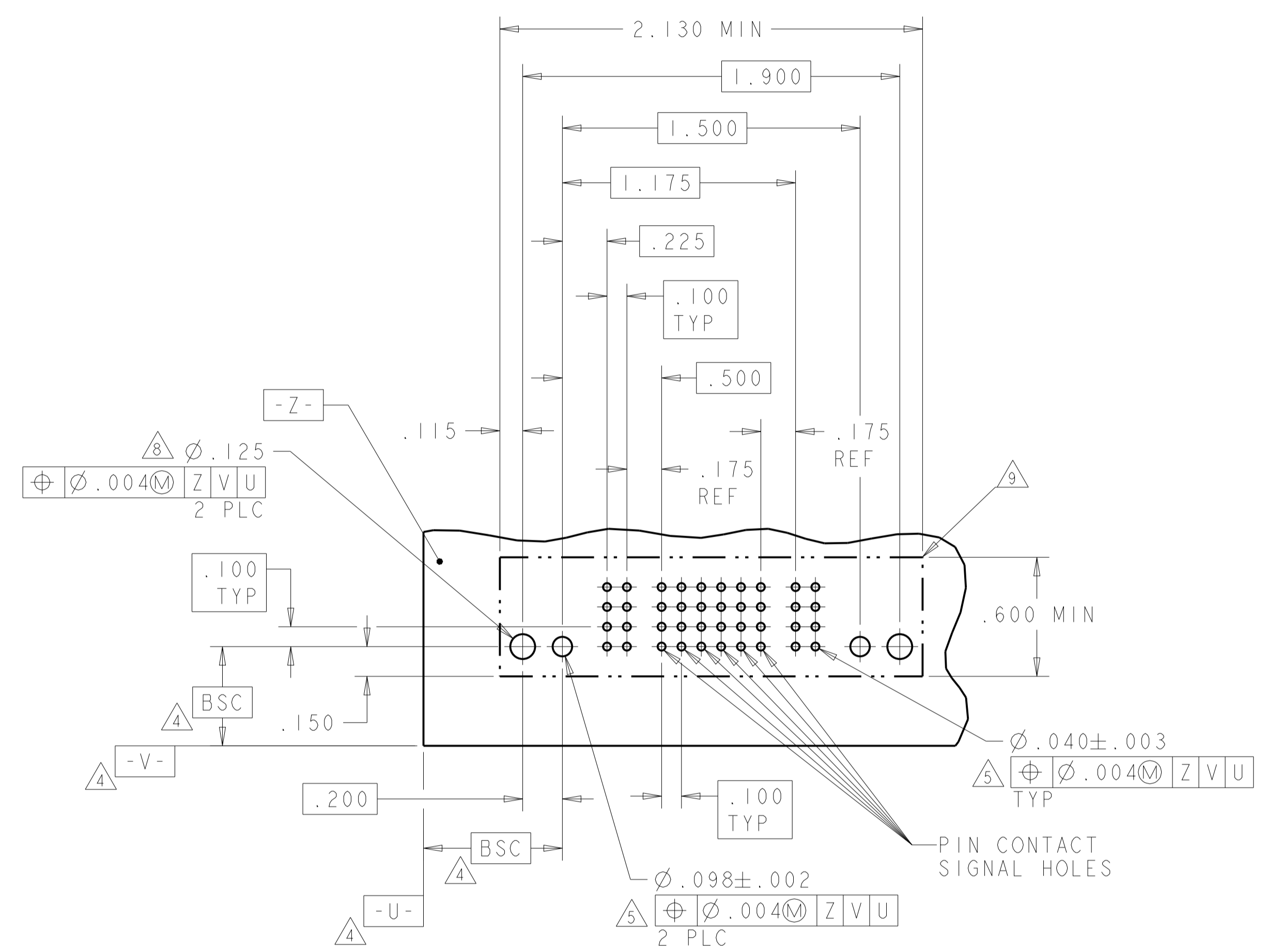

RECOMMENDED PCB LAYOUT 6600380-2
 SCALE 2:1

MATING SEQUENCE	DESCRIPTION	IDENTIFIER
-	RETENTION CLIP	HD
STANDARD	SIGNAL CONTACT	SV
-	POWER CONTACT	SZ

THIS DRAWING IS A CONTROLLED DOCUMENT.		OWN: J. McCLINTON 22MAR2005	TE Connectivity				
DIMENSIONS: INCH		CHK: D. TROUT 22MAR2005					
TOLERANCES UNLESS OTHERWISE SPECIFIED:		APPV: P. MLYNE 22MAR2005					
0 PLC ±	1 PLC ±	2 PLC ±	3 PLC ±	4 PLC ±	ANGLES ±	FINISH	NAME: VERTICAL HEADER ASSEMBLY, W/LATCH RECEIVER, SOLDERTAIL, TYPE PSP, MULTI-BEAM XL PRODUCT SPEC: 108-1973 APPLICATION SPEC: 114-13038 WEIGHT: A100779C=6600380 SCALE: 3:1 SHEET 2 OF 4 REV A5

LOC		DIST		REVISIONS			
NO	DATE	BY	CHK	DESCRIPTION	DATE	OWN	APVD
-	-	-	-	SEE SHEET 1	-	-	-

PART NUMBER	ROWS	POWER		SIGNAL						POWER	
		P1	P2	1	2	3	4	5	6	P3	P4
6600380-3	D	SZ	SZ	SV	SV	SV	SV	SV	SV	SZ	SZ
	C			SV	SV	SV	SV	SV	SV		
	B			SV	SV	SV	SV	SV	SV		
	A			SV	SV	SV	SV	SV	SV		
2P + 24S + 2P		HD								HD	

PART NUMBER	ROWS	POWER		SIGNAL						POWER	
		P1	P2	1	2	3	4	5	6	P3	P4
6600380-4	D	SZ	SZ	SV	SV	SV	SV	SV	SV	SZ	SZ
	C			SV	SV	SV	SV	SV	SV		
	B			SV	SV	SV	SV	SV	SV		
	A			SV	SV	SV	SV	SV	SV		
2ACP+24S+2ACP		HD								HD	

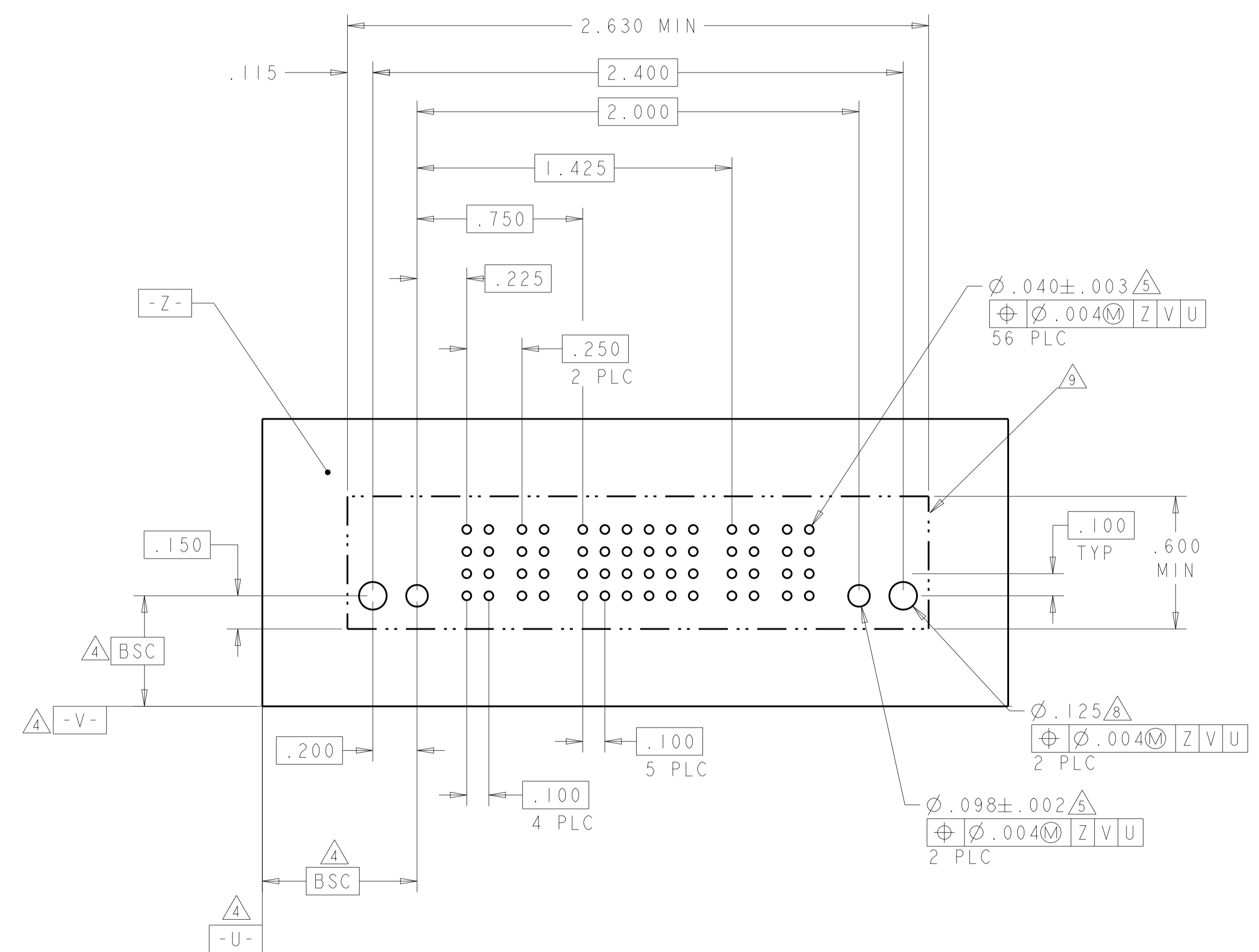

RECOMMENDED PCB LAYOUT 6600380-2
 SCALE 5:2

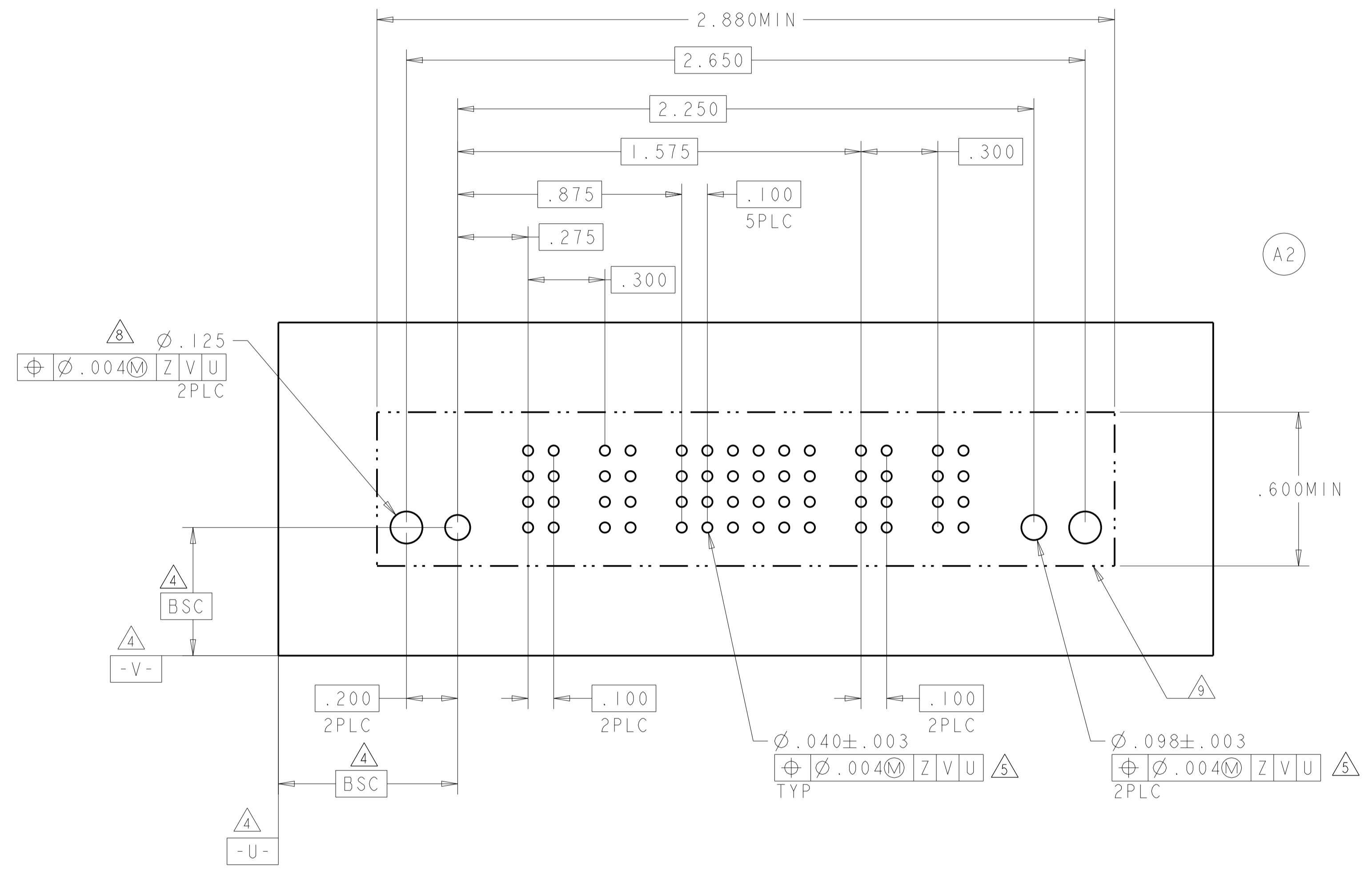



RECOMMENDED PCB LAYOUT 6600380-4

THIS DRAWING IS A CONTROLLED DOCUMENT.		OWN J. McCLINTON 22MAR2005	TE Connectivity
DIMENSIONS: INCH		CHK D. TROUT 22MAR2005	
TOLERANCES UNLESS OTHERWISE SPECIFIED:		APVD P. WHYNE 22MAR2005	NAME VERTICAL HEADER ASSEMBLY, W/LATCH RECEIVER, SOLDERTAIL, TYPE PSP, MULTI-BEAM XL
0 PLC ± 1 PLC ± 2 PLC ± 3 PLC ±0.005 4 PLC ± ANGLES ±		PRODUCT SPEC 108-1973	SIZE 114-13038
MATERIAL		APPLICATION SPEC	RESTRICTED TO
FINISH		WEIGHT	Customer Drawing
		SCALE 3:1	SHEET 3 OF 4
		DRAWING NO. A100779	REV A5
		C=6600380	

LOC		DIST		REVISIONS			
P	LTN	DESCRIPTION	DATE	DMN	APVD		
-	-	SEE SHEET 1	-	-	-		

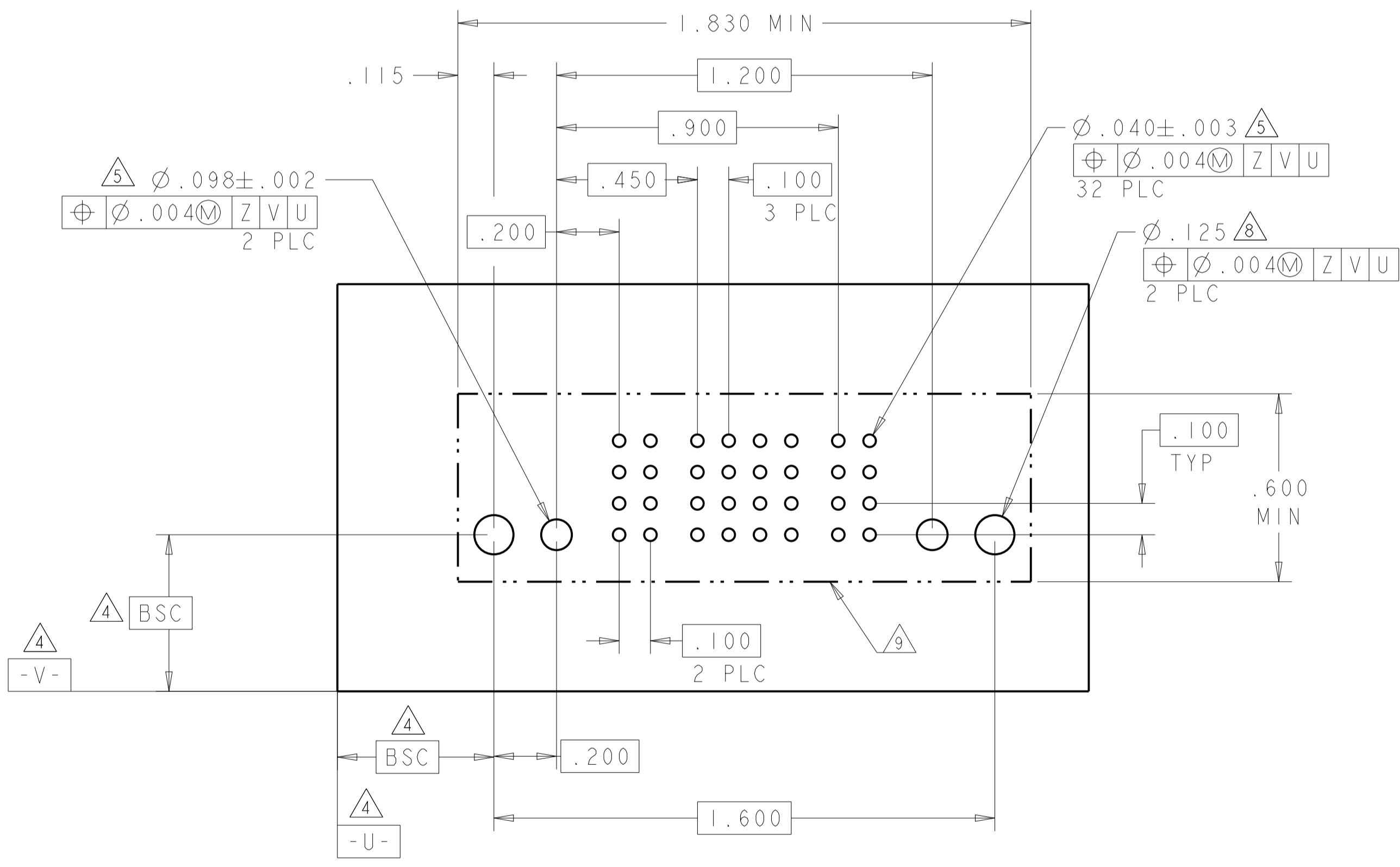
PART NUMBER	ROWS	POWER		SIGNAL				POWER	
		P1		1	2	3	4	P2	
6600380-5	D	SZ	SZ	SV	SV	SV	SV	SZ	SZ
	C			SV	SV	SV	SV		
	B			SV	SV	SV	SV		
	A			SV	SV	SV	SV		
IP+16S+IP		HD							HD



THIS DRAWING IS A CONTROLLED DOCUMENT.		DMN J. McCLINTON 22MAR2005	 TE Connectivity
DIMENSIONS: INCH		CHK D. TROUT 22MAR2005	
TOLERANCES UNLESS OTHERWISE SPECIFIED:		APVD B. WHYNE 22MAR2005	NAME VERTICAL HEADER ASSEMBLY, W/LATCH RECEIVER, SOLDERTAIL, TYPE PSP, MULTI-BEAM XL
0 PLC ± 1 PLC ± 2 PLC ± 3 PLC ±0.005 4 PLC ± ANGLES ±	± ± ± ± ±	PRODUCT SPEC 108-1973 APPLICATION SPEC 114-13038 WEIGHT -	SIZE CAGE CODE DRAWING NO A100779C=6600380 RESTRICTED TO -
MATERIAL -	FINISH -	Customer Drawing	SCALE 3:1 SHEET 4 OF 4 REV A5