

## 48 x 48 Digital LCD Timer 815E Part number 88857311



### Relay output digital timers

- LCD or LED (815E)
- Multi-range
- Multi-voltage
- 1 or 2 relay outputs
- Reset function on panel (Timers 815, 815E)
- Data saved in the event of a break in supply (Timer 815, 815E)
- Access to programming lockable (Timer 814, 815 and 815E)
- Up or down timing mode
- Internal power supply by battery (10 years / 20 °C) (Not 815E)

### Part numbers

	Type	Functions	Connections	Relay outputs	Supply voltage	Nominal rating
88857311	Timer 815E	A1, A1C, A2, A2C, AM, AMT, B, BM, C, CM, D, Di, DiM, Dpause, H, HM, T, TM, W, WM	11-pin plug-in	2 double timed changeover	12-24 V AC/ DC100 →240 V AC	2 x 5 A

### Specifications

Number of digits	4
Height of digits	TIMER 812 - 814 - 815 : 8 mm TIMER 815E : 7mm
Timing ranges	99,99 s 999,9 s 9999 s 99 min 59 s 99,99 min 999,9 min 9999 min 99 h 59 min 99,99 h 999,9 h 9999 h ( ? 815E)
Repetition accuracy (with constant parameters)	TIMER 812 - 814 - 815 : $\pm 0,03 \% \pm 20$ ms TIMER 815E : $\pm 0,01$ %
Display precision	TIMER 812 - 814 - 815 : $\pm 0,03 \% \pm 20$ ms TIMER 815E : $\pm 0,01$ %
Min. control pulse	50 ms
Maximum reset time by de-energisation during timed delay	50 ms
Maximum reset time by de-energisation after timing	50 ms
Nominal rating	TIMER 814 - 815 : 8 A AC 8 A DC TIMER 812 : 5 A AC 5 A DC TIMER 815E : 5 A - 250 V AC
Max. breaking voltage	TIMER 812 - 814 - 815 : 250 V AC 30 V DC TIMER 815E : 250 V AC 20 V DC
Maximum power rating (resistive)	TIMER 814 - 815 : 2000 VA - 190 W TIMER 812 : 1250 VA - 120 W TIMER 815E : 1500 VA - 100 W
Maximum admissible current	15 A < 0,01 s
Minimum current	TIMER 812 - 814 - 815 : 250 V AC 30 V DC 100 mA TIMER 815E : 500 mW (10 V / 5 mA)
Electrical life at I max., 250 V AC resistive (cycles)	$10^5$
Max. permitted number of operations at 1 max 250 V AC resistive per hour	600
Mechanical life (operations)	TIMER 812 - 814 - 815 : $5 \times 10^6$ TIMER 815E : $20 \times 10^6$
Voltage variation	TIMER 814 : + 10 % - 15 % TIMER 815E : + 10 % - 10 %
Immunity from micro power cuts	< 0,03 s
Max. absorbed power	0.5 W / 12 V 1 VA / 24 V 0.5 W / 24 V 3.5 VA / 110 V 1 W / 48 V 11 VA / 220 V TIMER 815E : Max. 3 W
Temperature limits use (°C)	TIMER 812 - 814 - 815 : -10 °C →+60 °C TIMER 815E : 0 °C →+60 °C
Temperature limits stored (°C)	TIMER 812 - 814 - 815 : -30 °C →+70 °C TIMER 815E : -30 °C →+80 °C
Degree of protection front face	TIMER 812 - 814 - 815 : IP65 TIMER 815E : IP30

Insulation according to standard IEC/EN 61812-1, IEC/EN 60255-5	EN61812-1 - IEC255-5
Protection class according to CEI/EN 60529	•
Mounting Front panel, by clip	•
Mounting base-mounted on socket	•
Material	Self-extinguishing UL 94 grade V0
Weight (g)	TIMER 814 : 100 TIMER 812 - 815 : 140 TIMER 815E : 120

### Accessories

Accessories	Code
8-pin solder-connected plug	25622301
11-pin connector base	25622080
11-pole rear base	79694002

### Dimensions (mm)

#### Timer 815E

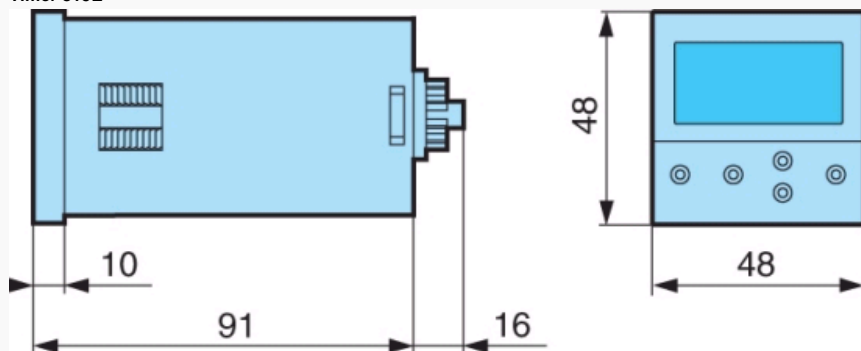

### Dimensions (mm)

#### Panel cut-out

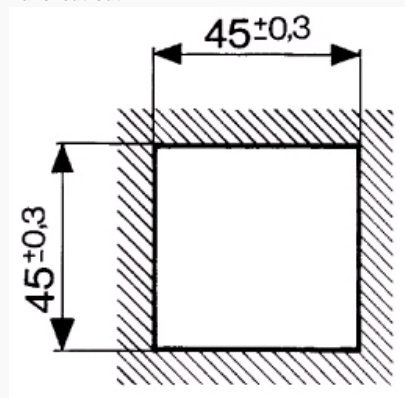

### Dimensions (mm)

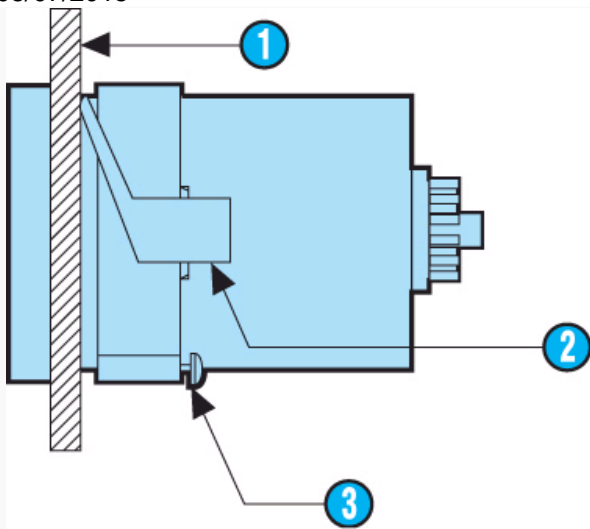

N°	Legend
1	Panel thickness 1 to 3,5 mm
2	Clip for panel-mounting
3	Positioning screw

**Dimensions (mm)**

11-pole rear base  
79694002  
Panel-mounted

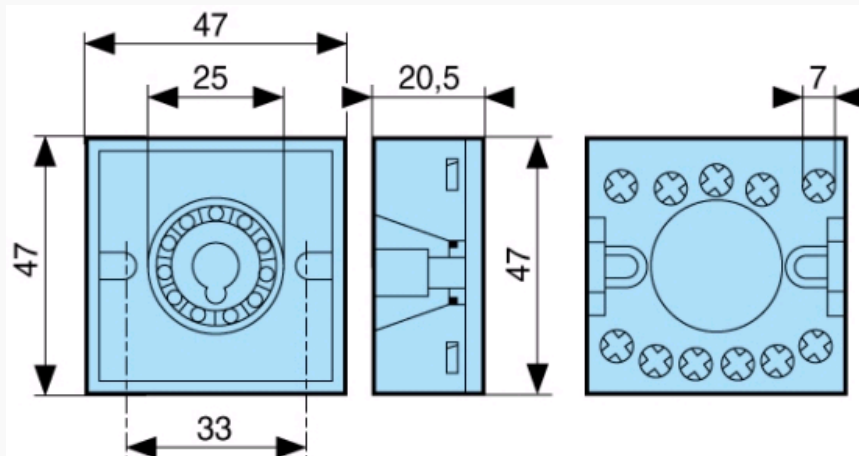

**Dimensions (mm)**

8-pin or 11-pin solder-connected plug  
25622301 - 25622076

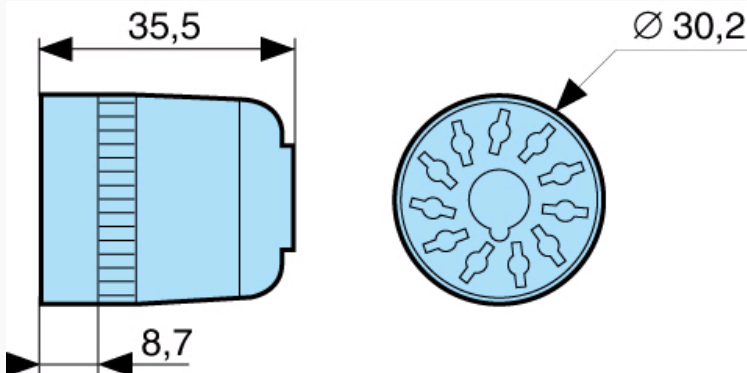

**Dimensions (mm)**

Connector socket  
11-pin 25622080

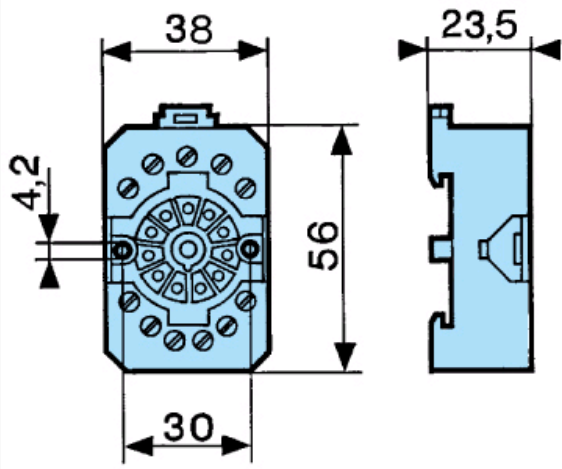

**Curves**

**815E - Function A1**

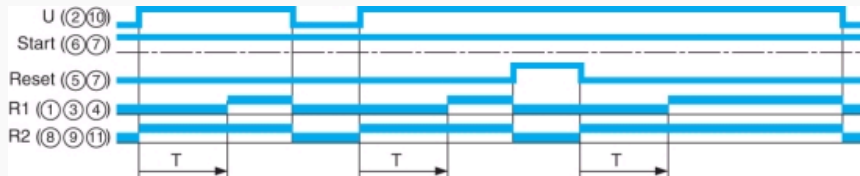

**Function A1**

Delay on energisation  
1 timed relay  
1 instantaneous relay

**Curves**

**815E - Function A1c**

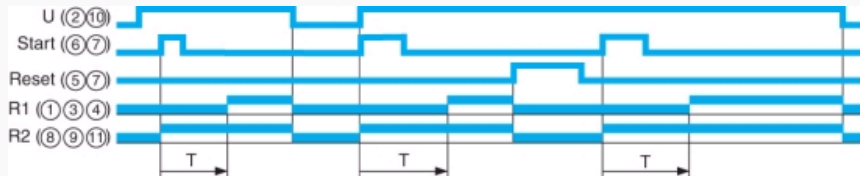

**Function A1c**

Delay on energisation  
1 timed relay  
1 instantaneous relay

**Curves**

**815E - Function A2**

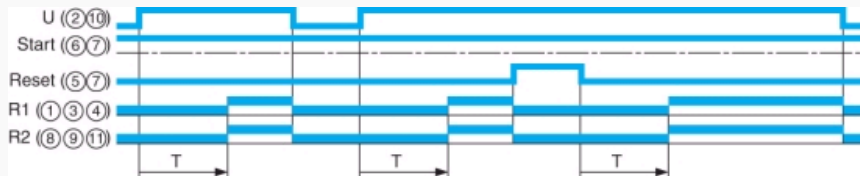

**Function A2**

Delay on energisation  
2 timed relays

**Curves**

**815E - Function A2c**

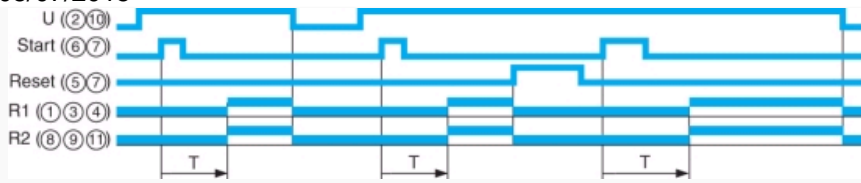

**Function A2c**

Delay on energisation  
2 timed relays

**Curves**

**815E - Function AM**

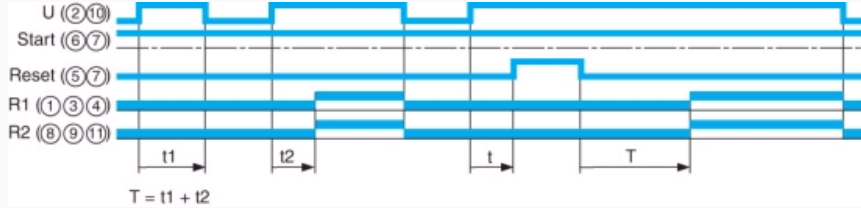

**Function AM**

Delay on energisation  
Memory during timing. Reset

**Curves**

**815E - Function AMt**

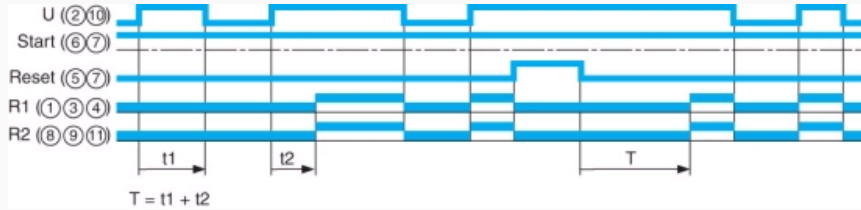

**Function AMt**

Delay on energisation  
Memory during and after timing. Reset

**Curves**

**815E - Function B**

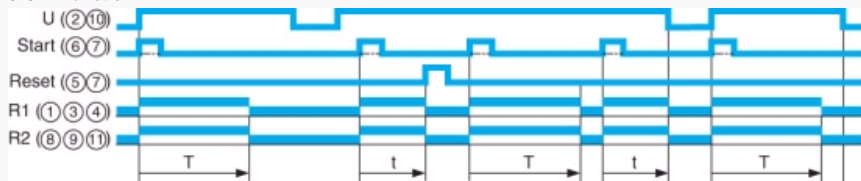

**Function B**

Timing on impulse one shot  
2 timed relays

**Curves**

**815E - Function B with memory**

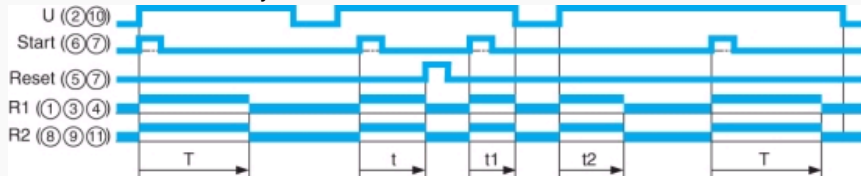

**Function B**

Timing on impulse one shot

**Curves**

**815E - Function C**

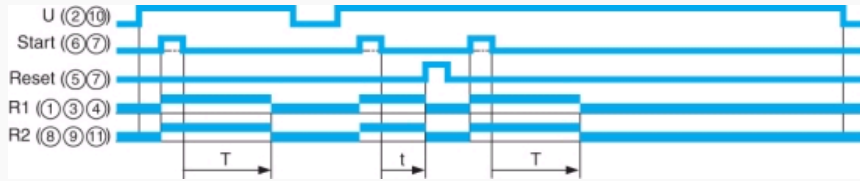

**Function C**

Timing after impulse (re-opening of control contact)

**Curves**

**815E - Function C with memory**

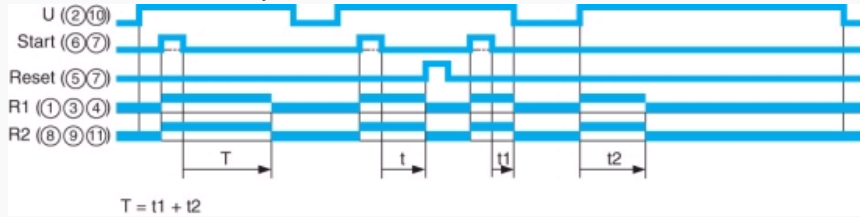

**Function C**

Timing after impulse (re-opening of control contact)

**Curves**

**815E - Function D**

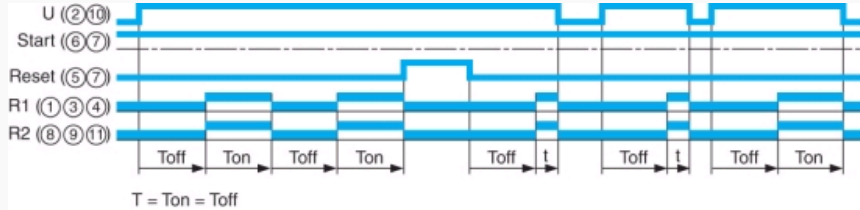

**Function D**

Flip-flop

**Curves**

**815E - Function Di**

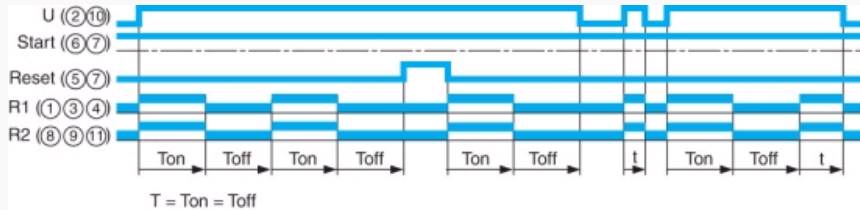

**Function Di**

Flip-flop

**Curves**

**815E - Function Di with memory**

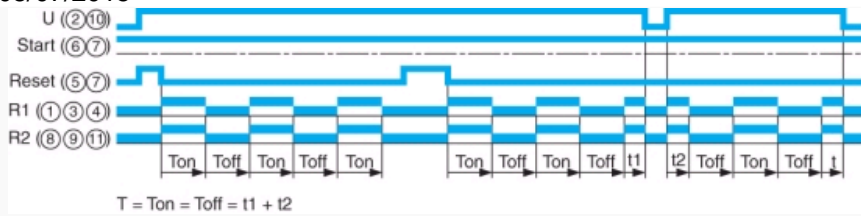

<b>Function Di</b>
Flip-flop

**Curves**

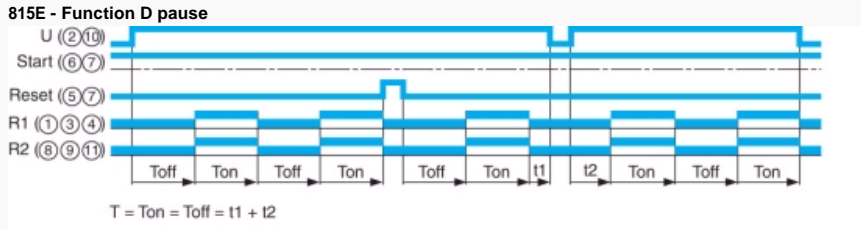

<b>Function D</b>
Flip-flop

**Curves**

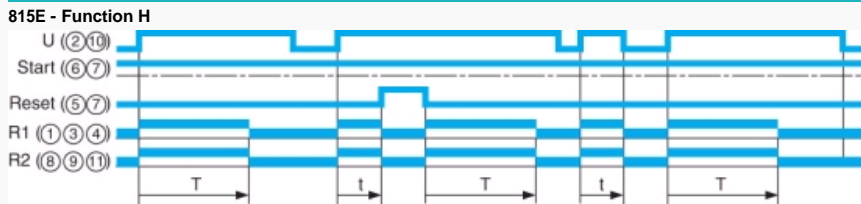

<b>Function H</b>
Timing on energisation, 2 timed relays

**Curves**

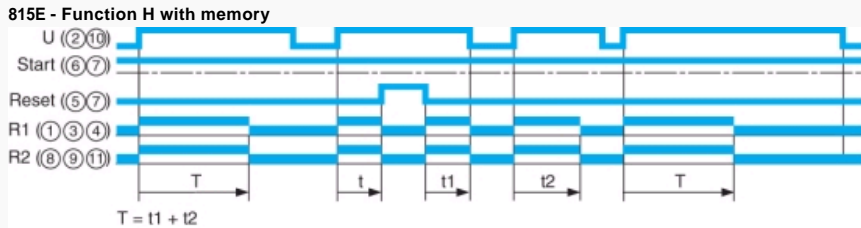

<b>Function H</b>
Timing on energisation, 2 timed relays

**Curves**

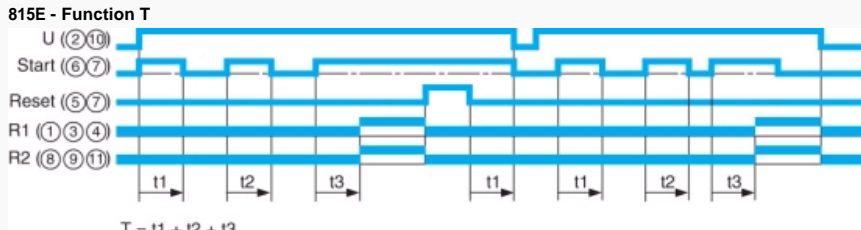

**Function T**

Timing on energisation by control signal (sum of times)

**Curves**

**815E - Function T with memory**

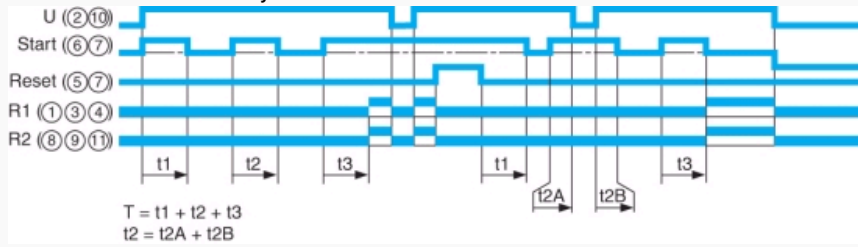

**Function T**

Timing on energisation by control signal (sum of times)

**Curves**

**815E - Function W**

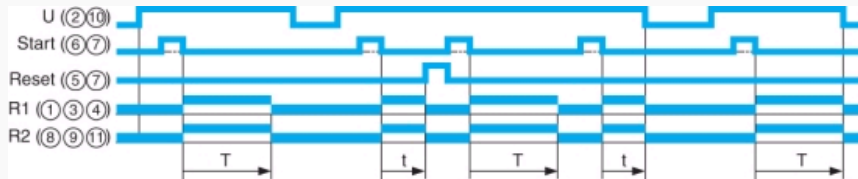

**Function W**

Timing after pulse on control contact, 2 timed relays

**Curves**

**815E - Function W with memory**

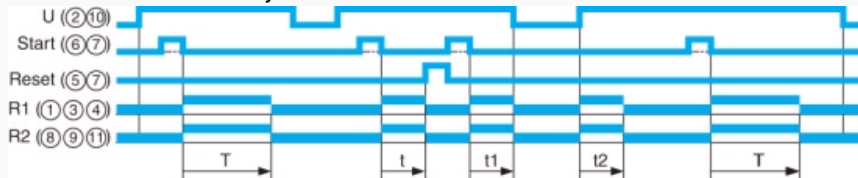

**Function W**

Timing after pulse on control contact, 2 timed relays

**Connections**

**Timer 815E - 11-pin**

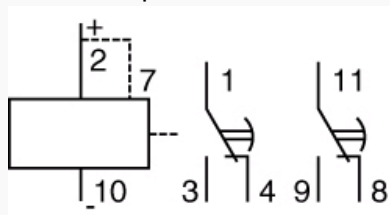

N°	Legend
	Supply
	Bridge (88 857 301-88 857 302-88 857 307)



1-3-4	Timed output contact
	Timed or instantaneous output contact

**Connections**

Timer 815E - 11-pin

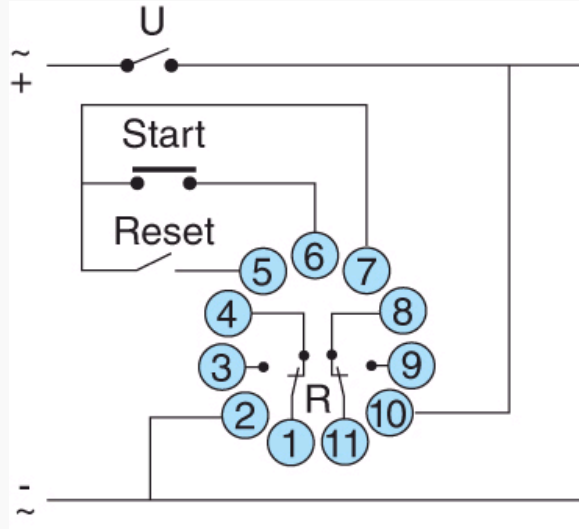

N°	Legend
①	Connect 6-7 after programming Function : A1-A2-AM-AMt-D-Di-H

**Connections**

Timer 815E - 11-pin

