

SECTION Z-Z

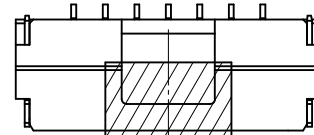

カプトンテープ付き
WITH KAPTON TAPE

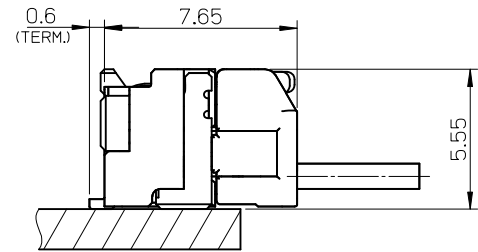
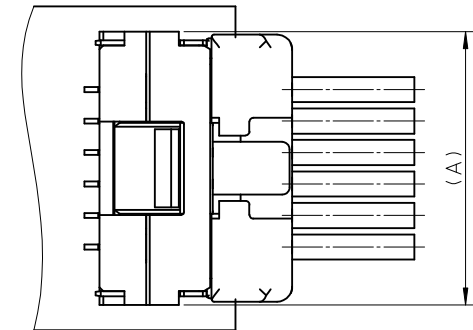

嵌合図

MATED CONNECTORS

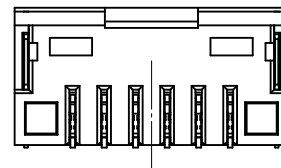
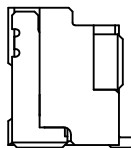
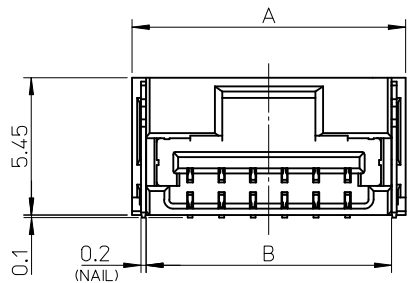

NOTES

1. 嵌合相手: 502380-****
MATE WITH : 502380-****
2. 端子テール部 及び ネイルの平坦度: 0.1MAX.
TAIL AND NAIL COPLANARITY TO BE 0.1 MAX.
3. 極数/2=偶数に適用.
APPLY FOR CKT. SIZE / 2 = EVEN.
4. 端子テール部 及び ネイルに錫めっきを使用しているため、
外観に摺動痕が付く場合が御座います。
THE WOUND OF FRICTION MIGHT ADHERE TO EXTERNALS
BECAUSE THE TIN PLATING IS USED FOR THA TAIL AND NAIL.
5. 本製品のプラスチック部に黒点等が確認される場合や
色合いが異なる場合がありますが、製品性能に影響はありません。
THERE IS NO INFLUENCE IN THE PRODUCT PERFORMANCE THOUGH
THE BLACK SPOT ETC. MIGHT BE CONFIRMED TO THE PLASTIC PART
OF THIS PRODUCT AND THE SHADE MIGHT BE DIFFERENT.
6. ELV 及び RoHS 適合品
ELV AND RoHS COMPLIANT

3.4	7.5	11	12.1	502386-07**	7
3.4	6.25	9.75	10.85	502386-06**	6
3.4	5	8.5	9.6	502386-05**	5
3.4	3.75	7.25	8.35	502386-04**	4
2.6	2.5	6	7.1	502386-03**	3
2.2	1.25	4.75	5.85	502386-02**	2
D	C	B	A	EMBOSSED TAPE PACKAGE オーダー番号 ORDER No.	極数 CKT. NO.

番号 NO.	部品 PART	材質 MATERIAL
①	ハウジング HOUSING	耐熱性樹脂 UL94V-0 色:SHEET 3 参照 HEATPROOF RESIN UL94V-0 COLOR : SEE SHEET 3
②	ターミナル TERMINAL	銅合金 COPPER ALLOY 錫めっき : 1.0 micro-meter MIN. TIN (TAIL AREA) ニッケルめっき(下地): 1.0 micro-meter MIN. NICKEL (UNDER PLATING)
③	ネイル NAIL	銅合金 COPPER ALLOY 錫めっき: 1.0 micro-meter MIN. TIN ニッケルめっき(下地): 1.0 micro-meter MIN. NICKEL (UNDER PLATING)

REVISED EC NO.: J2013-0870 DRWN: KWASHIO 2013/02/07 CHKD: KASAKAWA 2013/02/13 APPR: YO ITO 2013/02/13	DESCRIPTION REV	GENERAL TOLERANCES (UNLESS SPECIFIED)		DIMENSION STYLE MM ONLY		SCALE 5:1	DESIGN UNITS METRIC	THIRD ANGLE PROJECTION	
		10 UNDER	±0.2	DRAWN BY T. MIYAZAKI	DATE 2006/08/28	TITLE 1.25 W/B CONN. SINGLE R/A REC. ASS'Y 2-7CKT.			
		10 OVER 30 UNDER	±0.25	CHECKED BY K. ASAKAWA	DATE 2006/08/28				
		30 OVER	±0.3	APPROVED BY YO. ITO	DATE 2006/08/28				
ANGULAR ±3 °		DRAFT WHERE APPLICABLE MUST REMAIN WITHIN DIMENSIONS		MATERIAL NO. SEE TABLE		DOCUMENT NO. SD-502386-001		SHEET NO. 1 OF 3	
THIS DRAWING CONTAINS INFORMATION THAT IS PROPRIETARY TO MOLEX INCORPORATED AND SHOULD NOT BE USED WITHOUT WRITTEN PERMISSION									



2 CKT.

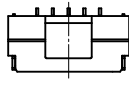

5 CKT.



3 CKT.

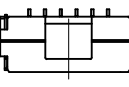

6 CKT.

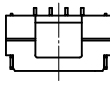

4 CKT.

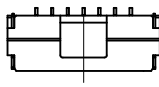

7 CKT.

極数の種類

KIND OF CKT. NO.(FRONT VIEW)

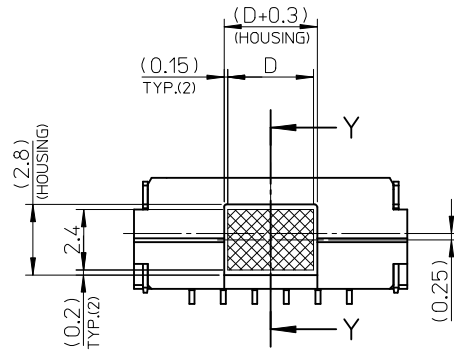

吸着範囲
VACUME AREA

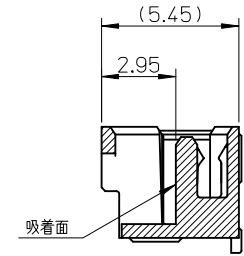

SECTION Y-Y

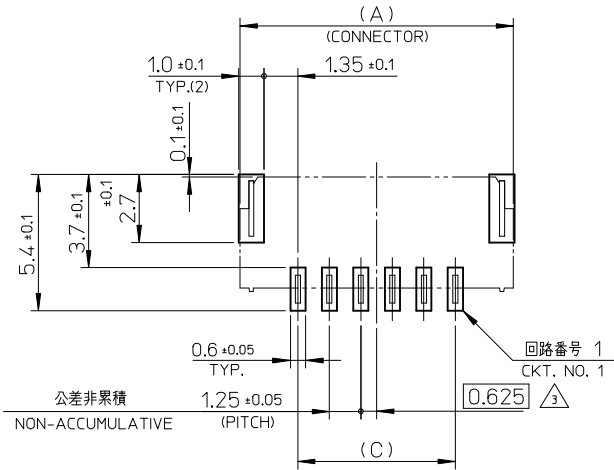

公差非累積
NON-ACCUMULATIVE

基板パターンレイアウト (参考)

RECCOMENDED P.C.B. PATTERN LAYOUT (REF.)

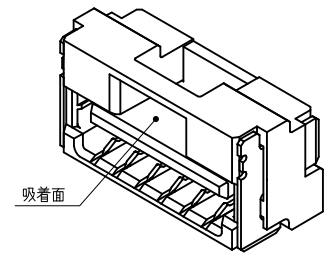

REVISED EC NO: J2013-0870 DRWN: KWASHIO 2013/02/07 CHKD: KASAKAWA 2013/02/13 APPR: Y01 ITO 2013/02/13	GENERAL TOLERANCES (UNLESS SPECIFIED)		DIMENSION STYLE MM ONLY	SCALE 5:1	DESIGN UNITS METRIC	THIRD ANGLE PROJECTION
	10 UNDER	±0.2	DRAWN BY T. MIYAZAKI	DATE 2006/08/28	TITLE 1.25 W/B CONN. SINGLE R/A REC. ASS'Y 2-7CKT.	
	10 OVER 30 UNDER	±0.25	CHECKED BY K. ASAKAWA	DATE 2006/08/28	molex DOCUMENT NO. SD-502386-001 SHEET NO. 2 OF 3	
	30 OVER	±0.3	APPROVED BY Y01 ITO	DATE 2006/08/28		
ANGULAR ±3 °		MATERIAL NO. SEE TABLE		THIS DRAWING CONTAINS INFORMATION THAT IS PROPRIETARY TO MOLEX INCORPORATED AND SHOULD NOT BE USED WITHOUT WRITTEN PERMISSION		
DRAFT WHERE APPLICABLE MUST REMAIN WITHIN DIMENSIONS		SIZE A3				

WITH CAPTON TAPE										
HSG COLOR : GREEN		HSG COLOR : BLUE		HSG COLOR : RED		HSG COLOR : BLACK		HSG COLOR : NATURAL		
502386-0736	502386-**16	502386-0734	502386-**14	502386-0732	502386-**12	502386-0731	502386-**11	502386-0772	502386-**08	7
502386-0636		502386-0634		502386-0632		502386-0631		502386-0672		6
502386-0536		502386-0534		502386-0532		502386-0531		502386-0572		5
502386-0436		502386-0434		502386-0432		502386-0431		502386-0472		4
502386-0336		502386-0334		502386-0332		502386-0331		502386-0372		3
502386-0236		502386-0234		502386-0232		502386-0231		502386-0272		2
EMBOSSSED TAPE PACKAGE オーダー番号ORDER No.	コネクタ シリズ CONNECTOR SIRIES	EMBOSSSED TAPE PACKAGE オーダー番号ORDER No.	コネクタ シリズ CONNECTOR SIRIES	EMBOSSSED TAPE PACKAGE オーダー番号ORDER No.	コネクタ シリズ CONNECTOR SIRIES	EMBOSSSED TAPE PACKAGE オーダー番号ORDER No.	コネクタ シリズ CONNECTOR SIRIES	EMBOSSSED TAPE PACKAGE オーダー番号ORDER No.	コネクタ シリズ CONNECTOR SIRIES	極数 (XT. NO.)

WITHOUT CAPTON TAPE										
HSG COLOR : GREEN		HSG COLOR : BLUE		HSG COLOR : RED		HSG COLOR : BLACK		HSG COLOR : NATURAL		
502386-0746	502386-**26	502386-0744	502386-**24	502386-0742	502386-**22	502386-0741	502386-**21	502386-0770	502386-**09	7
502386-0646		502386-0644		502386-0642		502386-0641		502386-0670		6
502386-0546		502386-0544		502386-0542		502386-0541		502386-0570		5
502386-0446		502386-0444		502386-0442		502386-0441		502386-0470		4
502386-0346		502386-0344		502386-0342		502386-0341		502386-0370		3
502386-0246		502386-0244		502386-0242		502386-0241		502386-0270		2
EMBOSSSED TAPE PACKAGE オーダー番号ORDER No.	コネクタ シリズ CONNECTOR SIRIES	EMBOSSSED TAPE PACKAGE オーダー番号ORDER No.	コネクタ シリズ CONNECTOR SIRIES	EMBOSSSED TAPE PACKAGE オーダー番号ORDER No.	コネクタ シリズ CONNECTOR SIRIES	EMBOSSSED TAPE PACKAGE オーダー番号ORDER No.	コネクタ シリズ CONNECTOR SIRIES	EMBOSSSED TAPE PACKAGE オーダー番号ORDER No.	コネクタ シリズ CONNECTOR SIRIES	極数 (XT. NO.)

REVISED EC NO.: J2013-0870 2013/02/07 DRWN:KAWASHIO 2013/02/13 CHKD:KASAKAWA 2013/02/13 APPR:Y0 ITO 2013/02/13	GENERAL TOLERANCES (UNLESS SPECIFIED)		DIMENSION STYLE MM ONLY		SCALE ----	DESIGN UNITS METRIC	THIRD ANGLE PROJECTION	
	10 UNDER	±0.2	DRAWN BY DATE T. MIYAZAKI 2006/08/28		TITLE 1.25 W/B CONN. SINGLE R/A REC. ASS'Y 2-7CKT.			
	10 OVER 30 UNDER	±0.25	CHECKED BY DATE K. ASAKAWA 2006/08/28					
	30 OVER	±0.3	APPROVED BY DATE Y0. ITO 2006/08/28					
	ANGULAR ±3 °		MATERIAL NO. SEE TABLE		DOCUMENT NO. SD-502386-001		SHEET NO. 3 OF 3	
DRAFT WHERE APPLICABLE MUST REMAIN WITHIN DIMENSIONS		SIZE A3 THIS DRAWING CONTAINS INFORMATION THAT IS PROPRIETARY TO MOLEX INCORPORATED AND SHOULD NOT BE USED WITHOUT WRITTEN PERMISSION						

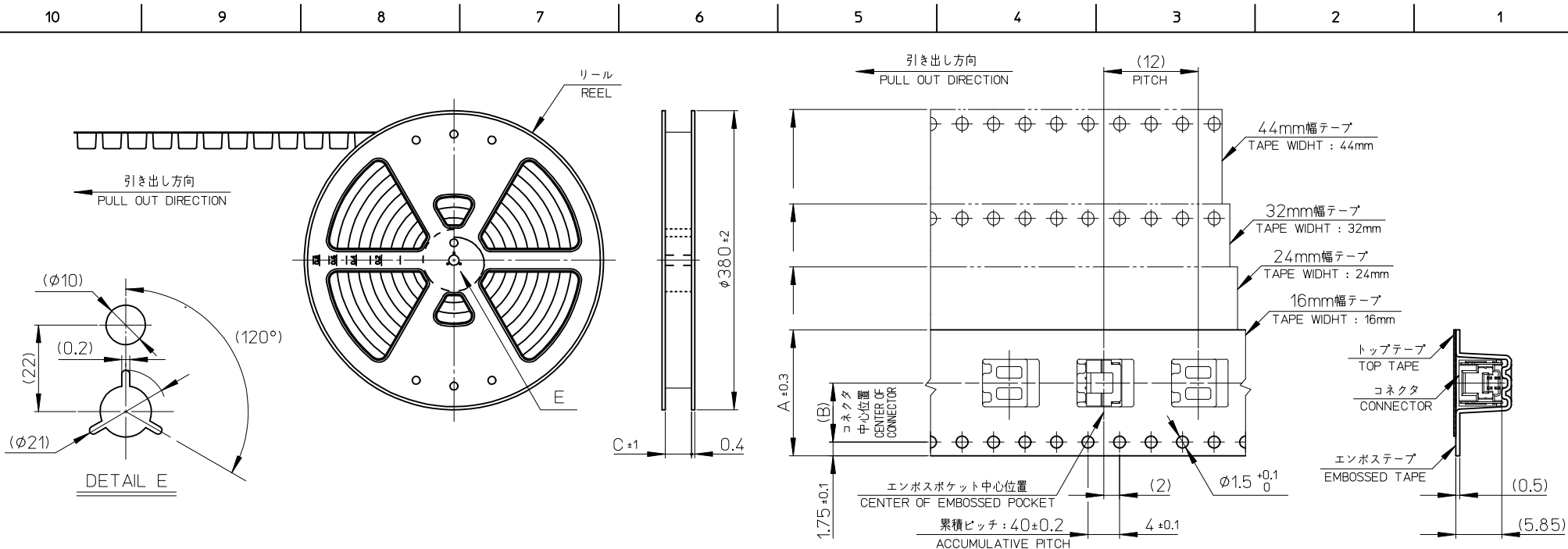

NOTES

- 製品詳細寸法については、SD-502386-001, -002 を参照下さい。
PLEASE REFER TO SD-502386-001, -002 FOR THE DETAILED DIMENSION OF THE CONNECTOR.
- 梱包数量 : 1200個
NUMBER OF CONNECTORS : 1200 PIECES/REEL.
- リードテープ長さ
LEAD TAPE LENGTH

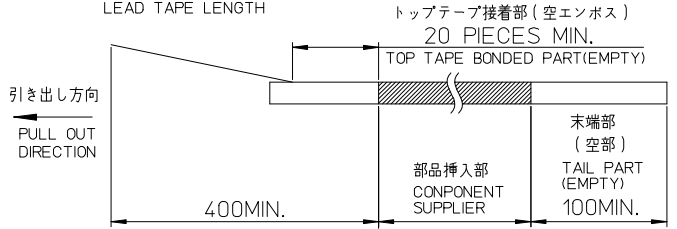

- 材料
MATERIAL
キャリアテープ : ポリスチレン
CARRIER TAPE : POLYSTYRENE
トップテープ : ポリエステル, ポリエチレン, ポリエチレンテレフタレート
TOP TAPE : POLYESTER, POLYETHYLENE, POLYETHYLENE TEREPHTHALATE
リール : ポリスチレン <リサイクル材を含む>
REEL : POLYSTYRENE <RECYCLE MATERIAL CONTAINED>
- ELV 及び RoHS 適合品
ELV AND RoHS COMPLIANT

45.5	20.2	44	502386-15**	15
45.5	20.2	44	502386-14**	14
33.5	14.2	32	502386-13**	13
33.5	14.2	32	502386-12**	12
33.5	14.2	32	502386-11**	11
33.5	14.2	32	502386-10**	10
25.5	11.5	24	502386-09**	9
25.5	11.5	24	502386-08**	8
25.5	11.5	24	502386-07**	7
25.5	11.5	24	502386-06**	6
25.5	11.5	24	502386-05**	5
25.5	11.5	24	502386-04**	4
17.5	7.5	16	502386-03**	3
17.5	7.5	16	502386-02**	2

REVISED EC NO.: J2013-0870 DRAWN: KWASHIO 2013/02/07 CHKD: KASAKAWA 2013/02/13 APPR: YO ITO 2013/02/13	DESCRIPTION	GENERAL TOLERANCES (UNLESS SPECIFIED)		DIMENSION STYLE MM ONLY		SCALE ---	DESIGN UNITS METRIC		THIRD ANGLE PROJECTION	
		10 UNDER	±0.2	DRAWN BY T. MIYAZAKI	DATE 2006/10/16	TITLE 1.25 W/B CONN. SINGLE R/A REC. EMBTP PKG				
		10 OVER 30 UNDER	±0.25	CHECKED BY K. ASAKAWA	DATE 2006/10/16					
		30 OVER	±0.3	APPROVED BY YO. ITO	DATE 2006/10/16					
REV	ANGULAR ±3 °	DRAFT WHERE APPLICABLE MUST REMAIN WITHIN DIMENSIONS		MATERIAL NO. SEE TABLE		DOCUMENT NO. SD-502386-003		SHEET NO. 1 OF 2		
SIZE A3 THIS DRAWING CONTAINS INFORMATION THAT IS PROPRIETARY TO MOLEX INCORPORATED AND SHOULD NOT BE USED WITHOUT WRITTEN PERMISSION										

F

WITHOUT CAPTON TAPE		
HSG COLOR : ORANGE		
502386-**28	--//	15
	--//	14
	--//	13
	--//	12
	--//	11
	--//	10
	502386-0948	9
	--//	8
	--//	7
	--//	6
--//	5	
--//	4	
--//	3	
--//	2	
コネクタ シリーズ CONNECTOR SERIES	製品番号 MATERIAL NO.	極数 (KT. NO.)

WITH CAPTON TAPE														
HSG COLOR : GREEN			HSG COLOR : BLUE			HSG COLOR : RED			HSG COLOR : BLACK			HSG COLOR : NATURAL		
--//	--//	--//	--//	--//	--//	--//	--//	--//	--//	--//	--//	--//	15	
--//	--//	--//	--//	--//	--//	--//	--//	--//	--//	--//	--//	--//	14	
--//	--//	--//	--//	--//	--//	--//	--//	--//	--//	--//	--//	--//	13	
--//	--//	--//	--//	--//	--//	--//	--//	--//	--//	--//	--//	--//	12	
--//	--//	--//	--//	--//	--//	--//	--//	--//	--//	--//	--//	--//	11	
--//	--//	--//	--//	--//	--//	--//	--//	--//	--//	--//	--//	--//	10	
--//	--//	--//	--//	--//	--//	--//	--//	--//	--//	--//	--//	--//	9	
--//	--//	--//	--//	--//	--//	--//	--//	--//	--//	--//	--//	--//	8	
502386-**16	502386-0736	502386-**14	502386-0734	502386-**12	502386-0732	502386-**11	502386-0731	502386-**08	502386-0772	502386-**08	502386-0772	502386-**08	502386-0772	7
	502386-0636		502386-0634		502386-0632		502386-0631		502386-0672		502386-0672		6	
	502386-0536		502386-0534		502386-0532		502386-0531		502386-0572		502386-0572		5	
	502386-0436		502386-0434		502386-0432		502386-0431		502386-0472		502386-0472		4	
	502386-0336		502386-0334		502386-0332		502386-0331		502386-0372		502386-0372		3	
	502386-0236		502386-0234		502386-0232		502386-0231		502386-0272		502386-0272		2	
コネクタ シリーズ CONNECTOR SERIES	製品番号 MATERIAL NO.	コネクタ シリーズ CONNECTOR SERIES	製品番号 MATERIAL NO.	コネクタ シリーズ CONNECTOR SERIES	製品番号 MATERIAL NO.	コネクタ シリーズ CONNECTOR SERIES	製品番号 MATERIAL NO.	コネクタ シリーズ CONNECTOR SERIES	製品番号 MATERIAL NO.	コネクタ シリーズ CONNECTOR SERIES	製品番号 MATERIAL NO.	極数 (KT. NO.)		

E

D

C

B

A

WITHOUT CAPTON TAPE																
HSG COLOR : GREEN			HSG COLOR : BLUE			HSG COLOR : YELLOW			HSG COLOR : RED			HSG COLOR : BLACK			HSG COLOR : NATURAL	
502386-**26	502386-1546	502386-**24	502386-1544	502386-**23	--//	502386-**22	502386-1542	502386-**21	502386-1541	502386-**09	502386-1570	502386-**09	502386-1570	15		
	502386-1446		502386-1444		--//		502386-1442		502386-1441		502386-1470		502386-1470	14		
	502386-1346		502386-1344		--//		502386-1342		502386-1341		502386-1370		502386-1370	13		
	502386-1246		502386-1244		--//		502386-1242		502386-1241		502386-1270		502386-1270	12		
	502386-1146		502386-1144		--//		502386-1142		502386-1141		502386-1170		502386-1170	11		
	502386-1046		502386-1044		--//		502386-1042		502386-1041		502386-1070		502386-1070	10		
	502386-0946		502386-0944		502386-0943		502386-0942		502386-0941		502386-0970		502386-0970	9		
	502386-0846		502386-0844		--//		502386-0842		502386-0841		502386-0870		502386-0870	8		
	502386-0746		502386-0744		--//		502386-0742		502386-0741		502386-0770		502386-0770	7		
	502386-0646		502386-0644		--//		502386-0642		502386-0641		502386-0670		502386-0670	6		
	502386-0546		502386-0544		--//		502386-0542		502386-0541		502386-0570		502386-0570	5		
	502386-0446		502386-0444		--//		502386-0442		502386-0441		502386-0470		502386-0470	4		
	502386-0346		502386-0344		--//		502386-0342		502386-0341		502386-0370		502386-0370	3		
	502386-0246		502386-0244		--//		502386-0242		502386-0241		502386-0270		502386-0270	2		
コネクタ シリーズ CONNECTOR SERIES	製品番号 MATERIAL NO.	コネクタ シリーズ CONNECTOR SERIES	製品番号 MATERIAL NO.	コネクタ シリーズ CONNECTOR SERIES	製品番号 MATERIAL NO.	コネクタ シリーズ CONNECTOR SERIES	製品番号 MATERIAL NO.	コネクタ シリーズ CONNECTOR SERIES	製品番号 MATERIAL NO.	コネクタ シリーズ CONNECTOR SERIES	製品番号 MATERIAL NO.	極数 (KT. NO.)				

REVISED EC NO. J2013-0870 DRWN:KAWASHIO 2013/02/13 CHKD:KASAKAWA 2013/02/13 APPR:Y01TO 2013/02/13	GENERAL TOLERANCES (UNLESS SPECIFIED)		DIMENSION STYLE MM ONLY		SCALE ---	DESIGN UNITS METRIC	THIRD ANGLE PROJECTION
	10 UNDER	±0.2	DRAWN BY T. MIYAZAKI	DATE 2006/10/16	TITLE 1.25 W/B CONN. SINGLE R/A REC. EMBTP PKG		
	10 OVER 30 UNDER	±0.25	CHECKED BY K. ASAKAWA	DATE 2006/10/16	MATERIAL NO. SD-502386-003		
	30 OVER	±0.3	APPROVED BY Y01.I TO	DATE 2006/10/16	SHEET NO. 2 OF 2		
	ANGULAR ±3 ° DRAFT WHERE APPLICABLE MUST REMAIN WITHIN DIMENSIONS		SEE TABLE		THIS DRAWING CONTAINS INFORMATION THAT IS PROPRIETARY TO MOLEX INCORPORATED AND SHOULD NOT BE USED WITHOUT WRITTEN PERMISSION		

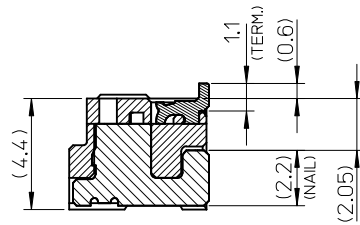
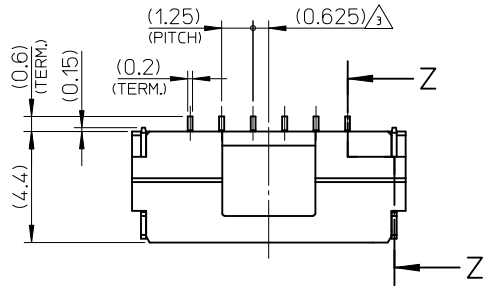

SECTION Z-Z

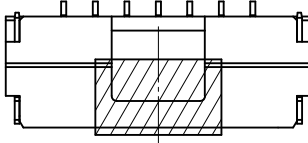

カプトンテープ付き
WITH KAPTON TAPE

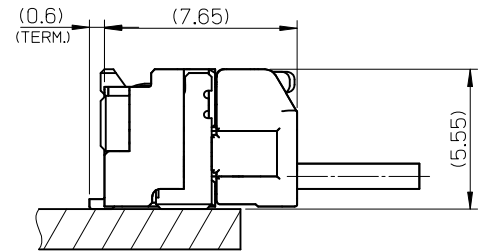
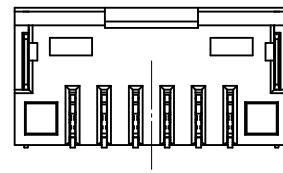
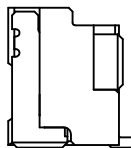
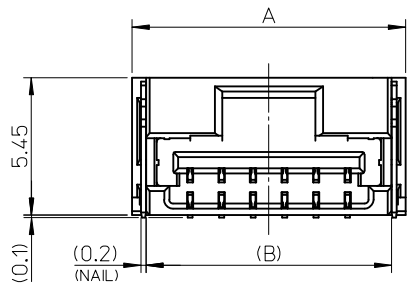
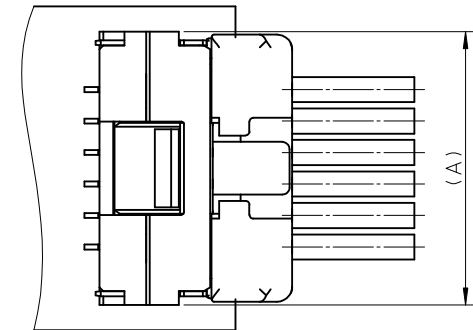

嵌合図

MATED CONNECTORS

NOTES

1. 嵌合相手: 502380-****
MATE WITH : 502380-****
2. 端子テール部 及び ネイルの平坦度: 0.1MAX.
TAIL AND NAIL COPLANARITY TO BE 0.1 MAX.
3. 極数/2=偶数に適用.
APPLY FOR CKT. SIZE / 2 = EVEN.
4. 端子テール部 及び ネイルに錫めっきを使用しているため、
外観に摺動痕が付く場合が御座います。
THE WOUND OF FRICTION MIGHT ADHERE TO EXTERNALS
BECAUSE THE TIN PLATING IS USED FOR THA TAIL AND NAIL.
5. 本製品のプラスチック部に黒点等が確認される場合や
色合いが異なる場合がありますが、製品性能に影響はありません。
THERE IS NO INFLUENCE IN THE PRODUCT PERFORMANCE THOUGH
THE BLACK SPOT ETC. MIGHT BE CONFIRMED TO THE PLASTIC PART
OF THIS PRODUCT AND THE SHADE MIGHT BE DIFFERENT.
6. ELV 及び RoHS 適合品
ELV AND RoHS COMPLIANT

3.4	7.5	11	12.1	502386-0707	7
3.4	6.25	9.75	10.85	502386-0607	6
3.4	5	8.5	9.6	502386-0507	5
3.4	3.75	7.25	8.35	502386-0407	4
2.6	2.5	6	7.1	502386-0307	3
2.2	1.25	4.75	5.85	502386-0207	2
D	C	B	A	EMBOSSED TAPE PACKAGE オーダー番号 ORDER No.	極数 CKT. NO.

番号 NO.	部品 PART	材質 MATERIAL
①	ハウジング HOUSING	耐熱性樹脂 UL94V-0 色: ナチュラル HEATPROOF RESIN UL94V-0 COLOR : NATURAL
②	ターミナル TERMINAL	銅合金 COPPER ALLOY 金めっき : 0.1 micro-meter MIN. GOLD ニッケルめっき(下地): 1.0 micro-meter MIN. NICKEL (UNDER PLATING)
③	ネイル NAIL	銅合金 COPPER ALLOY 錫めっき: 1.0 micro-meter MIN. TIN ニッケルめっき(下地): 1.0 micro-meter MIN. NICKEL (UNDER PLATING)

RELEASED EC NO.: J2016-0012 DRWN: TAKAIKE 2015/07/23 CHKD: KASAKAWA 2015/07/21 APPR: NUKITA 2015/07/21	DESCRIPTION REV	GENERAL TOLERANCES (UNLESS SPECIFIED)		DIMENSION STYLE MM ONLY		SCALE	DESIGN UNITS	TITLE 1.25 W/B CONN. SINGLE R/A REC. ASS'Y 2-7CKT.
		0.25 UNDER UNDER ±0.03		DRAWN BY DATE				
		0.25 OVER 0.5 UNDER ±0.05		TAKAIKE 2015/02/23				
		0.5 OVER 1.0 UNDER ±0.1		CHECKED BY DATE				
1.0 OVER 10 UNDER ±0.2		1.0 OVER 30 UNDER ±0.25		KASAKAWA 2015/07/21				THIRD ANGLE PROJECTION
30 OVER ±0.3		ANGULAR ±3 °		APPROVED BY DATE				
DRAFT WHERE APPLICABLE MUST REMAIN WITHIN DIMENSIONS		SIZE A3		MATERIAL NO.				
		SEE TABLE		NUKITA 2015/07/21				
				DOCUMENT NO.		SD-502386-006		SHEET NO. 1 OF 2
THIS DRAWING CONTAINS INFORMATION THAT IS PROPRIETARY TO MOLEX INCORPORATED AND SHOULD NOT BE USED WITHOUT WRITTEN PERMISSION								



2 CKT.



3 CKT.



4 CKT.

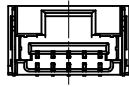
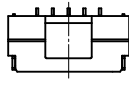

5 CKT.

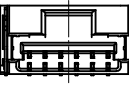
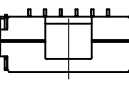

6 CKT.

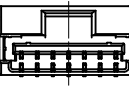
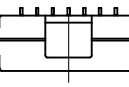

7 CKT.

極数の種類

KIND OF CKT. NO.(FRONT VIEW)

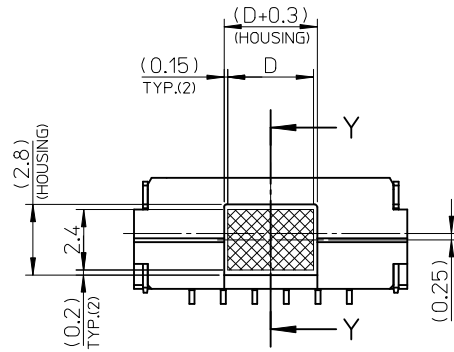

吸着範囲
VACUME AREA

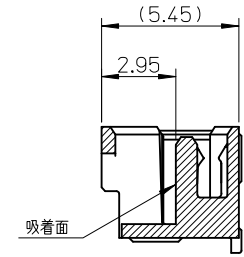

SECTION Y-Y

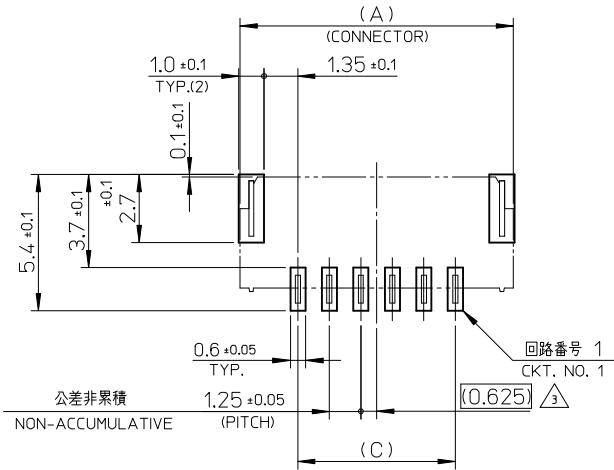

公差非累積
NON-ACCUMULATIVE

基板パターンレイアウト (参考)

RECCOMENDED P.C.B. PATTERN LAYOUT (REF.)

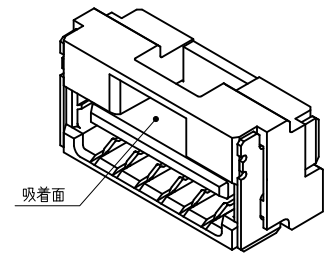

RELEASED EC NO: J2016-0012 DRWN:TAKAIKE 2015/02/23 CHKD:KASAKAWA 2015/07/21 APPR:NUKITA 2015/07/21	GENERAL TOLERANCES (UNLESS SPECIFIED)			DIMENSION STYLE MM ONLY		SCALE	DESIGN UNITS METRIC	THIRD ANGLE PROJECTION
	0.25 UNDER	UNDER	± 0.03	DRAWN BY	DATE	TITLE	1.25 W/B CONN. SINGLE R/A REC. ASS'Y 2-7CKT.	
	0.25 OVER	0.5 UNDER	± 0.05	TAKAIKE	2015/02/23			
	0.5 OVER	1.0 UNDER	± 0.1	CHECKED BY	DATE			
	1.0 OVER	10 UNDER	± 0.2	KASAKAWA	2015/07/21			
10 OVER	30 UNDER	± 0.25	APPROVED BY	DATE		DOCUMENT NO.	SHEET NO.	
30 OVER		± 0.3	NUKITA	2015/07/21		SD-502386-006	2 OF 2	
ANGULAR	± 3 °		MATERIAL NO.					
DRAFT WHERE APPLICABLE MUST REMAIN WITHIN DIMENSIONS			SEE TABLE		THIS DRAWING CONTAINS INFORMATION THAT IS PROPRIETARY TO MOLEX INCORPORATED AND SHOULD NOT BE USED WITHOUT WRITTEN PERMISSION			