



## Reference Specification

150°C Operation Leaded MLCC for Automotive with AEC-Q200  
RHE Series

Product specifications in this catalog are as of Dec. 2017, and are subject to change or obsolescence without notice.

Please consult the approval sheet before ordering. Please read rating and Cautions first.

## Reference only

### ⚠ CAUTION

#### 1. OPERATING VOLTAGE

When DC-rated capacitors are to be used in AC or ripple current circuits, be sure to maintain the  $V_{p-p}$  value of the applied voltage or the  $V_{o-p}$  which contains DC bias within the rated voltage range. When the voltage is started to apply to the circuit or it is stopped applying, the irregular voltage may be generated for a transit period because of resonance or switching. Be sure to use a capacitor within rated voltage containing these irregular voltage.

When DC-rated capacitors are to be used in input circuits from commercial power source (AC filter), be sure to use Safety Recognized Capacitors because various regulations on withstand voltage or impulse withstand established for each equipment should be taken into considerations.

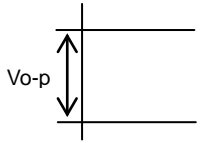
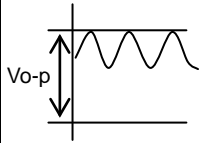
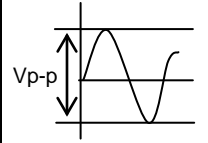
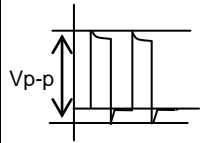
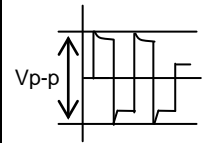
Voltage	DC Voltage	DC+AC Voltage	AC Voltage	Pulse Voltage(1)	Pulse Voltage(2)
Positional Measurement					

#### 2. OPERATING TEMPERATURE AND SELF-GENERATED HEAT

Keep the surface temperature of a capacitor below the upper limit of its rated operating temperature range. Be sure to take into account the heat generated by the capacitor itself.

When the capacitor is used in a high-frequency current, pulse current or the like, it may have the self-generated heat due to dielectric-loss. In case of Class 2 capacitors (Temp.Char. : X7R,X7S,X8L, etc.), applied voltage should be the load such as self-generated heat is within 20 °C on the condition of atmosphere temperature 25 °C. Please contact us if self-generated heat is occurred with Class 1 capacitors (Temp.Char. : C0G,U2J,X8G, etc.). When measuring, use a thermocouple of small thermal capacity-K of  $\phi 0.1\text{mm}$  and be in the condition where capacitor is not affected by radiant heat of other components and wind of surroundings. Excessive heat may lead to deterioration of the capacitor's characteristics and reliability.

#### 3. Fail-safe

Be sure to provide an appropriate fail-safe function on your product to prevent a second damage that may be caused by the abnormal function or the failure of our product.

#### 4. OPERATING AND STORAGE ENVIRONMENT

The insulating coating of capacitors does not form a perfect seal; therefore, do not use or store capacitors in a corrosive atmosphere, especially where chloride gas, sulfide gas, acid, alkali, salt or the like are present. And avoid exposure to moisture. Before cleaning, bonding, or molding this product, verify that these processes do not affect product quality by testing the performance of a cleaned, bonded or molded product in the intended equipment. Store the capacitors where the temperature and relative humidity do not exceed 5 to 40 °C and 20 to 70%. Use capacitors within 6 months.

#### 5. VIBRATION AND IMPACT

Do not expose a capacitor or its leads to excessive shock or vibration during use.

#### 6. SOLDERING

When soldering this product to a PCB/PWB, do not exceed the solder heat resistance specification of the capacitor. Subjecting this product to excessive heating could melt the internal junction solder and may result in thermal shocks that can crack the ceramic element.

#### 7. BONDING AND RESIN MOLDING, RESIN COAT

In case of bonding, molding or coating this product, verify that these processes do not affect the quality of capacitor by testing the performance of a bonded or molded product in the intended equipment.

In case of the amount of applications, dryness / hardening conditions of adhesives and molding resins containing organic solvents (ethyl acetate, methyl ethyl ketone, toluene, etc.) are unsuitable, the outer coating resin of a capacitor is damaged by the organic solvents and it may result, worst case, in a short circuit.

The variation in thickness of adhesive or molding resin may cause a outer coating resin cracking and/or ceramic element cracking of a capacitor in a temperature cycling.

#### 8. TREATMENT AFTER BONDING AND RESIN MOLDING, RESIN COAT

When the outer coating is hot (over 100 °C) after soldering, it becomes soft and fragile.

So please be careful not to give it mechanical stress.

## Reference only

Failure to follow the above cautions may result, worst case, in a short circuit and cause fuming or partial dispersion when the product is used.

### 9. LIMITATION OF APPLICATIONS

Please contact us before using our products for the applications listed below which require especially high reliability for the prevention of defects which might directly cause damage to the third party's life, body or property.

1. Aircraft equipment
2. Aerospace equipment
3. Undersea equipment
4. Power plant control equipment
5. Medical equipment
6. Transportation equipment (vehicles, trains, ships, etc.)
7. Traffic signal equipment
8. Disaster prevention / crime prevention equipment
9. Data-processing equipment exerting influence on public
10. Application of similar complexity and/or reliability requirements to the applications listed in the above.

### NOTICE

#### 1. CLEANING (ULTRASONIC CLEANING)

To perform ultrasonic cleaning, observe the following conditions.

Rinse bath capacity : Output of 20 watts per liter or less.

Rinsing time : 5 min maximum.

Do not vibrate the PCB/PWB directly.

Excessive ultrasonic cleaning may lead to fatigue destruction of the lead wires.

#### 2. Soldering and Mounting

Insertion of the Lead Wire

- When soldering, insert the lead wire into the PCB without mechanically stressing the lead wire.
- Insert the lead wire into the PCB with a distance appropriate to the lead space.

#### 3. CAPACITANCE CHANGE OF CAPACITORS

- Class 2 capacitors (Temp.Char. : X7R,X7S,X8L, etc.)

Class 2 capacitors an aging characteristic, whereby the capacitor continually decreases its capacitance slightly if the capacitor leaves for a long time. Moreover, capacitance might change greatly depending on a surrounding temperature or an applied voltage. So, it is not likely to be able to use for the time constant circuit.

Please contact us if you need a detail information.



### NOTE

1. Please make sure that your product has been evaluated in view of your specifications with our product being mounted to your product.
2. You are requested not to use our product deviating from this specification.

## Reference only

### 1. Application

This specification is applied to 150°C Operation Leaded MLCC RHE series in accordance with AEC-Q200 requirements used for Automotive Electronic equipment.

### 2. Rating

- Applied maximum temperature up to 150°C

Note : Maximum accumulative time to 150°C is within 2000 hours.

- Part number configuration

ex.)	RHE	L8	1H	103	K	0	A2	H03	B
	Series	Temperature Characteristic	Rated voltage	Capacitance	Capacitance tolerance	Dimension code	Lead code	Individual specification code	Packing style code

- Series

Code	Content
RHE	Epoxy coated, 150°C max.

- Temperature characteristic

Code	Temp. Char.	Temp. Range	Cap. Change (Within%)	Standard Temp.	Operating Temp. Range
L8	X8L	-55~+125°C	+/-15	25°C	-55~+150°C
		+125~+150°C	+15/-40		

- Rated voltage

Code	Rated voltage
1E	DC25V
1H	DC50V
2A	DC100V

- Capacitance

The first two digits denote significant figures ; the last digit denotes the multiplier of 10 in pF.  
ex.) In case of 103.

$$10 \times 10^3 = 10000 \text{pF}$$

- Capacitance tolerance

Code	Capacitance tolerance
K	+/-10%
M	+/-20%

- Dimension code

Code	Dimensions (LxW) mm max.
0	3.6 x 3.5
1	4.0 x 3.5
2	5.5 x 4.0
3	5.5 x 5.0
W	5.5 x 7.5

## Reference only

- Lead code

Code	Lead style	Lead spacing (mm)
A2	Straight type	2.5+/-0.8
DB	Straight taping type	2.5+0.4/-0.2
K1	Inside crimp type	5.0+/-0.8
M1	Inside crimp taping type	5.0+0.6/-0.2

Lead wire is solder coated CP wire.

- Individual specification code

Murata's control code

Please refer to [ Part number list ].

- Packing style code

Code	Packing style
A	Taping type of Ammo
B	Bulk type

### 3. Marking

Temp. char. : Letter code : 8 (X8L char.)

Capacitance : 3 digit numbers

Capacitance tolerance : Code







Rated voltage : Letter code : 2 (DC25V only, Except dimension code : 0,1)

Letter code : 5 (DC50V only, Except dimension code : 0,1)

Letter code : 1 (DC100V only, Except dimension code : 0,1)

Company name code : Abbreviation :  (Except dimension code : 0,1)

(Ex.)

Rated voltage Dimension code	25V	50V	100V
	0,1		
2			
3, W			—

Reference only

4. Part number list

• Straight Long  
(Lead Code:A2)

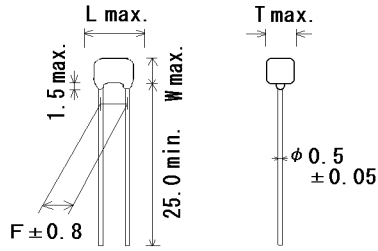

Unit : mm

Customer Part Number	Murata Part Number	T.C.	DC Rated Volt. (V)	Cap.	Cap. tol.	Dimension (mm)					Size Lead Code	Pack qty. (pcs)
						L	W	W1	F	T		
	RHEL81E104K0A2H03B	X8L	25	0.1μF	±10%	3.6	3.5	-	2.5	2.5	0A2	500
	RHEL81E154K0A2H03B	X8L	25	0.15μF	±10%	3.6	3.5	-	2.5	2.5	0A2	500
	RHEL81E224K0A2H03B	X8L	25	0.22μF	±10%	3.6	3.5	-	2.5	2.5	0A2	500
	RHEL81E334K1A2H03B	X8L	25	0.33μF	±10%	4.0	3.5	-	2.5	2.5	1A2	500
	RHEL81E474K1A2H03B	X8L	25	0.47μF	±10%	4.0	3.5	-	2.5	2.5	1A2	500
	RHEL81E684K1A2H03B	X8L	25	0.68μF	±10%	4.0	3.5	-	2.5	2.5	1A2	500
	RHEL81E105K1A2H03B	X8L	25	1.0μF	±10%	4.0	3.5	-	2.5	2.5	1A2	500
	RHEL81E155K2A2H03B	X8L	25	1.5μF	±10%	5.5	4.0	-	2.5	3.15	2A2	500
	RHEL81E225K2A2H03B	X8L	25	2.2μF	±10%	5.5	4.0	-	2.5	3.15	2A2	500
	RHEL81E335K2A2H03B	X8L	25	3.3μF	±10%	5.5	4.0	-	2.5	3.15	2A2	500
	RHEL81E475K2A2H03B	X8L	25	4.7μF	±10%	5.5	4.0	-	2.5	3.15	2A2	500
	RHEL81E106K3A2H03B	X8L	25	10μF	±10%	5.5	5.0	-	2.5	4.0	3A2	500
	RHEL81H221K0A2H03B	X8L	50	220pF	±10%	3.6	3.5	-	2.5	2.5	0A2	500
	RHEL81H331K0A2H03B	X8L	50	330pF	±10%	3.6	3.5	-	2.5	2.5	0A2	500
	RHEL81H471K0A2H03B	X8L	50	470pF	±10%	3.6	3.5	-	2.5	2.5	0A2	500
	RHEL81H681K0A2H03B	X8L	50	680pF	±10%	3.6	3.5	-	2.5	2.5	0A2	500
	RHEL81H102K0A2H03B	X8L	50	1000pF	±10%	3.6	3.5	-	2.5	2.5	0A2	500
	RHEL81H152K0A2H03B	X8L	50	1500pF	±10%	3.6	3.5	-	2.5	2.5	0A2	500
	RHEL81H222K0A2H03B	X8L	50	2200pF	±10%	3.6	3.5	-	2.5	2.5	0A2	500
	RHEL81H332K0A2H03B	X8L	50	3300pF	±10%	3.6	3.5	-	2.5	2.5	0A2	500
	RHEL81H472K0A2H03B	X8L	50	4700pF	±10%	3.6	3.5	-	2.5	2.5	0A2	500
	RHEL81H682K0A2H03B	X8L	50	6800pF	±10%	3.6	3.5	-	2.5	2.5	0A2	500
	RHEL81H103K0A2H03B	X8L	50	10000pF	±10%	3.6	3.5	-	2.5	2.5	0A2	500
	RHEL81H153K0A2H03B	X8L	50	15000pF	±10%	3.6	3.5	-	2.5	2.5	0A2	500
	RHEL81H223K0A2H03B	X8L	50	22000pF	±10%	3.6	3.5	-	2.5	2.5	0A2	500
	RHEL81H333K0A2H03B	X8L	50	33000pF	±10%	3.6	3.5	-	2.5	2.5	0A2	500
	RHEL81H473K0A2H03B	X8L	50	47000pF	±10%	3.6	3.5	-	2.5	2.5	0A2	500
	RHEL81H683K0A2H03B	X8L	50	68000pF	±10%	3.6	3.5	-	2.5	2.5	0A2	500
	RHEL81H104K0A2H03B	X8L	50	0.1μF	±10%	3.6	3.5	-	2.5	2.5	0A2	500
	RHEL81H154K1A2H03B	X8L	50	0.15μF	±10%	4.0	3.5	-	2.5	2.5	1A2	500
	RHEL81H224K1A2H03B	X8L	50	0.22μF	±10%	4.0	3.5	-	2.5	2.5	1A2	500
	RHEL81H334K1A2H03B	X8L	50	0.33μF	±10%	4.0	3.5	-	2.5	2.5	1A2	500
	RHEL81H474K2A2H03B	X8L	50	0.47μF	±10%	5.5	4.0	-	2.5	3.15	2A2	500
	RHEL81H684K2A2H03B	X8L	50	0.68μF	±10%	5.5	4.0	-	2.5	3.15	2A2	500
	RHEL81H105K2A2H03B	X8L	50	1.0μF	±10%	5.5	4.0	-	2.5	3.15	2A2	500
	RHEL81H155K2A2H03B	X8L	50	1.5μF	±10%	5.5	4.0	-	2.5	3.15	2A2	500
	RHEL81H225K2A2H03B	X8L	50	2.2μF	±10%	5.5	4.0	-	2.5	3.15	2A2	500
	RHEL81H335K3A2H03B	X8L	50	3.3μF	±10%	5.5	5.0	-	2.5	4.0	3A2	500
	RHEL81H475K3A2H03B	X8L	50	4.7μF	±10%	5.5	5.0	-	2.5	4.0	3A2	500
	RHEL82A221K0A2H03B	X8L	100	220pF	±10%	3.6	3.5	-	2.5	2.5	0A2	500

Reference only

• Straight Long  
(Lead Code:A2)

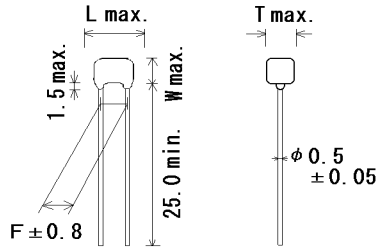

• Inside Crimp  
(Lead Code:K1)

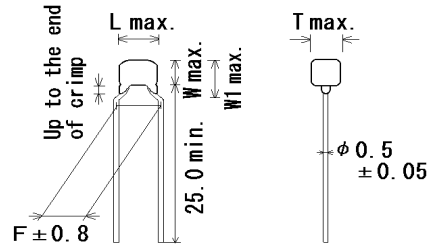

Unit : mm

Customer Part Number	Murata Part Number	T.C.	DC Rated Volt. (V)	Cap.	Cap. tol.	Dimension (mm)					Size Lead Code	Pack qty. (pcs)
						L	W	W1	F	T		
	RHEL82A331K0A2H03B	X8L	100	330pF	± 10%	3.6	3.5	-	2.5	2.5	0A2	500
	RHEL82A471K0A2H03B	X8L	100	470pF	± 10%	3.6	3.5	-	2.5	2.5	0A2	500
	RHEL82A681K0A2H03B	X8L	100	680pF	± 10%	3.6	3.5	-	2.5	2.5	0A2	500
	RHEL82A102K0A2H03B	X8L	100	1000pF	± 10%	3.6	3.5	-	2.5	2.5	0A2	500
	RHEL82A152K0A2H03B	X8L	100	1500pF	± 10%	3.6	3.5	-	2.5	2.5	0A2	500
	RHEL82A222K0A2H03B	X8L	100	2200pF	± 10%	3.6	3.5	-	2.5	2.5	0A2	500
	RHEL82A332K0A2H03B	X8L	100	3300pF	± 10%	3.6	3.5	-	2.5	2.5	0A2	500
	RHEL82A472K0A2H03B	X8L	100	4700pF	± 10%	3.6	3.5	-	2.5	2.5	0A2	500
	RHEL82A682K0A2H03B	X8L	100	6800pF	± 10%	3.6	3.5	-	2.5	2.5	0A2	500
	RHEL82A103K0A2H03B	X8L	100	10000pF	± 10%	3.6	3.5	-	2.5	2.5	0A2	500
	RHEL82A153K0A2H03B	X8L	100	15000pF	± 10%	3.6	3.5	-	2.5	2.5	0A2	500
	RHEL82A223K0A2H03B	X8L	100	22000pF	± 10%	3.6	3.5	-	2.5	2.5	0A2	500
	RHEL82A333K1A2H03B	X8L	100	33000pF	± 10%	4.0	3.5	-	2.5	2.5	1A2	500
	RHEL82A473K1A2H03B	X8L	100	47000pF	± 10%	4.0	3.5	-	2.5	2.5	1A2	500
	RHEL82A683K1A2H03B	X8L	100	68000pF	± 10%	4.0	3.5	-	2.5	2.5	1A2	500
	RHEL82A104K1A2H03B	X8L	100	0.1μF	± 10%	4.0	3.5	-	2.5	2.5	1A2	500
	RHEL82A154K2A2H03B	X8L	100	0.15μF	± 10%	5.5	4.0	-	2.5	3.15	2A2	500
	RHEL82A224K2A2H03B	X8L	100	0.22μF	± 10%	5.5	4.0	-	2.5	3.15	2A2	500
	RHEL81E104K0K1H03B	X8L	25	0.1μF	± 10%	3.6	3.5	6.0	5.0	2.5	0K1	500
	RHEL81E154K0K1H03B	X8L	25	0.15μF	± 10%	3.6	3.5	6.0	5.0	2.5	0K1	500
	RHEL81E224K0K1H03B	X8L	25	0.22μF	± 10%	3.6	3.5	6.0	5.0	2.5	0K1	500
	RHEL81E334K1K1H03B	X8L	25	0.33μF	± 10%	4.0	3.5	5.0	5.0	2.5	1K1	500
	RHEL81E474K1K1H03B	X8L	25	0.47μF	± 10%	4.0	3.5	5.0	5.0	2.5	1K1	500
	RHEL81E684K1K1H03B	X8L	25	0.68μF	± 10%	4.0	3.5	5.0	5.0	2.5	1K1	500
	RHEL81E105K1K1H03B	X8L	25	1.0μF	± 10%	4.0	3.5	5.0	5.0	2.5	1K1	500
	RHEL81E155K2K1H03B	X8L	25	1.5μF	± 10%	5.5	4.0	6.0	5.0	3.15	2K1	500
	RHEL81E225K2K1H03B	X8L	25	2.2μF	± 10%	5.5	4.0	6.0	5.0	3.15	2K1	500
	RHEL81E335K2K1H03B	X8L	25	3.3μF	± 10%	5.5	4.0	6.0	5.0	3.15	2K1	500
	RHEL81E475K2K1H03B	X8L	25	4.7μF	± 10%	5.5	4.0	6.0	5.0	3.15	2K1	500
	RHEL81E106K3K1H03B	X8L	25	10μF	± 10%	5.5	5.0	7.5	5.0	4.0	3K1	500
	RHEL81E226MWK1H03B	X8L	25	22μF	± 20%	5.5	7.5	10.0	5.0	4.0	WK1	500
	RHEL81H221K0K1H03B	X8L	50	220pF	± 10%	3.6	3.5	6.0	5.0	2.5	0K1	500
	RHEL81H331K0K1H03B	X8L	50	330pF	± 10%	3.6	3.5	6.0	5.0	2.5	0K1	500
	RHEL81H471K0K1H03B	X8L	50	470pF	± 10%	3.6	3.5	6.0	5.0	2.5	0K1	500
	RHEL81H681K0K1H03B	X8L	50	680pF	± 10%	3.6	3.5	6.0	5.0	2.5	0K1	500
	RHEL81H102K0K1H03B	X8L	50	1000pF	± 10%	3.6	3.5	6.0	5.0	2.5	0K1	500
	RHEL81H152K0K1H03B	X8L	50	1500pF	± 10%	3.6	3.5	6.0	5.0	2.5	0K1	500
	RHEL81H222K0K1H03B	X8L	50	2200pF	± 10%	3.6	3.5	6.0	5.0	2.5	0K1	500
	RHEL81H332K0K1H03B	X8L	50	3300pF	± 10%	3.6	3.5	6.0	5.0	2.5	0K1	500
	RHEL81H472K0K1H03B	X8L	50	4700pF	± 10%	3.6	3.5	6.0	5.0	2.5	0K1	500

Reference only

- Inside Crimp  
(Lead Code:K1)

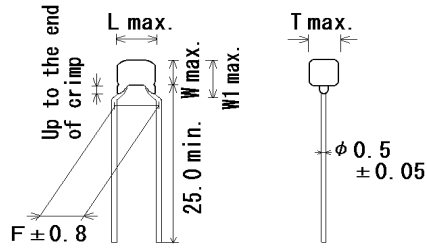

Unit : mm

Customer Part Number	Murata Part Number	T.C.	DC Rated Volt. (V)	Cap.	Cap. tol.	Dimension (mm)					Size Lead Code	Pack qty. (pcs)
						L	W	W1	F	T		
	RHEL81H682K0K1H03B	X8L	50	6800pF	±10%	3.6	3.5	6.0	5.0	2.5	0K1	500
	RHEL81H103K0K1H03B	X8L	50	10000pF	±10%	3.6	3.5	6.0	5.0	2.5	0K1	500
	RHEL81H153K0K1H03B	X8L	50	15000pF	±10%	3.6	3.5	6.0	5.0	2.5	0K1	500
	RHEL81H223K0K1H03B	X8L	50	22000pF	±10%	3.6	3.5	6.0	5.0	2.5	0K1	500
	RHEL81H333K0K1H03B	X8L	50	33000pF	±10%	3.6	3.5	6.0	5.0	2.5	0K1	500
	RHEL81H473K0K1H03B	X8L	50	47000pF	±10%	3.6	3.5	6.0	5.0	2.5	0K1	500
	RHEL81H683K0K1H03B	X8L	50	68000pF	±10%	3.6	3.5	6.0	5.0	2.5	0K1	500
	RHEL81H104K0K1H03B	X8L	50	0.1μF	±10%	3.6	3.5	6.0	5.0	2.5	0K1	500
	RHEL81H154K1K1H03B	X8L	50	0.15μF	±10%	4.0	3.5	5.0	5.0	2.5	1K1	500
	RHEL81H224K1K1H03B	X8L	50	0.22μF	±10%	4.0	3.5	5.0	5.0	2.5	1K1	500
	RHEL81H334K1K1H03B	X8L	50	0.33μF	±10%	4.0	3.5	5.0	5.0	2.5	1K1	500
	RHEL81H474K2K1H03B	X8L	50	0.47μF	±10%	5.5	4.0	6.0	5.0	3.15	2K1	500
	RHEL81H684K2K1H03B	X8L	50	0.68μF	±10%	5.5	4.0	6.0	5.0	3.15	2K1	500
	RHEL81H105K2K1H03B	X8L	50	1.0μF	±10%	5.5	4.0	6.0	5.0	3.15	2K1	500
	RHEL81H155K2K1H03B	X8L	50	1.5μF	±10%	5.5	4.0	6.0	5.0	3.15	2K1	500
	RHEL81H225K2K1H03B	X8L	50	2.2μF	±10%	5.5	4.0	6.0	5.0	3.15	2K1	500
	RHEL81H335K3K1H03B	X8L	50	3.3μF	±10%	5.5	5.0	7.5	5.0	4.0	3K1	500
	RHEL81H475K3K1H03B	X8L	50	4.7μF	±10%	5.5	5.0	7.5	5.0	4.0	3K1	500
	RHEL81H106MVK1H03B	X8L	50	10μF	±20%	5.5	7.5	10.0	5.0	4.0	WK1	500
	RHEL82A221K0K1H03B	X8L	100	220pF	±10%	3.6	3.5	6.0	5.0	2.5	0K1	500
	RHEL82A331K0K1H03B	X8L	100	330pF	±10%	3.6	3.5	6.0	5.0	2.5	0K1	500
	RHEL82A471K0K1H03B	X8L	100	470pF	±10%	3.6	3.5	6.0	5.0	2.5	0K1	500
	RHEL82A681K0K1H03B	X8L	100	680pF	±10%	3.6	3.5	6.0	5.0	2.5	0K1	500
	RHEL82A102K0K1H03B	X8L	100	1000pF	±10%	3.6	3.5	6.0	5.0	2.5	0K1	500
	RHEL82A152K0K1H03B	X8L	100	1500pF	±10%	3.6	3.5	6.0	5.0	2.5	0K1	500
	RHEL82A222K0K1H03B	X8L	100	2200pF	±10%	3.6	3.5	6.0	5.0	2.5	0K1	500
	RHEL82A332K0K1H03B	X8L	100	3300pF	±10%	3.6	3.5	6.0	5.0	2.5	0K1	500
	RHEL82A472K0K1H03B	X8L	100	4700pF	±10%	3.6	3.5	6.0	5.0	2.5	0K1	500
	RHEL82A682K0K1H03B	X8L	100	6800pF	±10%	3.6	3.5	6.0	5.0	2.5	0K1	500
	RHEL82A103K0K1H03B	X8L	100	10000pF	±10%	3.6	3.5	6.0	5.0	2.5	0K1	500
	RHEL82A153K0K1H03B	X8L	100	15000pF	±10%	3.6	3.5	6.0	5.0	2.5	0K1	500
	RHEL82A223K0K1H03B	X8L	100	22000pF	±10%	3.6	3.5	6.0	5.0	2.5	0K1	500
	RHEL82A333K1K1H03B	X8L	100	33000pF	±10%	4.0	3.5	5.0	5.0	2.5	1K1	500
	RHEL82A473K1K1H03B	X8L	100	47000pF	±10%	4.0	3.5	5.0	5.0	2.5	1K1	500
	RHEL82A683K1K1H03B	X8L	100	68000pF	±10%	4.0	3.5	5.0	5.0	2.5	1K1	500
	RHEL82A104K1K1H03B	X8L	100	0.1μF	±10%	4.0	3.5	5.0	5.0	2.5	1K1	500
	RHEL82A154K2K1H03B	X8L	100	0.15μF	±10%	5.5	4.0	6.0	5.0	3.15	2K1	500
	RHEL82A224K2K1H03B	X8L	100	0.22μF	±10%	5.5	4.0	6.0	5.0	3.15	2K1	500



Reference only

- Straight Taping  
(Lead Code:DB)

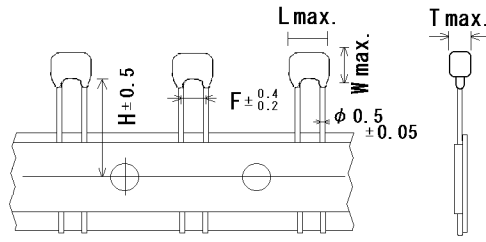

Unit : mm

Customer Part Number	Murata Part Number	T.C.	DC Rated volt. (V)	Cap.	Cap. tol.	Dimension (mm)						Size Lead Code	Pack qty. (pcs)
						L	W	W1	F	T	H0		
	RHEL81E104K0DBH03A	X8L	25	0.1 $\mu$ F	$\pm 10\%$	3.6	3.5	-	2.5	2.5	16.0	0DB	2000
	RHEL81E154K0DBH03A	X8L	25	0.15 $\mu$ F	$\pm 10\%$	3.6	3.5	-	2.5	2.5	16.0	0DB	2000
	RHEL81E224K0DBH03A	X8L	25	0.22 $\mu$ F	$\pm 10\%$	3.6	3.5	-	2.5	2.5	16.0	0DB	2000
	RHEL81E334K1DBH03A	X8L	25	0.33 $\mu$ F	$\pm 10\%$	4.0	3.5	-	2.5	2.5	16.0	1DB	2000
	RHEL81E474K1DBH03A	X8L	25	0.47 $\mu$ F	$\pm 10\%$	4.0	3.5	-	2.5	2.5	16.0	1DB	2000
	RHEL81E684K1DBH03A	X8L	25	0.68 $\mu$ F	$\pm 10\%$	4.0	3.5	-	2.5	2.5	16.0	1DB	2000
	RHEL81E105K1DBH03A	X8L	25	1.0 $\mu$ F	$\pm 10\%$	4.0	3.5	-	2.5	2.5	16.0	1DB	2000
	RHEL81E155K2DBH03A	X8L	25	1.5 $\mu$ F	$\pm 10\%$	5.5	4.0	-	2.5	3.15	16.0	2DB	2000
	RHEL81E225K2DBH03A	X8L	25	2.2 $\mu$ F	$\pm 10\%$	5.5	4.0	-	2.5	3.15	16.0	2DB	2000
	RHEL81E335K2DBH03A	X8L	25	3.3 $\mu$ F	$\pm 10\%$	5.5	4.0	-	2.5	3.15	16.0	2DB	2000
	RHEL81E475K2DBH03A	X8L	25	4.7 $\mu$ F	$\pm 10\%$	5.5	4.0	-	2.5	3.15	16.0	2DB	2000
	RHEL81E106K3DBH03A	X8L	25	10 $\mu$ F	$\pm 10\%$	5.5	5.0	-	2.5	4.0	16.0	3DB	1500
	RHEL81H221K0DBH03A	X8L	50	220pF	$\pm 10\%$	3.6	3.5	-	2.5	2.5	16.0	0DB	2000
	RHEL81H331K0DBH03A	X8L	50	330pF	$\pm 10\%$	3.6	3.5	-	2.5	2.5	16.0	0DB	2000
	RHEL81H471K0DBH03A	X8L	50	470pF	$\pm 10\%$	3.6	3.5	-	2.5	2.5	16.0	0DB	2000
	RHEL81H681K0DBH03A	X8L	50	680pF	$\pm 10\%$	3.6	3.5	-	2.5	2.5	16.0	0DB	2000
	RHEL81H102K0DBH03A	X8L	50	1000pF	$\pm 10\%$	3.6	3.5	-	2.5	2.5	16.0	0DB	2000
	RHEL81H152K0DBH03A	X8L	50	1500pF	$\pm 10\%$	3.6	3.5	-	2.5	2.5	16.0	0DB	2000
	RHEL81H222K0DBH03A	X8L	50	2200pF	$\pm 10\%$	3.6	3.5	-	2.5	2.5	16.0	0DB	2000
	RHEL81H332K0DBH03A	X8L	50	3300pF	$\pm 10\%$	3.6	3.5	-	2.5	2.5	16.0	0DB	2000
	RHEL81H472K0DBH03A	X8L	50	4700pF	$\pm 10\%$	3.6	3.5	-	2.5	2.5	16.0	0DB	2000
	RHEL81H682K0DBH03A	X8L	50	6800pF	$\pm 10\%$	3.6	3.5	-	2.5	2.5	16.0	0DB	2000
	RHEL81H103K0DBH03A	X8L	50	10000pF	$\pm 10\%$	3.6	3.5	-	2.5	2.5	16.0	0DB	2000
	RHEL81H153K0DBH03A	X8L	50	15000pF	$\pm 10\%$	3.6	3.5	-	2.5	2.5	16.0	0DB	2000
	RHEL81H223K0DBH03A	X8L	50	22000pF	$\pm 10\%$	3.6	3.5	-	2.5	2.5	16.0	0DB	2000
	RHEL81H333K0DBH03A	X8L	50	33000pF	$\pm 10\%$	3.6	3.5	-	2.5	2.5	16.0	0DB	2000
	RHEL81H473K0DBH03A	X8L	50	47000pF	$\pm 10\%$	3.6	3.5	-	2.5	2.5	16.0	0DB	2000
	RHEL81H683K0DBH03A	X8L	50	68000pF	$\pm 10\%$	3.6	3.5	-	2.5	2.5	16.0	0DB	2000
	RHEL81H104K0DBH03A	X8L	50	0.1 $\mu$ F	$\pm 10\%$	3.6	3.5	-	2.5	2.5	16.0	0DB	2000
	RHEL81H154K1DBH03A	X8L	50	0.15 $\mu$ F	$\pm 10\%$	4.0	3.5	-	2.5	2.5	16.0	1DB	2000
	RHEL81H224K1DBH03A	X8L	50	0.22 $\mu$ F	$\pm 10\%$	4.0	3.5	-	2.5	2.5	16.0	1DB	2000
	RHEL81H334K1DBH03A	X8L	50	0.33 $\mu$ F	$\pm 10\%$	4.0	3.5	-	2.5	2.5	16.0	1DB	2000
	RHEL81H474K2DBH03A	X8L	50	0.47 $\mu$ F	$\pm 10\%$	5.5	4.0	-	2.5	3.15	16.0	2DB	2000
	RHEL81H684K2DBH03A	X8L	50	0.68 $\mu$ F	$\pm 10\%$	5.5	4.0	-	2.5	3.15	16.0	2DB	2000
	RHEL81H105K2DBH03A	X8L	50	1.0 $\mu$ F	$\pm 10\%$	5.5	4.0	-	2.5	3.15	16.0	2DB	2000
	RHEL81H155K2DBH03A	X8L	50	1.5 $\mu$ F	$\pm 10\%$	5.5	4.0	-	2.5	3.15	16.0	2DB	2000
	RHEL81H225K2DBH03A	X8L	50	2.2 $\mu$ F	$\pm 10\%$	5.5	4.0	-	2.5	3.15	16.0	2DB	2000
	RHEL81H335K3DBH03A	X8L	50	3.3 $\mu$ F	$\pm 10\%$	5.5	5.0	-	2.5	4.0	16.0	3DB	2000
	RHEL81H475K3DBH03A	X8L	50	4.7 $\mu$ F	$\pm 10\%$	5.5	5.0	-	2.5	4.0	16.0	3DB	2000
	RHEL82A221K0DBH03A	X8L	100	220pF	$\pm 10\%$	3.6	3.5	-	2.5	2.5	16.0	0DB	2000

Reference only

• Straight Taping  
(Lead Code: DB)

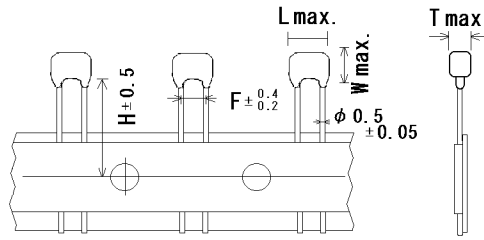

• Inside Crimp Taping  
(Lead Code: M\*)

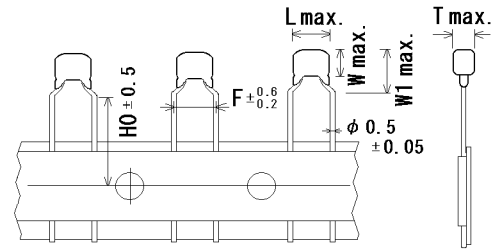

Unit : mm

Customer Part Number	Murata Part Number	T.C.	DC Rated volt. (V)	Cap.	Cap. tol.	Dimension (mm)						Size Lead Code	Pack qty. (pcs)
						L	W	W1	F	T	H0		
	RHEL82A331K0DBH03A	X8L	100	330pF	±10%	3.6	3.5	-	2.5	2.5	16.0	0DB	2000
	RHEL82A471K0DBH03A	X8L	100	470pF	±10%	3.6	3.5	-	2.5	2.5	16.0	0DB	2000
	RHEL82A681K0DBH03A	X8L	100	680pF	±10%	3.6	3.5	-	2.5	2.5	16.0	0DB	2000
	RHEL82A102K0DBH03A	X8L	100	1000pF	±10%	3.6	3.5	-	2.5	2.5	16.0	0DB	2000
	RHEL82A152K0DBH03A	X8L	100	1500pF	±10%	3.6	3.5	-	2.5	2.5	16.0	0DB	2000
	RHEL82A222K0DBH03A	X8L	100	2200pF	±10%	3.6	3.5	-	2.5	2.5	16.0	0DB	2000
	RHEL82A332K0DBH03A	X8L	100	3300pF	±10%	3.6	3.5	-	2.5	2.5	16.0	0DB	2000
	RHEL82A472K0DBH03A	X8L	100	4700pF	±10%	3.6	3.5	-	2.5	2.5	16.0	0DB	2000
	RHEL82A682K0DBH03A	X8L	100	6800pF	±10%	3.6	3.5	-	2.5	2.5	16.0	0DB	2000
	RHEL82A103K0DBH03A	X8L	100	10000pF	±10%	3.6	3.5	-	2.5	2.5	16.0	0DB	2000
	RHEL82A153K0DBH03A	X8L	100	15000pF	±10%	3.6	3.5	-	2.5	2.5	16.0	0DB	2000
	RHEL82A223K0DBH03A	X8L	100	22000pF	±10%	3.6	3.5	-	2.5	2.5	16.0	0DB	2000
	RHEL82A333K1DBH03A	X8L	100	33000pF	±10%	4.0	3.5	-	2.5	2.5	16.0	1DB	2000
	RHEL82A473K1DBH03A	X8L	100	47000pF	±10%	4.0	3.5	-	2.5	2.5	16.0	1DB	2000
	RHEL82A683K1DBH03A	X8L	100	68000pF	±10%	4.0	3.5	-	2.5	2.5	16.0	1DB	2000
	RHEL82A104K1DBH03A	X8L	100	0.1μF	±10%	4.0	3.5	-	2.5	2.5	16.0	1DB	2000
	RHEL82A154K2DBH03A	X8L	100	0.15μF	±10%	5.5	4.0	-	2.5	3.15	16.0	2DB	2000
	RHEL82A224K2DBH03A	X8L	100	0.22μF	±10%	5.5	4.0	-	2.5	3.15	16.0	2DB	2000
	RHEL81E104K0M1H03A	X8L	25	0.1μF	±10%	3.6	3.5	6.0	5.0	2.5	16.0	0M1	2000
	RHEL81E154K0M1H03A	X8L	25	0.15μF	±10%	3.6	3.5	6.0	5.0	2.5	16.0	0M1	2000
	RHEL81E224K0M1H03A	X8L	25	0.22μF	±10%	3.6	3.5	6.0	5.0	2.5	16.0	0M1	2000
	RHEL81E334K1M1H03A	X8L	25	0.33μF	±10%	4.0	3.5	5.0	5.0	2.5	16.0	1M1	2000
	RHEL81E474K1M1H03A	X8L	25	0.47μF	±10%	4.0	3.5	5.0	5.0	2.5	16.0	1M1	2000
	RHEL81E684K1M1H03A	X8L	25	0.68μF	±10%	4.0	3.5	5.0	5.0	2.5	16.0	1M1	2000
	RHEL81E105K1M1H03A	X8L	25	1.0μF	±10%	4.0	3.5	5.0	5.0	2.5	16.0	1M1	2000
	RHEL81E155K2M1H03A	X8L	25	1.5μF	±10%	5.5	4.0	6.0	5.0	3.15	16.0	2M1	2000
	RHEL81E225K2M1H03A	X8L	25	2.2μF	±10%	5.5	4.0	6.0	5.0	3.15	16.0	2M1	2000
	RHEL81E335K2M1H03A	X8L	25	3.3μF	±10%	5.5	4.0	6.0	5.0	3.15	16.0	2M1	2000
	RHEL81E475K2M1H03A	X8L	25	4.7μF	±10%	5.5	4.0	6.0	5.0	3.15	16.0	2M1	2000
	RHEL81E106K3M1H03A	X8L	25	10μF	±10%	5.5	5.0	7.5	5.0	4.0	16.0	3M1	1500
	RHEL81E226MWM1H03A	X8L	25	22μF	±20%	5.5	7.5	10.0	5.0	4.0	16.0	WM1	1500
	RHEL81H221K0M1H03A	X8L	50	220pF	±10%	3.6	3.5	6.0	5.0	2.5	16.0	0M1	2000
	RHEL81H331K0M1H03A	X8L	50	330pF	±10%	3.6	3.5	6.0	5.0	2.5	16.0	0M1	2000
	RHEL81H471K0M1H03A	X8L	50	470pF	±10%	3.6	3.5	6.0	5.0	2.5	16.0	0M1	2000
	RHEL81H681K0M1H03A	X8L	50	680pF	±10%	3.6	3.5	6.0	5.0	2.5	16.0	0M1	2000
	RHEL81H102K0M1H03A	X8L	50	1000pF	±10%	3.6	3.5	6.0	5.0	2.5	16.0	0M1	2000
	RHEL81H152K0M1H03A	X8L	50	1500pF	±10%	3.6	3.5	6.0	5.0	2.5	16.0	0M1	2000
	RHEL81H222K0M1H03A	X8L	50	2200pF	±10%	3.6	3.5	6.0	5.0	2.5	16.0	0M1	2000
	RHEL81H332K0M1H03A	X8L	50	3300pF	±10%	3.6	3.5	6.0	5.0	2.5	16.0	0M1	2000
	RHEL81H472K0M1H03A	X8L	50	4700pF	±10%	3.6	3.5	6.0	5.0	2.5	16.0	0M1	2000

Reference only

• Inside Crimp Taping  
(Lead Code: M\*)

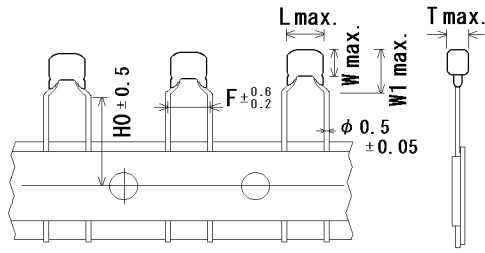

Unit : mm

Customer Part Number	Murata Part Number	T.C.	DC Rated volt. (V)	Cap.	Cap. tol.	Dimension (mm)						Size Lead Code	Pack qty. (pcs)
						L	W	W1	F	T	H0		
	RHEL81H682K0M1H03A	X8L	50	6800pF	±10%	3.6	3.5	6.0	5.0	2.5	16.0	0M1	2000
	RHEL81H103K0M1H03A	X8L	50	10000pF	±10%	3.6	3.5	6.0	5.0	2.5	16.0	0M1	2000
	RHEL81H153K0M1H03A	X8L	50	15000pF	±10%	3.6	3.5	6.0	5.0	2.5	16.0	0M1	2000
	RHEL81H223K0M1H03A	X8L	50	22000pF	±10%	3.6	3.5	6.0	5.0	2.5	16.0	0M1	2000
	RHEL81H333K0M1H03A	X8L	50	33000pF	±10%	3.6	3.5	6.0	5.0	2.5	16.0	0M1	2000
	RHEL81H473K0M1H03A	X8L	50	47000pF	±10%	3.6	3.5	6.0	5.0	2.5	16.0	0M1	2000
	RHEL81H683K0M1H03A	X8L	50	68000pF	±10%	3.6	3.5	6.0	5.0	2.5	16.0	0M1	2000
	RHEL81H104K0M1H03A	X8L	50	0.1μF	±10%	3.6	3.5	6.0	5.0	2.5	16.0	0M1	2000
	RHEL81H154K1M1H03A	X8L	50	0.15μF	±10%	4.0	3.5	5.0	5.0	2.5	16.0	1M1	2000
	RHEL81H224K1M1H03A	X8L	50	0.22μF	±10%	4.0	3.5	5.0	5.0	2.5	16.0	1M1	2000
	RHEL81H334K1M1H03A	X8L	50	0.33μF	±10%	4.0	3.5	5.0	5.0	2.5	16.0	1M1	2000
	RHEL81H474K2M1H03A	X8L	50	0.47μF	±10%	5.5	4.0	6.0	5.0	3.15	16.0	2M1	2000
	RHEL81H684K2M1H03A	X8L	50	0.68μF	±10%	5.5	4.0	6.0	5.0	3.15	16.0	2M1	2000
	RHEL81H105K2M1H03A	X8L	50	1.0μF	±10%	5.5	4.0	6.0	5.0	3.15	16.0	2M1	2000
	RHEL81H155K2M1H03A	X8L	50	1.5μF	±10%	5.5	4.0	6.0	5.0	3.15	16.0	2M1	2000
	RHEL81H225K2M1H03A	X8L	50	2.2μF	±10%	5.5	4.0	6.0	5.0	3.15	16.0	2M1	2000
	RHEL81H335K3M1H03A	X8L	50	3.3μF	±10%	5.5	5.0	7.5	5.0	4.0	16.0	3M1	1500
	RHEL81H475K3M1H03A	X8L	50	4.7μF	±10%	5.5	5.0	7.5	5.0	4.0	16.0	3M1	1500
	RHEL81H106MWM1H03A	X8L	50	10μF	±20%	5.5	7.5	10.0	5.0	4.0	16.0	WM1	1500
	RHEL82A221K0M1H03A	X8L	100	220pF	±10%	3.6	3.5	6.0	5.0	2.5	16.0	0M1	2000
	RHEL82A331K0M1H03A	X8L	100	330pF	±10%	3.6	3.5	6.0	5.0	2.5	16.0	0M1	2000
	RHEL82A471K0M1H03A	X8L	100	470pF	±10%	3.6	3.5	6.0	5.0	2.5	16.0	0M1	2000
	RHEL82A681K0M1H03A	X8L	100	680pF	±10%	3.6	3.5	6.0	5.0	2.5	16.0	0M1	2000
	RHEL82A102K0M1H03A	X8L	100	1000pF	±10%	3.6	3.5	6.0	5.0	2.5	16.0	0M1	2000
	RHEL82A152K0M1H03A	X8L	100	1500pF	±10%	3.6	3.5	6.0	5.0	2.5	16.0	0M1	2000
	RHEL82A222K0M1H03A	X8L	100	2200pF	±10%	3.6	3.5	6.0	5.0	2.5	16.0	0M1	2000
	RHEL82A332K0M1H03A	X8L	100	3300pF	±10%	3.6	3.5	6.0	5.0	2.5	16.0	0M1	2000
	RHEL82A472K0M1H03A	X8L	100	4700pF	±10%	3.6	3.5	6.0	5.0	2.5	16.0	0M1	2000
	RHEL82A682K0M1H03A	X8L	100	6800pF	±10%	3.6	3.5	6.0	5.0	2.5	16.0	0M1	2000
	RHEL82A103K0M1H03A	X8L	100	10000pF	±10%	3.6	3.5	6.0	5.0	2.5	16.0	0M1	2000
	RHEL82A153K0M1H03A	X8L	100	15000pF	±10%	3.6	3.5	6.0	5.0	2.5	16.0	0M1	2000
	RHEL82A223K0M1H03A	X8L	100	22000pF	±10%	3.6	3.5	6.0	5.0	2.5	16.0	0M1	2000
	RHEL82A333K1M1H03A	X8L	100	33000pF	±10%	4.0	3.5	5.0	5.0	2.5	16.0	1M1	2000
	RHEL82A473K1M1H03A	X8L	100	47000pF	±10%	4.0	3.5	5.0	5.0	2.5	16.0	1M1	2000
	RHEL82A683K1M1H03A	X8L	100	68000pF	±10%	4.0	3.5	5.0	5.0	2.5	16.0	1M1	2000
	RHEL82A104K1M1H03A	X8L	100	0.1μF	±10%	4.0	3.5	5.0	5.0	2.5	16.0	1M1	2000
	RHEL82A154K2M1H03A	X8L	100	0.15μF	±10%	5.5	4.0	6.0	5.0	3.15	16.0	2M1	2000
	RHEL82A224K2M1H03A	X8L	100	0.22μF	±10%	5.5	4.0	6.0	5.0	3.15	16.0	2M1	2000

## Reference only

5. AEC-Q200 Murata Standard Specifications and Test Methods				
No.	AEC-Q200 Test Item	Specification	AEC-Q200 Test Method	
1	Pre-and Post-Stress Electrical Test		-	
2	High Temperature Exposure (Storage)	Appearance	No defects or abnormalities	
		Capacitance Change	within $\pm 12.5\%$	
		D.F.	0.04 max.	
		I.R.	More than 1,000M $\Omega$ or 50 M $\Omega$ - $\mu$ F (Whichever is smaller)	
3	Temperature Cycling	Appearance	No defects or abnormalities except color change of outer coating.	
		Capacitance Change	within $\pm 12.5\%$	
		D.F.	0.05 max.	
		I.R.	1,000M $\Omega$ or 50M $\Omega$ - $\mu$ F min. (Whichever is smaller)	
Step	1	2	3	4
Temp. ( $^{\circ}$ C)	-55+0/-3	Room Temp.	150+3/-0	Room Temp.
Time (min.)	15 $\pm$ 3	1	15 $\pm$ 3	1
4	Moisture Resistance	Appearance	No defects or abnormalities	
		Capacitance Change	within $\pm 12.5\%$	
		D.F.	0.05 max.	
		I.R.	500M $\Omega$ or 25M $\Omega$ - $\mu$ F min. (Whichever is smaller)	
5	Biased Humidity	Appearance	No defects or abnormalities	
		Capacitance Change	within $\pm 12.5\%$	
		D.F.	0.05 max.	
		I.R.	500M $\Omega$ or 25M $\Omega$ - $\mu$ F min. (Whichever is smaller)	
6	Operational Life	Appearance	No defects or abnormalities except color change of outer coating.	
		Capacitance Change	within $\pm 12.5\%$	
		D.F.	0.04 max.	
		I.R.	1,000M $\Omega$ or 50M $\Omega$ - $\mu$ F min. (Whichever is smaller)	
7	External Visual	No defects or abnormalities	Visual inspection	
8	Physical Dimension	Within the specified dimensions	Using calipers and micrometers.	
9	Marking	To be easily legible.	Visual inspection	
10	Resistance to Solvents	Appearance	No defects or abnormalities	
		Capacitance	Within the specified tolerance	
		D.F.	0.025 max.	
		I.R.	More than 10,000M $\Omega$ or 500 M $\Omega$ - $\mu$ F (Whichever is smaller)	

\* "room condition" Temperature: 15 to 35 $^{\circ}$ C, Relative humidity: 45 to 75%, Atmosphere pressure: 86 to 106kPa

## Reference only

No.	AEC-Q200 Test Item	Specification	AEC-Q200 Test Method
11	Mechanical Shock	Appearance	No defects or abnormalities
		Capacitance	Within the specified tolerance
		D.F.	0.025 max.
12	Vibration	Appearance	No defects or abnormalities
		Capacitance	Within the specified tolerance
		D.F.	0.025 max.
13-1	Resistance to Soldering Heat (Non-Preheat)	Appearance	No defects or abnormalities
		Capacitance Change	Within $\pm 7.5\%$
		Dielectric Strength (Between terminals)	No defects
13-2	Resistance to Soldering Heat (On-Preheat)	Appearance	No defects or abnormalities
		Capacitance Change	Within $\pm 7.5\%$
		Dielectric Strength (Between terminals)	No defects
13-3	Resistance to Soldering Heat (soldering iron method)	Appearance	No defects or abnormalities
		Capacitance Change	Within $\pm 7.5\%$
		Dielectric Strength (Between terminals)	No defects
14	Thermal Shock	Appearance	No defects or abnormalities
		Capacitance Change	within $\pm 12.5\%$
		D.F.	0.05 max.
		I.R.	1,000M $\Omega$ or 50M $\Omega$ · $\mu$ F min. (Whichever is smaller)
15	ESD	Appearance	No defects or abnormalities
		Capacitance	Within the specified tolerance
		D.F.	0.025 max.
		I.R.	More than 10,000M $\Omega$ or 500 M $\Omega$ · $\mu$ F (Whichever is smaller)
16	Solderability	Lead wire should be soldered with uniform coating on the axial direction over 95% of the circumferential direction.	<p>The terminal of a capacitor is dipped into a solution of ethanol (JIS-K-8101) and rosin (JIS-K-5902) (25% rosin in weight proportion) and then into molten solder (JIS-Z-3282) for 2<math>\pm</math>0.5 sec. In both cases the depth of dipping is up to about 1.5 to 2mm from the terminal body.</p> <p>Temp. of solder :                      245<math>\pm</math>5°C Lead Free Solder(Sn-3.0Ag-0.5Cu)                      235<math>\pm</math>5°C H60A or H63A Eutectic Solder</p>

\* "room condition" Temperature:15 to 35°C, Relative humidity:45 to 75%, Atmosphere pressure:86 to 106kPa

## Reference only

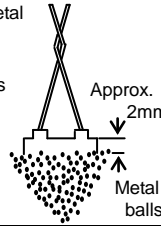
No.	AEC-Q200 Test Item	Specifications	AEC-Q200 Test Method												
17	Electrical Characterization	Appearance	No defects or abnormalities	Visual inspection.											
		Capacitance	Within the specified tolerance	The capacitance/D.F. should be measured at 25°C at the frequency and voltage shown in the table.											
		D.F.	0.025 max.												
		Insulation Resistance (I.R.)	Room Temperature	10,000MΩ or 500MΩ·μF min. (Whichever is smaller)	The insulation resistance should be measured at 25±3 °C with a DC voltage not exceeding the rated voltage at normal temperature and humidity and within 2 min. of charging. (Charge/Discharge current ≤ 50mA)										
			High Temperature	100MΩ or 5MΩ·μF min. (Whichever is smaller)	The insulation resistance should be measured at 150±3 °C with a DC voltage not exceeding the rated voltage at normal temperature and humidity and within 2 min. of charging. (Charge/Discharge current ≤ 50mA)										
Dielectric Strength	Between Terminals	No defects or abnormalities	The capacitor should not be damaged when DC voltage of 250% of the rated voltage is applied between the terminations for 1 to 5 seconds. (Charge/Discharge current ≤ 50mA.)												
	Body Insulation	No defects or abnormalities	The capacitor is placed in a container with metal balls of 1mm diameter so that each terminal, short-circuit is kept approximately 2mm from the balls, and 250% of the rated DC voltage is impressed for 1 to 5 seconds between capacitor terminals and metal balls. (Charge/Discharge current ≤ 50mA.)												
															
18	Terminal Strength	Tensile Strength	Termination not to be broken or loosened	As in the figure, fix the capacitor body, apply the force gradually to each lead in the radial direction of the capacitor until reaching 10N and then keep the force applied for 10±1 seconds.											
		Bending Strength	Termination not to be broken or loosened	Each lead wire should be subjected to a force of 2.5N and then be bent 90° at the point of egress in one direction. Each wire is then returned to the original position and bent 90° in the opposite direction at the rate of one bend per 2 to 3 seconds.											
19	Capacitance Temperature Characteristics	Within the specified Tolerance. -55 to 125°C : within ±15% 125 to 150°C :within +15/-40%	<p>The capacitance change should be measured after 5min. at each specified temperature step.</p> <table border="1" style="margin-left: auto; margin-right: auto;"> <thead> <tr> <th>Step</th> <th>Temperature(°C)</th> </tr> </thead> <tbody> <tr> <td>1</td> <td>25±2</td> </tr> <tr> <td>2</td> <td>-55±3</td> </tr> <tr> <td>3</td> <td>25±2</td> </tr> <tr> <td>4</td> <td>150±3</td> </tr> <tr> <td>5</td> <td>25±2</td> </tr> </tbody> </table> <p>The ranges of capacitance change compared with the above 25°C value over the temperature ranges shown in the table should be within the specified ranges.</p> <p>•Pretreatment Perform the heat treatment at 150+0/-10°C for 60±5 min and then let sit for 24±2 h at *room condition. Perform the initial measurement.</p>	Step	Temperature(°C)	1	25±2	2	-55±3	3	25±2	4	150±3	5	25±2
Step	Temperature(°C)														
1	25±2														
2	-55±3														
3	25±2														
4	150±3														
5	25±2														
* "room condition" Temperature:15 to 35°C, Relative humidity:45 to 75%, Atmosphere pressure:86 to 106kPa															

Reference only

6. Packing specification

- Bulk type (Packing style code : B)

The number of packing =  $\frac{\text{Packing quantity}}{n} \times n$

The size of packing case and packing way

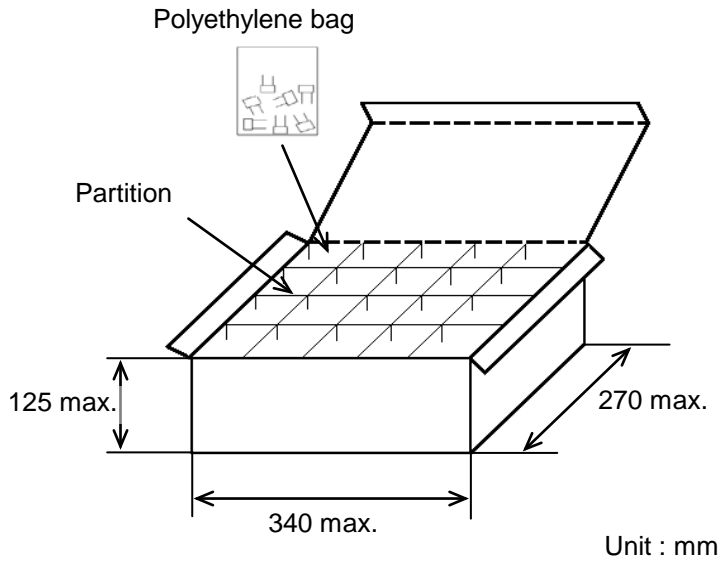

- \*1 : Please refer to [Part number list].
- \*2 : Standard n = 20 (bag)

Note)  
The outer package and the number of outer packing be changed by the order getting amount.

- Ammo pack taping type (Packing style code : A)

- A crease is made every 25 pitches, and the tape with capacitors is packed zigzag into a case.
- When body of the capacitor is piled on other body under it.

The size of packing case and packing way

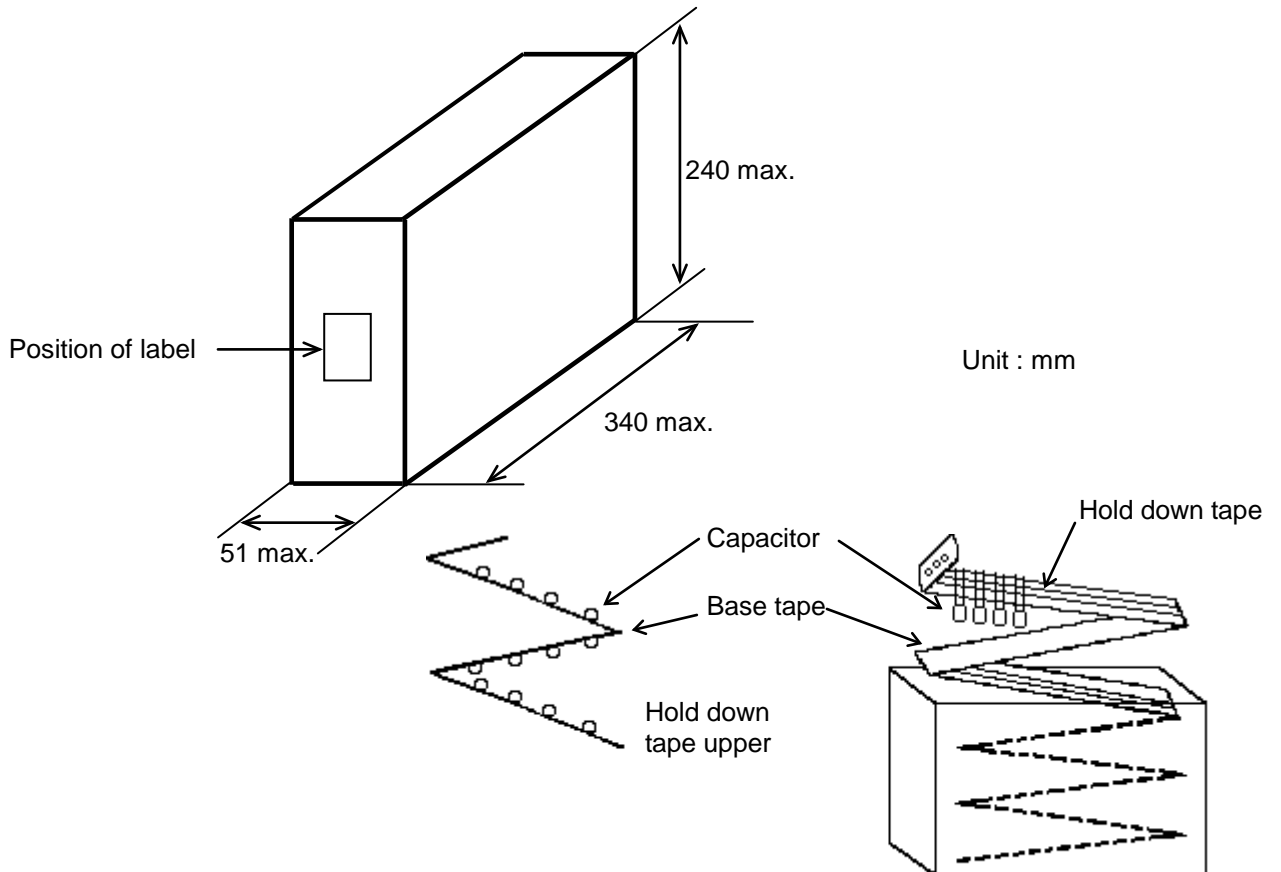

## Reference only

### 7. Taping specification

#### 7-1. Dimension of capacitors on tape

Straight taping type < Lead code : DB >

Pitch of component 12.7mm / Lead spacing 2.5mm

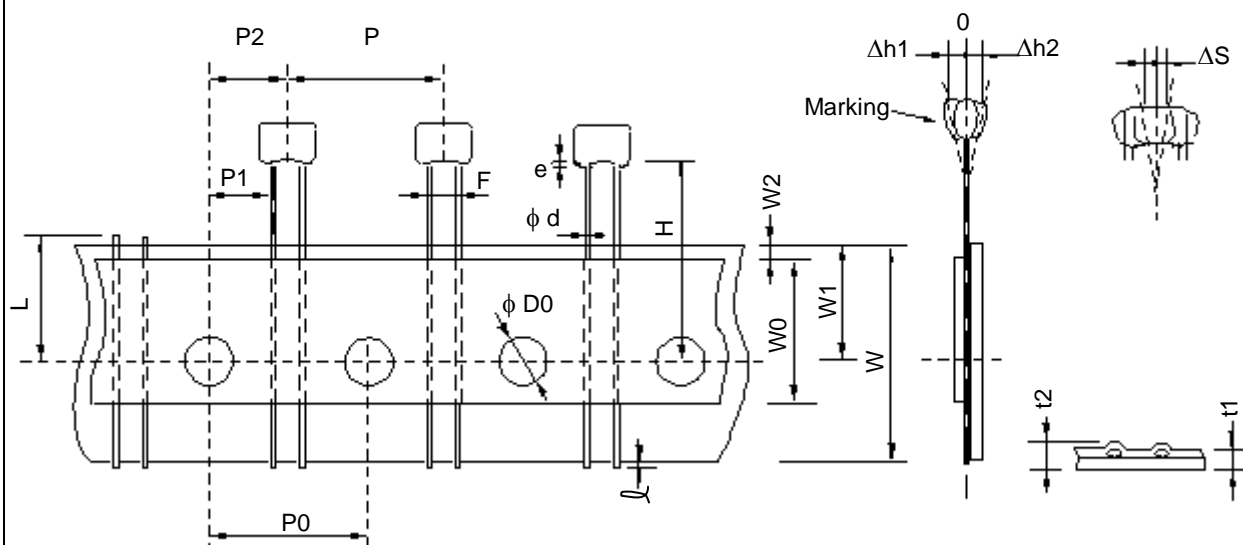

Unit : mm

Item	Code	Dimensions	Remarks
Pitch of component	P	12.7+/-1.0	
Pitch of sprocket hole	P0	12.7+/-0.2	
Lead spacing	F	2.5+0.4/-0.2	
Length from hole center to component center	P2	6.35+/-1.3	Deviation of progress direction
Length from hole center to lead	P1	5.1+/-0.7	
Deviation along tape, left or right defect	$\Delta S$	0+/-2.0	They include deviation by lead bend .
Carrier tape width	W	18.0+/-0.5	
Position of sprocket hole	W1	9.0+0/-0.5	Deviation of tape width direction
Lead distance between reference and bottom plane	H	16.0+/-0.5	
Protrusion length	$l$	0.5 max.	
Diameter of sprocket hole	D0	4.0+/-0.1	
Lead diameter	d	0.50+/-0.05	
Total tape thickness	t1	0.6+/-0.3	They include hold down tape thickness.
Total thickness of tape and lead wire	t2	1.5 max.	
Deviation across tape	$\Delta h1$	1.0 max.	
	$\Delta h2$		
Portion to cut in case of defect	L	11.0+0/-1.0	
Hold down tape width	W0	9.5 min.	
Hold down tape position	W2	1.5+/-1.5	
Coating extension on lead	e	1.5 max.	



Reference only

Inside crimp tapping type < Lead code : M1 >  
Pitch of component 12.7mm / Lead spacing 5.0mm

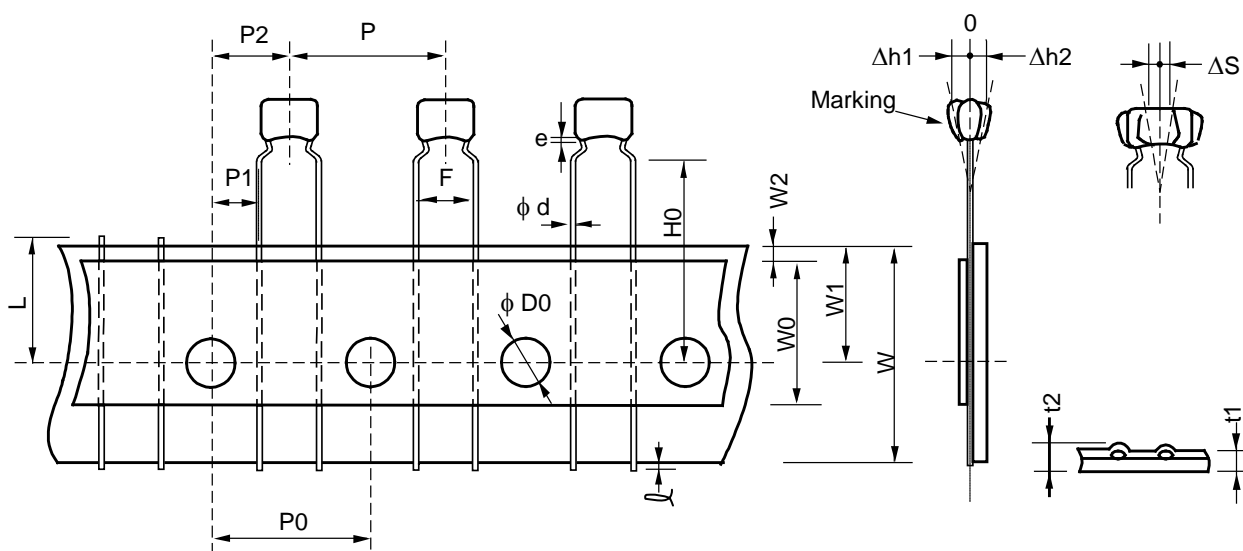

Unit : mm

Item	Code	Dimensions	Remarks
Pitch of component	P	12.7+/-1.0	
Pitch of sprocket hole	P0	12.7+/-0.2	
Lead spacing	F	5.0+0.6/-0.2	
Length from hole center to component center	P2	6.35+/-1.3	Deviation of progress direction
Length from hole center to lead	P1	3.85+/-0.7	
Deviation along tape, left or right defect	ΔS	0+/-2.0	They include deviation by lead bend .
Carrier tape width	W	18.0+/-0.5	
Position of sprocket hole	W1	9.0+0/-0.5	Deviation of tape width direction
Lead distance between reference and bottom plane	H0	16.0+/-0.5	
Protrusion length	ℓ	0.5 max.	
Diameter of sprocket hole	D0	4.0+/-0.1	
Lead diameter	φd	0.50+/-0.05	
Total tape thickness	t1	0.6+/-0.3	They include hold down tape thickness.
Total thickness of tape and lead wire	t2	1.5 max.	
Deviation across tape	Δh1	2.0 max. (Dimension code : W)	
	Δh2	1.0 max. (except as above)	
Portion to cut in case of defect	L	11.0+0/-1.0	
Hold down tape width	W0	9.5 min.	
Hold down tape position	W2	1.5+/-1.5	
Coating extension on lead	e	Up to the end of crimp	

## Reference only

### 7-2. Splicing way of tape

- 1) Adhesive force of tape is over 3N at test condition as below.

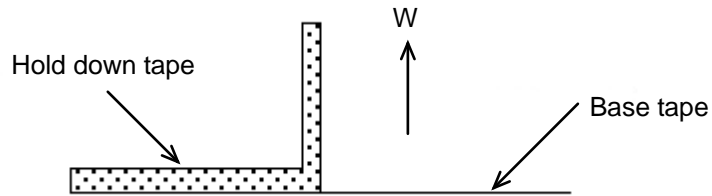

### 2) Splicing of tape

- a) When base tape is spliced

- Base tape shall be spliced by cellophane tape.  
(Total tape thickness shall be less than 1.05mm.)

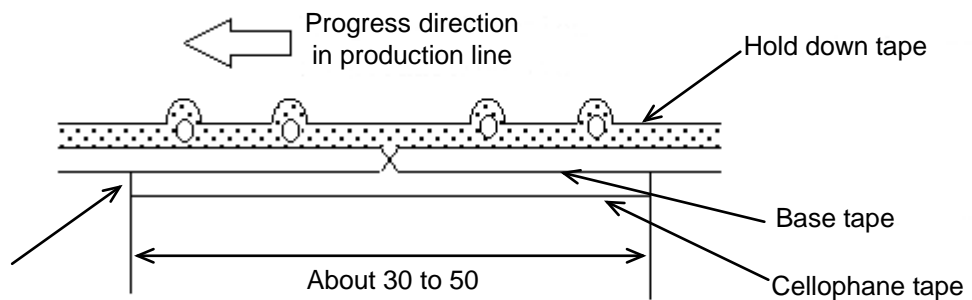

No lifting for the direction of progressing

Unit : mm

- b) When hold down tape is spliced

- Hold down tape shall be spliced with overlapping.  
(Total tape thickness shall be less than 1.05mm.)

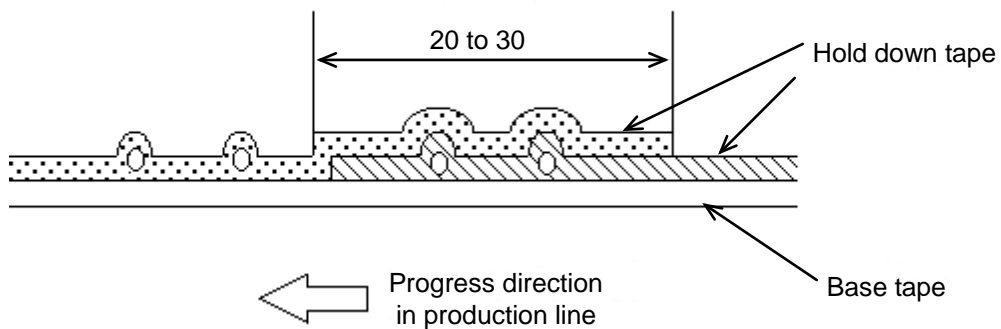

Unit : mm

- c) When both tape are spliced

- Base tape and hold down tape shall be spliced with splicing tape.

## EU RoHS and Halogen Free

This products of the following crresponds to EU RoHS and Halogen Free

### (1) RoHS

EU RoHs 2011/65/EC compliance

maximum concentration values tolerated by weight in homogeneous materials

- 1000 ppm maximum Lead
- 1000 ppm maximum Mercury
- 100 ppm maximum Cadmium
- 1000 ppm maximum Hexavalent chromium
- 1000 ppm maximum Polybrominated biphenyls (PBB)
- 1000 ppm maximum Polybrominated diphenyl ethers (PBDE)

### (2) Halogen-Free

The International Electrochemical Commission's (IEC) Definition of Halogen-Free (IEC 61249-2-21) compliance

- 900 ppm maximum chlorine
- 900 ppm maximum bromine
- 1500 ppm maximum total chlorine and bromine