

Schottky Rectifier, 2 x 15 A

VS-30CTQ...GSPbF

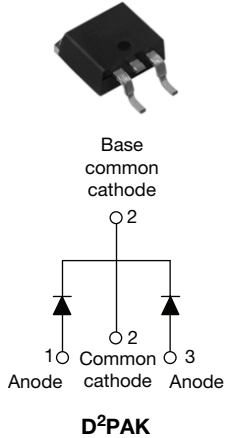

VS-30CTQ...G-1PbF

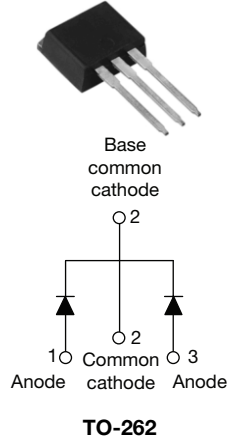

FEATURES

- 175 °C T_J operation
- Center tap configuration
- Low forward voltage drop
- High frequency operation
- High purity, high temperature epoxy encapsulation for enhanced mechanical strength and moisture resistance
- Guard ring for enhanced ruggedness and long term reliability
- Meets MSL level 1, per J-STD-020, LF maximum peak of 260 °C
- Halogen-free according to IEC 61249-2-21 definition
- Compliant to RoHS directive 2002/95/EC
- AEC-Q101 qualified



RoHS
COMPLIANT
HALOGEN
FREE

PRODUCT SUMMARY

| | |
|--------------------|------------|
| I _{F(AV)} | 2 x 15 A |
| V _R | 80 V/100 V |

DESCRIPTION

This center tap Schottky rectifier series has been optimized for low reverse leakage at high temperature. The proprietary barrier technology allows for reliable operation up to 175 °C junction temperature. Typical applications are in switching power supplies, converters, freewheeling diodes, and reverse battery protection.

MAJOR RATINGS AND CHARACTERISTICS

| SYMBOL | CHARACTERISTICS | VALUES | UNITS |
|--------------------|---|-------------|-------|
| I _{F(AV)} | Rectangular waveform | 30 | A |
| V _R | | 80/100 | V |
| I _{FSM} | t _p = 5 μs sine | 650 | A |
| V _F | 15 Apk, T _J = 125 °C (per leg) | 0.69 | V |
| T _J | Range | - 55 to 175 | °C |

VOLTAGE RATINGS

| PARAMETER | SYMBOL | VS-30CTQ080GSPbF VS-30CTQ080G-1PbF | VS-30CTQ100GSPbF VS-30CTQ100G-1PbF | UNITS |
|--------------------------------------|------------------|---------------------------------------|---------------------------------------|-------|
| Maximum DC reverse voltage | V _R | 80 | 100 | V |
| Maximum working peak reverse voltage | V _{RWM} | | | |

ABSOLUTE MAXIMUM RATINGS

| PARAMETER | SYMBOL | TEST CONDITIONS | VALUES | UNITS |
|---|--------------------|--|--|-------|
| Maximum average forward current See fig. 5 | I _{F(AV)} | 50 % duty cycle at T _C = 129 °C, rectangular waveform | per device | 30 |
| | | | per leg | 15 |
| Maximum peak one cycle non-repetitive surge current per leg See fig. 7 | I _{FSM} | 5 μs sine or 3 μs rect. pulse | Following any rated load condition and with rated V _R applied | 650 |
| | | 10 ms sine or 6 ms rect. pulse | | 210 |
| Non-repetitive avalanche energy per leg | E _{AS} | T _J = 25 °C, I _{AS} = 0.50 A, L = 60 mH | 7.50 | mJ |
| Repetitive avalanche current per leg | I _{AR} | Current decaying linearly to zero in 1 μs Frequency limited by T _J maximum V _A = 1.5 x V _R typical | 0.50 | A |

VS-30CTQ...GSPbF, VS-30CTQ...G-1PbF Series



Vishay High Power Products Schottky Rectifier, 2 x 15 A

| ELECTRICAL SPECIFICATIONS | | | | | |
|---|----------------|---|-----------------------------------|--------|------------------|
| PARAMETER | SYMBOL | TEST CONDITIONS | | VALUES | UNITS |
| Maximum forward voltage drop per leg See fig. 1 | $V_{FM}^{(1)}$ | 15 A | $T_J = 25\text{ }^\circ\text{C}$ | 0.86 | V |
| | | 30 A | | 1.05 | |
| | | 15 A | $T_J = 125\text{ }^\circ\text{C}$ | 0.69 | |
| | | 30 A | | 0.82 | |
| Maximum reverse leakage current per leg See fig. 2 | $I_{RM}^{(1)}$ | $T_J = 25\text{ }^\circ\text{C}$ | $V_R = \text{Rated } V_R$ | 0.28 | mA |
| | | $T_J = 125\text{ }^\circ\text{C}$ | | 7.0 | |
| Maximum junction capacitance per leg | C_T | $V_R = 5 V_{DC}$ (test signal range 100 kHz to 1 MHz), $25\text{ }^\circ\text{C}$ | | 500 | pF |
| Typical series inductance per leg | L_S | Measured lead to lead 5 mm from package body | | 8.0 | nH |
| Maximum voltage rate of change | dV/dt | Rated V_R | | 10 000 | V/ μs |

Note

(1) Pulse width < 300 μs , duty cycle < 2 %

| THERMAL - MECHANICAL SPECIFICATIONS | | | | | |
|--|----------------|--------------------------------------|--|-------------|------------------------|
| PARAMETER | SYMBOL | TEST CONDITIONS | | VALUES | UNITS |
| Maximum junction and storage temperature range | T_J, T_{Stg} | | | - 55 to 175 | $^\circ\text{C}$ |
| Maximum thermal resistance, junction to case per leg | R_{thJC} | DC operation | | 3.25 | $^\circ\text{C/W}$ |
| Maximum thermal resistance, junction to case per package | | | | 1.63 | |
| Typical thermal resistance, case to heatsink | R_{thCS} | Mounting surface, smooth and greased | | 0.50 | |
| Approximate weight | | | | 2 | g |
| | | | | 0.07 | oz. |
| Mounting torque | minimum | | | 6 (5) | kgf · cm (lbf · in) |
| | maximum | | | 12 (10) | |
| Marking device | | Case style D ² PAK | | 30CTQ080GS | |
| | | | | 30CTQ100GS | |
| | | Case style TO-262 | | 30CTQ080G-1 | |
| | | | | 30CTQ100G-1 | |



VS-30CTQ...GSPbF, VS-30CTQ...G-1PbF Series

Schottky Rectifier, 2 x 15 A Vishay High Power Products

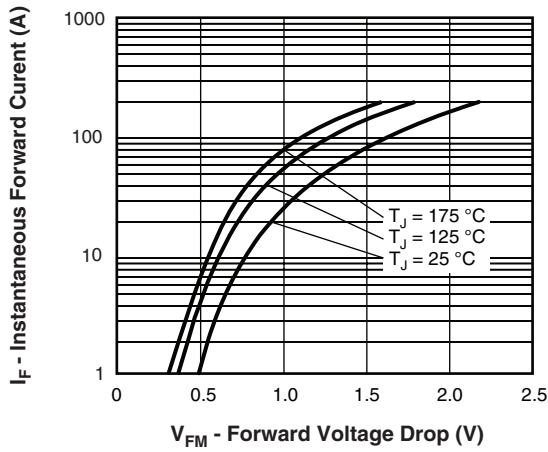

Fig. 1 - Maximum Forward Voltage Drop Characteristics (Per Leg)

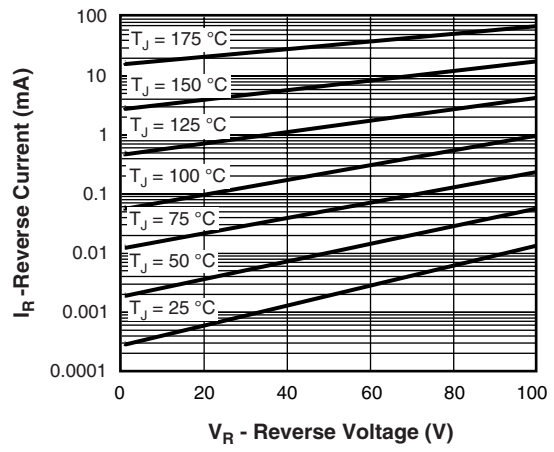

Fig. 2 - Typical Values of Reverse Current vs. Reverse Voltage (Per Leg)

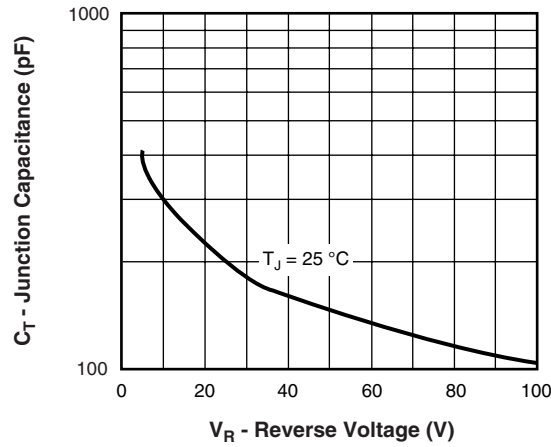

Fig. 3 - Typical Junction Capacitance vs. Reverse Voltage (Per Leg)

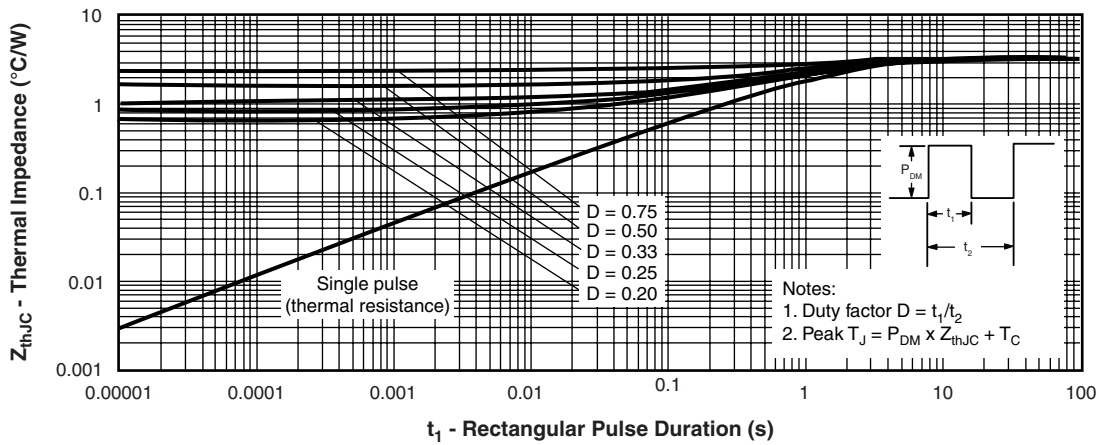

Fig. 4 - Maximum Thermal Impedance Z_{thJC} Characteristics (Per Leg)

VS-30CTQ...GSPbF, VS-30CTQ...G-1PbF Series



Vishay High Power Products Schottky Rectifier, 2 x 15 A

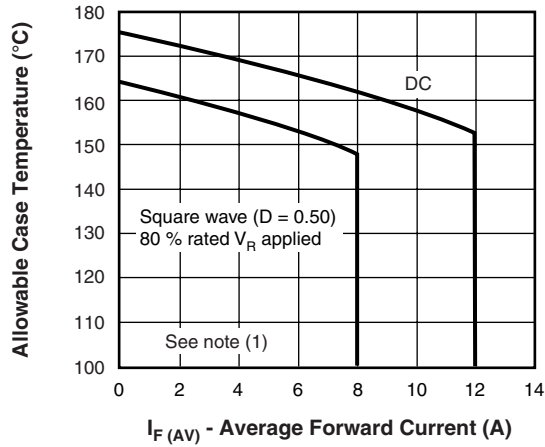

Fig. 5 - Maximum Allowable Case Temperature vs. Average Forward Current (Per Leg)

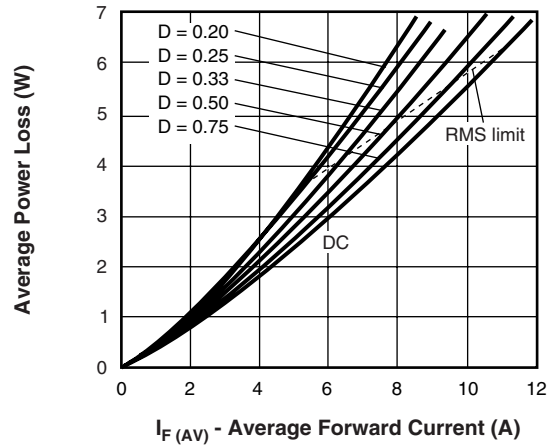

Fig. 6 - Forward Power Loss Characteristics (Per Leg)

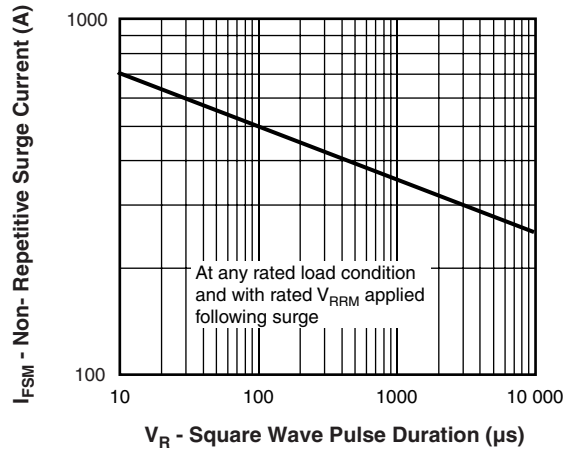

Fig. 7 - Maximum Non-Repetitive Surge Current (Per Leg)

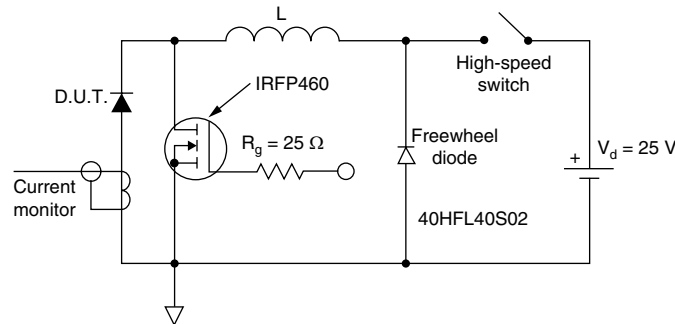

Fig. 8 - Unclamped Inductive Test Circuit

Note

- (1) Formula used: $T_C = T_J - (P_d + P_{d_{REV}}) \times R_{thJC}$;
 P_d = Forward power loss = $I_{F(AV)} \times V_{FM}$ at $(I_{F(AV)}/D)$ (see fig. 6);
 $P_{d_{REV}}$ = Inverse power loss = $V_{R1} \times I_R (1 - D)$; I_R at $V_{R1} = 10$ V



VS-30CTQ...GSPbF, VS-30CTQ...G-1PbF Series

Schottky Rectifier, 2 x 15 A Vishay High Power Products

ORDERING INFORMATION TABLE

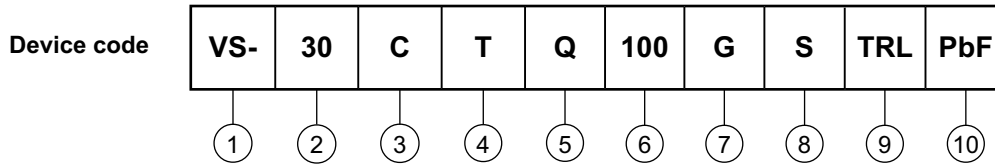

- 1** - HPP product suffix
- 2** - Current rating (30 = 30 A)
- 3** - C = Common cathode
- 4** - T = TO-220, TO-262, D²PAK
- 5** - Q = Schottky "Q" series
- 6** - Voltage ratings 080 = 80 V
100 = 100 V
- 7** - G = Schottky generation
- 8** -
 - -1 = TO-262
 - S = D²PAK
- 9** -
 - None = Tube (50 pieces)
 - TRL = Tape and reel (left oriented - for D²PAK only)
 - TRR = Tape and reel (right oriented - for D²PAK only)
- 10** -
 - PbF = Lead (Pb)-free (for D²PAK tube and TO-262)
 - P = Lead (Pb)-free (for D²PAK TRL and TRR)

| LINKS TO RELATED DOCUMENTS | |
|----------------------------|--|
| Dimensions | www.vishay.com/doc?95014 |
| Part marking information | www.vishay.com/doc?95008 |
| Packaging information | www.vishay.com/doc?95032 |

D²PAK, TO-262

DIMENSIONS FOR D²PAK in millimeters and inches

Conforms to JEDEC outline D²PAK (SMD-220)



| SYMBOL | MILLIMETERS | | INCHES | | NOTES |
|--------|-------------|-------|--------|-------|-------|
| | MIN. | MAX. | MIN. | MAX. | |
| A | 4.06 | 4.83 | 0.160 | 0.190 | |
| A1 | 0.00 | 0.254 | 0.000 | 0.010 | |
| b | 0.51 | 0.99 | 0.020 | 0.039 | |
| b1 | 0.51 | 0.89 | 0.020 | 0.035 | 4 |
| b2 | 1.14 | 1.78 | 0.045 | 0.070 | |
| b3 | 1.14 | 1.73 | 0.045 | 0.068 | 4 |
| c | 0.38 | 0.74 | 0.015 | 0.029 | |
| c1 | 0.38 | 0.58 | 0.015 | 0.023 | 4 |
| c2 | 1.14 | 1.65 | 0.045 | 0.065 | |
| D | 8.51 | 9.65 | 0.335 | 0.380 | 2 |

| SYMBOL | MILLIMETERS | | INCHES | | NOTES |
|--------|-------------|-------|-----------|-------|-------|
| | MIN. | MAX. | MIN. | MAX. | |
| D1 | 6.86 | 8.00 | 0.270 | 0.315 | 3 |
| E | 9.65 | 10.67 | 0.380 | 0.420 | 2, 3 |
| E1 | 7.90 | 8.80 | 0.311 | 0.346 | 3 |
| e | 2.54 BSC | | 0.100 BSC | | |
| H | 14.61 | 15.88 | 0.575 | 0.625 | |
| L | 1.78 | 2.79 | 0.070 | 0.110 | |
| L1 | - | 1.65 | - | 0.066 | 3 |
| L2 | 1.27 | 1.78 | 0.050 | 0.070 | |
| L3 | 0.25 BSC | | 0.010 BSC | | |
| L4 | 4.78 | 5.28 | 0.188 | 0.208 | |

Notes

- (1) Dimensioning and tolerancing per ASME Y14.5 M-1994
- (2) Dimension D and E do not include mold flash. Mold flash shall not exceed 0.127 mm (0.005") per side. These dimensions are measured at the outmost extremes of the plastic body
- (3) Thermal pad contour optional within dimension E, L1, D1 and E1
- (4) Dimension b1 and c1 apply to base metal only
- (5) Datum A and B to be determined at datum plane H
- (6) Controlling dimension: inch

- (7) Outline conforms to JEDEC outline TO-263AB

Outline Dimensions

Vishay High Power Products

D²PAK, TO-262



DIMENSIONS FOR TO-262 in millimeters and inches



| SYMBOL | MILLIMETERS | | INCHES | | NOTES |
|--------|-------------|-------|-----------|-------|-------|
| | MIN. | MAX. | MIN. | MAX. | |
| A | 4.06 | 4.83 | 0.160 | 0.190 | |
| A1 | 2.03 | 3.02 | 0.080 | 0.119 | |
| b | 0.51 | 0.99 | 0.020 | 0.039 | |
| b1 | 0.51 | 0.89 | 0.020 | 0.035 | 4 |
| b2 | 1.14 | 1.78 | 0.045 | 0.070 | |
| b3 | 1.14 | 1.73 | 0.045 | 0.068 | 4 |
| c | 0.38 | 0.74 | 0.015 | 0.029 | |
| c1 | 0.38 | 0.58 | 0.015 | 0.023 | 4 |
| c2 | 1.14 | 1.65 | 0.045 | 0.065 | |
| D | 8.51 | 9.65 | 0.335 | 0.380 | 2 |
| D1 | 6.86 | 8.00 | 0.270 | 0.315 | 3 |
| E | 9.65 | 10.67 | 0.380 | 0.420 | 2, 3 |
| E1 | 7.90 | 8.80 | 0.311 | 0.346 | 3 |
| e | 2.54 BSC | | 0.100 BSC | | |
| L | 13.46 | 14.10 | 0.530 | 0.555 | |
| L1 | - | 1.65 | - | 0.065 | 3 |
| L2 | 3.56 | 3.71 | 0.140 | 0.146 | |

Notes

- (1) Dimensioning and tolerancing as per ASME Y14.5M-1994
- (2) Dimension D and E do not include mold flash. Mold flash shall not exceed 0.127 mm (0.005") per side. These dimensions are measured at the outmost extremes of the plastic body
- (3) Thermal pad contour optional within dimension E, L1, D1 and E1
- (4) Dimension b1 and c1 apply to base metal only
- (5) Controlling dimension: inches
- (6) Outline conform to JEDEC TO-262 except A1 (maximum), b (minimum) and D1 (minimum) where dimensions derived the actual package outline



Disclaimer

ALL PRODUCT, PRODUCT SPECIFICATIONS AND DATA ARE SUBJECT TO CHANGE WITHOUT NOTICE TO IMPROVE RELIABILITY, FUNCTION OR DESIGN OR OTHERWISE.

Vishay Intertechnology, Inc., its affiliates, agents, and employees, and all persons acting on its or their behalf (collectively, "Vishay"), disclaim any and all liability for any errors, inaccuracies or incompleteness contained in any datasheet or in any other disclosure relating to any product.

Vishay makes no warranty, representation or guarantee regarding the suitability of the products for any particular purpose or the continuing production of any product. To the maximum extent permitted by applicable law, Vishay disclaims (i) any and all liability arising out of the application or use of any product, (ii) any and all liability, including without limitation special, consequential or incidental damages, and (iii) any and all implied warranties, including warranties of fitness for particular purpose, non-infringement and merchantability.

Statements regarding the suitability of products for certain types of applications are based on Vishay's knowledge of typical requirements that are often placed on Vishay products in generic applications. Such statements are not binding statements about the suitability of products for a particular application. It is the customer's responsibility to validate that a particular product with the properties described in the product specification is suitable for use in a particular application. Parameters provided in datasheets and/or specifications may vary in different applications and performance may vary over time. All operating parameters, including typical parameters, must be validated for each customer application by the customer's technical experts. Product specifications do not expand or otherwise modify Vishay's terms and conditions of purchase, including but not limited to the warranty expressed therein.

Except as expressly indicated in writing, Vishay products are not designed for use in medical, life-saving, or life-sustaining applications or for any other application in which the failure of the Vishay product could result in personal injury or death. Customers using or selling Vishay products not expressly indicated for use in such applications do so at their own risk. Please contact authorized Vishay personnel to obtain written terms and conditions regarding products designed for such applications.

No license, express or implied, by estoppel or otherwise, to any intellectual property rights is granted by this document or by any conduct of Vishay. Product names and markings noted herein may be trademarks of their respective owners.

Material Category Policy

Vishay Intertechnology, Inc. hereby certifies that all its products that are identified as RoHS-Compliant fulfill the definitions and restrictions defined under Directive 2011/65/EU of The European Parliament and of the Council of June 8, 2011 on the restriction of the use of certain hazardous substances in electrical and electronic equipment (EEE) - recast, unless otherwise specified as non-compliant.

Please note that some Vishay documentation may still make reference to RoHS Directive 2002/95/EC. We confirm that all the products identified as being compliant to Directive 2002/95/EC conform to Directive 2011/65/EU.

Vishay Intertechnology, Inc. hereby certifies that all its products that are identified as Halogen-Free follow Halogen-Free requirements as per JEDEC JS709A standards. Please note that some Vishay documentation may still make reference to the IEC 61249-2-21 definition. We confirm that all the products identified as being compliant to IEC 61249-2-21 conform to JEDEC JS709A standards.