

Intellimod™ Module Application Specific IPM 5 Amperes/1200 Volts

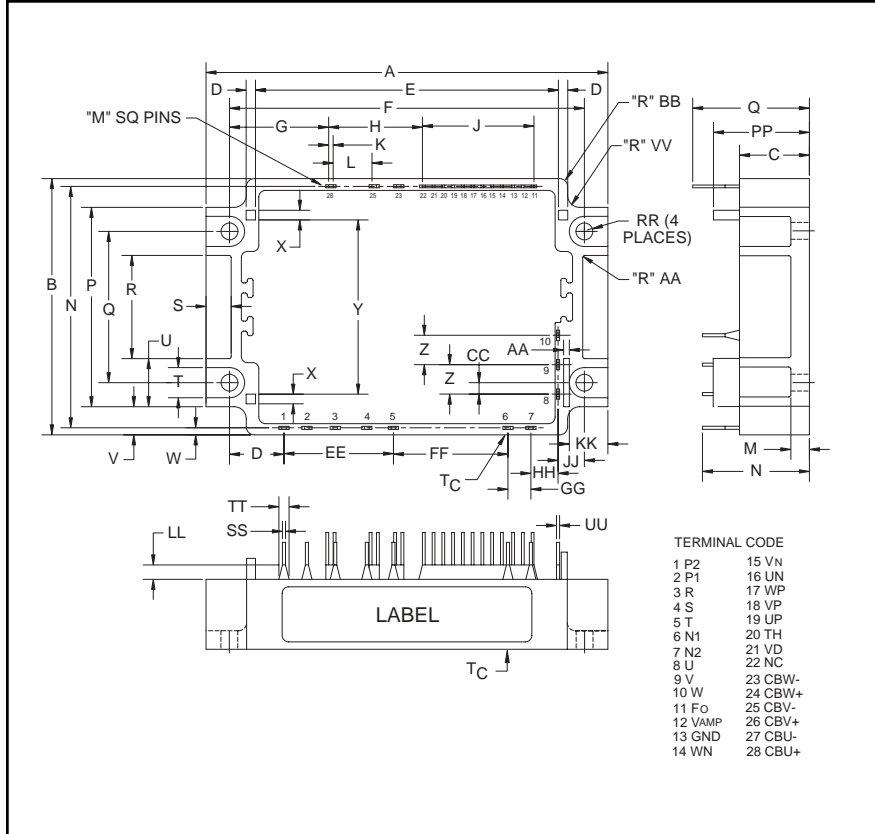

Outline Drawing and Circuit Diagram

Dimensions	Inches	Millimeters
A	4.06 +0/-0.02	103.0+0/-0.4
B	2.87 +0/-0.02	73.0 +0/-0.4
C	0.35	9.0
D	0.10	2.5
E	3.11	79.0
F	3.74±0.01	95±0.2
G	1.32	33.5
H	0.95	24.0
J	0.87	22.0
K	0.08	2.0
L	0.24	6.0
M	0.02 Sq.	0.5 Sq.
N	2.72	69.0
P	2.13	54.0
Q	1.54±0.01	39.0±0.2
R	0.95	24.0
S	0.26	6.5
T	0.35	9.0
U	0.59	15.0
V	0.37	9.5
W	0.08	2.0
X	0.12	3.0

Dimensions	Inches	Millimeters
Y	1.81	46.0
Z	0.30	7.62
AA	0.08 Rad.	2.0 Rad.
BB	0.04 Rad.	1.0 Rad.
CC	0.14	3.5
DD	0.47	12.0
EE	1.20	30.48
FF	0.90	22.86
GG	0.30	7.62
HH	0.51	13.4
JJ	0.35	9.0
KK	0.34	8.5
LL	0.08	2.0
MM	0.12	3.0
NN	0.67	17.0
PP	0.49	12.5
QQ	0.80	20.4
RR	0.16	4.0
SS	0.06	1.4
TT	0.12	3.0
UU	0.04	1.0
VV	0.16	4.0

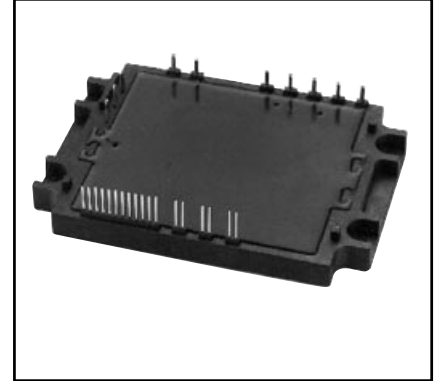

Description:

Powerex Application Specific IPMs (ASIPMs) are intelligent power modules that integrate power devices, gate drive and protection circuitry in a compact package for use in small inverter applications up to 20kHz. Use of application specific HVICs allow the designer to reduce inverter size and overall design time.

Features:

- Rectifier Bridge for 3-phase AC-to-DC Power Conversion
- 3-phase IGBT Inverter Bridge
- Integrated HVICs for Gate Drive, Protection and System Control Functions
- Built-in Thermistor
- Direct Connection to DSP/CPU

Applications:

- Smart Motors
- General Purpose Inverters
- Small Motor Control

Ordering Information:

PS12032 is a 1200V, 5 Ampere Application Specific Power Module.

PS12032
Intellimod™ Module
Application Specific IPM
 5 Amperes/1200 Volts

Absolute Maximum Ratings, $T_j = 25^\circ\text{C}$ unless otherwise specified

Characteristics	Symbol	PS12032	Units
Power Device Junction Temperature*	T_j	-20 to 125	$^\circ\text{C}$
Storage Temperature	T_{stg}	-40 to 125	$^\circ\text{C}$
Case Operating Temperature (See T_C Measure Point Illustration)	T_C	-20 to 100	$^\circ\text{C}$
Mounting Torque, M3.5 Mounting Screws	—	11.25	in-lb
Module Weight (Typical)	—	127	Grams
Isolation Voltage**	V_{ISO}	2500	Volts

*The indicated values are specified considering the safe operation of all the parts within the ASIPM. The maximum rating for the ASIPM power chips (IGBT & FWDI) is $T_j < 150$.

**60 Hz sinusoidal AC applied between all terminals and the base plate for 1 minute.

IGBT Inverter Sector

Supply Voltage (Applied between P2 - N2)	V_{CC}	900	Volts
Supply Voltage, Surge (Applied between P2 - N2, Surge-Value)	$V_{\text{CC(surge)}}$	1000	Volts
Each IGBT Collector-Emitter Static Voltage (Applied between P2-U·V·W, U·V·W-N2)	V_P or V_N	1200	Volts
Each IGBT Collector-Emitter Switching Voltage (Applied between P2-U·V·W, U·V·W-N2 (Pulse))	$V_{P(S)}$ or $V_{N(S)}$	1200	Volts
Each IGBT Collector Current, $T_C = 25^\circ\text{C}$, "()" means I_C Peak Value	$\pm I_C$ ($\pm I_{CP}$)	± 5 (± 10)	Amperes

Converter Sector

Repetitive Peak Reverse Voltage	V_{RRM}	1600	Volts
Recommended AC Input Voltage	E_a	440	Vrms
DC Output Current (3-phase Rectifying Circuit)	I_O	12	A
Surge (Non-repetitive) Forward Current (1 Cycle at 60Hz, Peak Value Non-repetitive)	I_{FSM}	120	A
I^2t for Fusing (Value for One Cycle of Surge Current)	I^2t	60	A^2s

Control Sector

Supply Voltage	V_D, V_{DB}	-0.5 ~ 20	Volts
Input Signal Voltage	V_{CIN}	-0.5 ~ 7.5	Volts
Fault Output Supply Voltage	V_{FO}	-0.5 ~ 7.5	Volts
Fault Output Current	I_{FO}	15	mA
DC-link IGBT Current Signal Amp Output Current	I_{AMP}	1	mA

PS12032
Intellimod™ Module
Application Specific IPM
 5 Amperes/1200 Volts

Electrical and Mechanical Characteristics, $T_j = 25^\circ\text{C}$ unless otherwise specified

Characteristics	Symbol	Test Conditions	Min.	Typ.	Max.	Units
IGBT Inverter Sector						
Collector-Emitter Saturation Voltage	$V_{CE(sat)}$	$I_C = 5\text{A}$, $T_j = 25^\circ\text{C}$, $V_D = V_{DB} = 15\text{V}$, Input = ON (Shunt Voltage Drop Not Included)	—	—	3.6	Volts
Diode Forward Voltage	V_{EC}	$T_j = 25^\circ\text{C}$, $-I_C = 5\text{A}$	—	—	3.5	Volts
Converter Diode Voltage	V_{FR}	$T_j = 25^\circ\text{C}$, $I_{FR} = 5\text{A}$	—	—	1.5	Volts
Converter Diode Reverse Current	I_{RRM}	$V_R = V_{RRM}$, $T_j = 125^\circ\text{C}$	—	—	8.0	mA
Switching Times	t_{on}	1/2 Bridge Inductive, Input = $5\text{V} \leftrightarrow 0\text{V}$,	0.3	1.2	2.0	μS
	$t_{C(on)}$	$V_{CC} = 600\text{V}$, $I_C = 5\text{A}$, $T_j = 125^\circ\text{C}$,	—	0.5	1.4	μS
	t_{off}	$V_D = 15\text{V}$, $V_{DB} = 15\text{V}$	—	2.2	4.0	μS
	$t_{C(off)}$	Note: t_{on} , t_{off} include delay time of the internal control circuit.	—	0.9	1.6	μS
FWDi Reverse Recovery Time	t_{rr}		—	0.2	—	μS
Short-circuit Endurance (Output, Arm, and Load Short-circuit Modes)		@ $V_{CC} \leq 800\text{V}$, Input = $5\text{V} \rightarrow 0\text{V}$ (One-shot), $-20^\circ\text{C} \leq T_{j(start)} \leq 125^\circ\text{C}$, $13.5\text{V} \leq V_D = V_{DB} \leq 16.5\text{V}$				<ul style="list-style-type: none"> • No Destruction • F_O Output by Protection Operation
Switching SOA		@ $V_{CC} \leq 800\text{V}$, Input = $5\text{V} \rightarrow 0\text{V}$, $T_j \leq 150^\circ\text{C}$, $I_C < \text{OC Trip Level}$, $13.5\text{V} \leq V_D = V_{DB} \leq 16.5\text{V}$				<ul style="list-style-type: none"> • No Destruction • No Protecting Operation • No F_O Output

T_C Measure Point

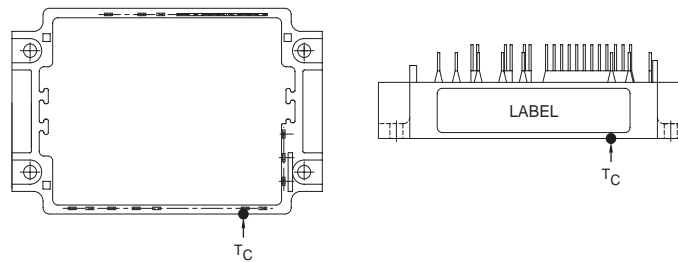

PS12032
Intellimod™ Module
Application Specific IPM
 5 Amperes/1200 Volts

Electrical and Mechanical Characteristics, $T_j = 25^\circ\text{C}$ unless otherwise specified

Characteristics	Symbol	Test Conditions	Min.	Typ.	Max.	Units
Control Sector						
Circuit Current (Average)	I_D	$T_j = 25^\circ\text{C}, V_D = 15\text{V}, V_{IN} = 5\text{V}$	—	—	50	mA
	I_{DB}	$T_j = 25^\circ\text{C}, V_D = V_{DB} = 15\text{V}, V_{IN} = 5\text{V}$	—	—	5	mA
Input ON Threshold Voltage	$V_{th(on)}$		0.8	1.4	2.0	Volts
Input OFF Threshold Voltage	$V_{th(off)}$		2.5	3.0	4.0	Volts
Input Pull-up Resistor	R_i	Applied between Input Terminal-inside Power Supply	—	50	—	$k\Omega$
PWM Input Frequency	f_{PWM}	$T_C \leq 100^\circ\text{C}, T_j \leq 125^\circ\text{C}$	—	10	15	kHz
Arm Shoot-through Blocking Time*	t_{DEAD}	Relates to Corresponding Inputs $T_C = -20^\circ\text{C} \sim 100^\circ\text{C}$	4.0	—	—	μs
Input Interlock Sensing	t_{int}	Relates to Corresponding Input	—	100	—	ns
Inverter DC-link IGBT Current	$V_{amp} 100\%$	$I_C = I_{OP(100\%)}, V_D = 15\text{V}, T_j = 25^\circ\text{C}$	1.5	2.0	2.5	Volts
Sense Voltage Output Signal**	$V_{amp} 200\%$	$I_C = I_{OP(200\%)}, V_D = 15\text{V}, T_j = 25^\circ\text{C}$	3.0	4.0	5.0	Volts
Inverter DC-link IGBT Current	$V_{amp} 250\%$	$I_C = I_{OP(250\%)}, V_D = 15\text{V}$	5.0	—	—	Volts
Sense Voltage Output Limit**	$V_{amp} 0\%$	$I_C = I_{OP(0\%)}, V_D = 15\text{V}$	—	50	100	mV
Over-current Trip Level	OC		5.5	7.0	—	Amperes
Over-current Delay Time	t_{OC}	$T_j = 25^\circ\text{C}$	—	10	—	μs
Short-circuit Trip Level	SC		—	11.0	—	Amperes
Short-circuit Delay Time	t_{SC}		—	2	—	μs
Supply Circuit	Trip Level	UV_D	11.0	12.0	12.75	Volts
	Reset Level	UV_{Dr}	11.5	12.5	13.25	Volts
Under-voltage Protection	Trip Level	UV_{DB}	10.1	10.8	11.6	Volts
	Reset Level	UV_{DBr}	10.6	11.3	12.1	Volts
	Delay Time	t_{dV}	—	10	—	μs
Fault Output Pulse Width***	t_{FO}	$T_j = 25^\circ\text{C}$	1.0	1.8	—	mS
Fault Output Current***	$I_{FO(H)}$	Open Collector Output	—	—	1	μA
	$I_{FO(L)}$		—	—	15	mA
Thermistor Resistance	R_{TO}	$T_O = 25^\circ\text{C} (298\text{K})$	9.5	10	10.5	$k\Omega$
Material Constant****	β	$T_1 = 25^\circ\text{C}, T_2 = 50^\circ\text{C}$	—	3450	—	K

* The dead-time has to be set externally by the CPU; it is not part of the ASIPM internal functions.

**Refer to the graph on next page.

***Fault output signalling is given only when the internal OC, SC, and UV protection circuits are activated. The OC, SC and UV protection (and fault output) operate for the lower arms only. The OC and SC protection fault output is given in a pulse format while that of UV protection is maintained throughout the duration of the under-voltage condition.

$$****T = \frac{1}{\frac{1}{\beta} \cdot \ln \left[\frac{R_T}{R_{TO}} \right] + \frac{1}{T_O}}$$

PS12032
Intellimod™ Module
Application Specific IPM
 5 Amperes/1200 Volts

Thermal Characteristics

Characteristic	Symbol	Condition	Min.	Typ.	Max.	Units
Junction to Case	$R_{th(j-c)Q}$	Each IGBT	—	—	2.5	°C/Watt
	$R_{th(j-c)D}$	Each FWDi	—	—	4.5	°C/Watt
	$R_{th(j-c)FR}$	Each Converter	—	—	2.5	°C/Watt
Contact Thermal Resistance	$R_{th(c-f)}$	Case to Fin Per Module. Thermal Grease Applied	—	—	0.05	°C/Watt

Recommended Conditions for Use

Characteristic	Symbol	Condition	Min.	Typ.	Value	Units
Supply Voltage	V_{CC}	Applied across P2-N2 Terminals	—	600	800	Volts
Control Supply Voltage	V_D	Applied between V_D -GND	13.5	15.0	16.5	Volts
	V_{DB}	Applied between CBU+ & CBU-, CBV+ & CBV-, CBW+ & CBW-	13.5	15.0	16.5	Volts
Control Supply dv/dt	$dV_D/dt, dV_{DB}/dt$		-1	—	1	V/ μ s
Input ON Voltage	$V_{CIN(on)}$	Applied between	0	—	0.8	Volts
Input OFF Voltage	$V_{CIN(off)}$	$U_P, V_P, W_P, U_N, V_N, W_N$ -GND	4.0	—	5.0	Volts
Module Case Operating Temperature	T_C		—	—	100	°C
PWM Input Frequency	f_{PWM}	$T_C \leq 100^\circ\text{C}, T_J \leq 125^\circ\text{C}$	—	—	15	kHz
Allowable Minimum Input On-pulse Width	t_{XX}		1	—	—	μ s
Arm Shoot-through Blocking Time	t_{DEAD}	Relate to Corresponding Inputs	4.0	—	—	μ s

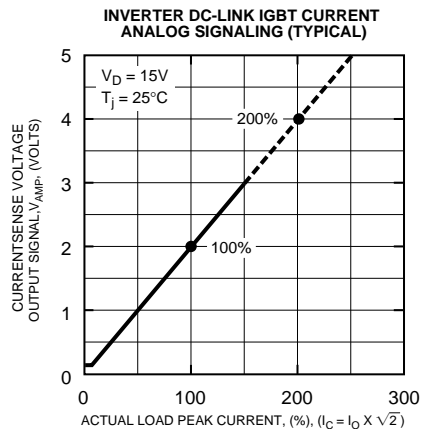

PS12032
Intellimod™ Module
Application Specific IPM
 5 Amperes/1200 Volts

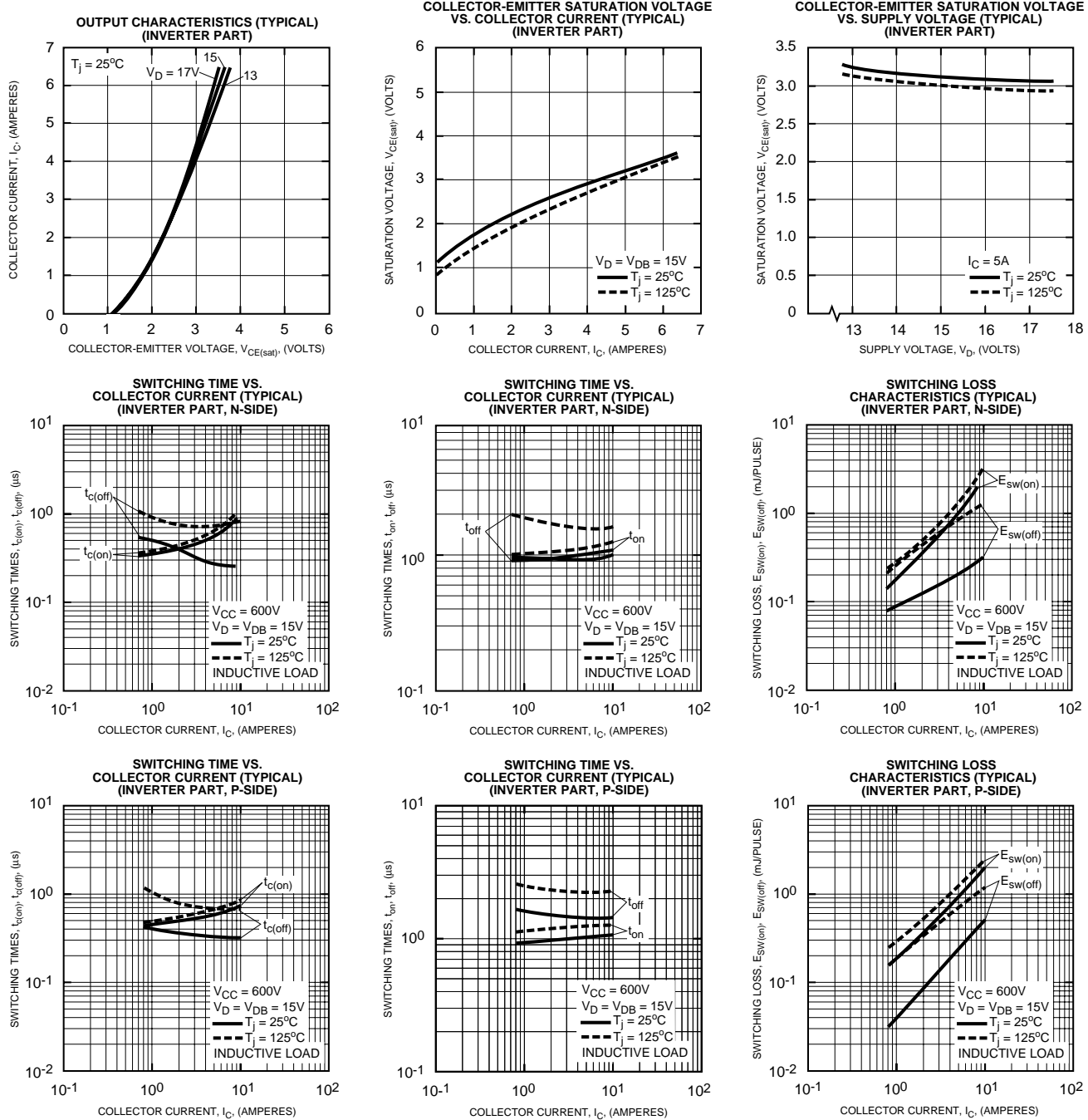

PS12032
Intellimod™ Module
Application Specific IPM
5 Amperes/1200 Volts

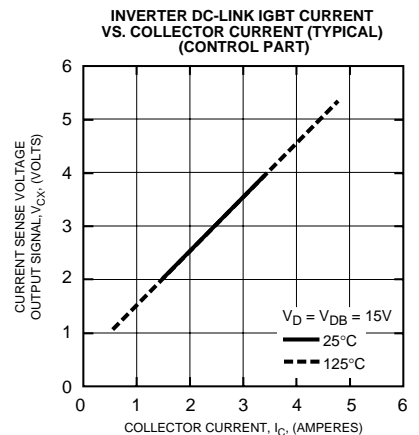
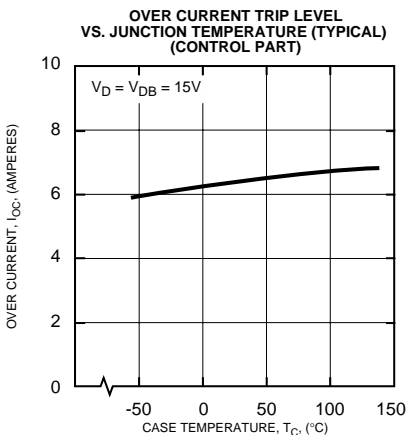
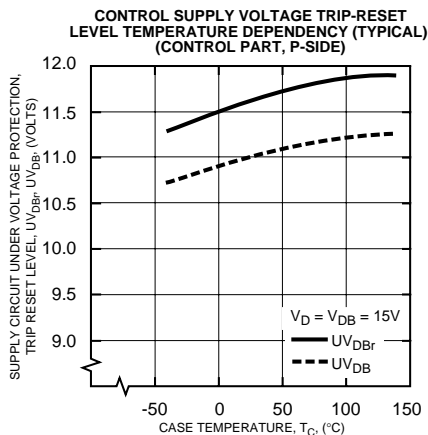
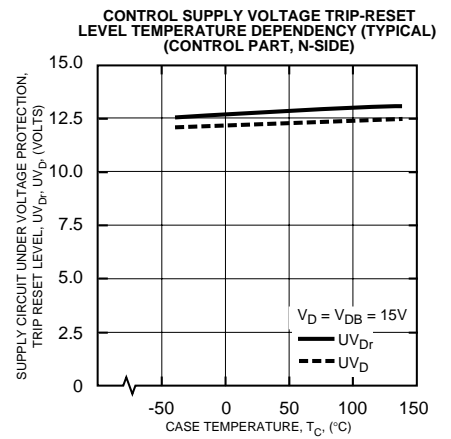
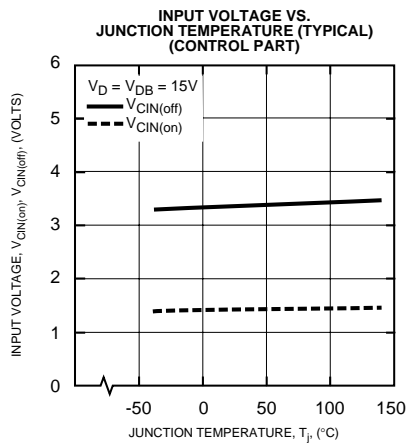
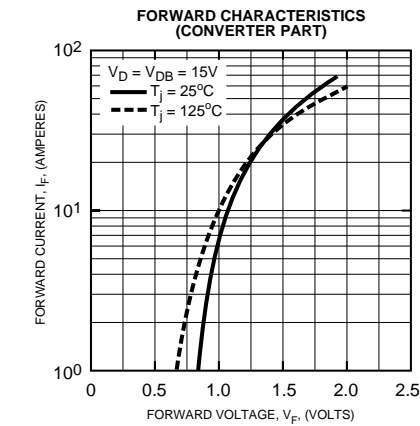
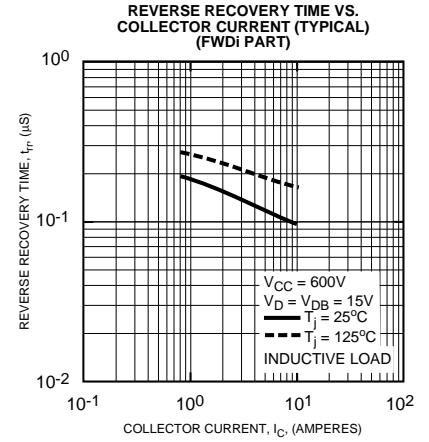
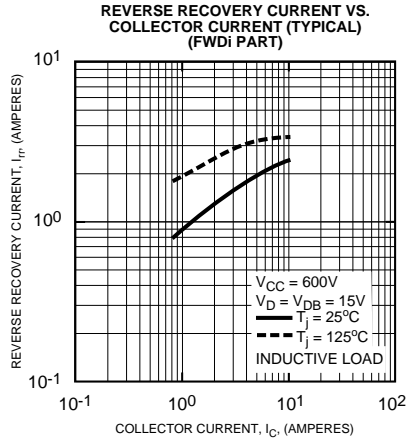
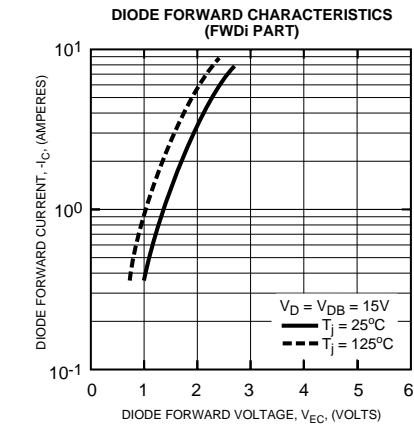

PS12032
Intellimod™ Module
Application Specific IPM
 5 Amperes/1200 Volts

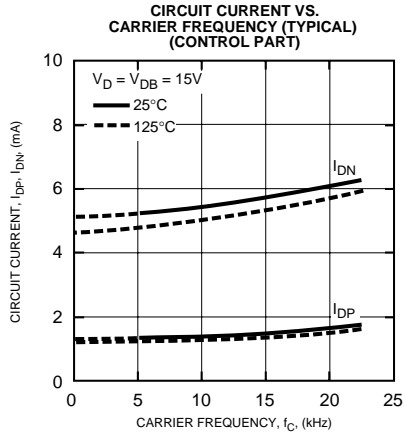

Functional Block Diagram

