

Core **Toroid 25/15/10**

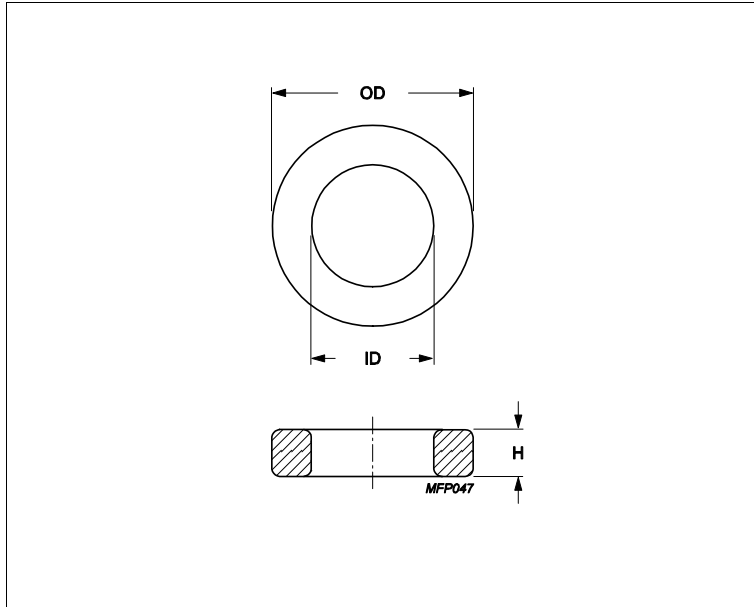

Effective parameters			
	Parameter	Value	Unit
$\Sigma(I/A)$	core factor (C1)	1.23	mm ⁻¹
Ve	effective volume	2944	mm ³
Le	effective length	60.2	mm
Ae	effective area	48.9	mm ²
m	mass of core	≈ 15	g/pcs

Epoxy coating DC isolation voltage 2000.

Maximum operating temperature of the coating is 200°C.

Dimensions (mm)

Cores	OD	ID	H	
TX25/15/10	25.95 max	14.15 min	10.9 max	Epoxy Coated

Core data

Cores	Material	Al (nH/turns ²)	Al tolerance	μe
TX25/15/10	3C94	2350	± 25%	≈ 2300
TX25/15/10	3E10	10200	± 20%	≈ 10000
TX25/15/10	3E12	12300	± 30%	≈ 12000
TX25/15/10	3E27	5620	± 25%	≈ 5500
TX25/15/10	3E6 (3E10-M)	10200	± 30%	≈ 10000
TX25/15/10	3E65	5310	± 25%	≈ 5200