

OLIVIA-S

~20° spot beam

TECHNICAL SPECIFICATIONS:

Dimensions	Ø 70 mm
Height	22.6 mm
Fastening	screw
Colour	clear
Box size	
Box weight	0 kg
Quantity in Box	pcs
ROHS compliant	yes ⓘ



MATERIAL SPECIFICATIONS:



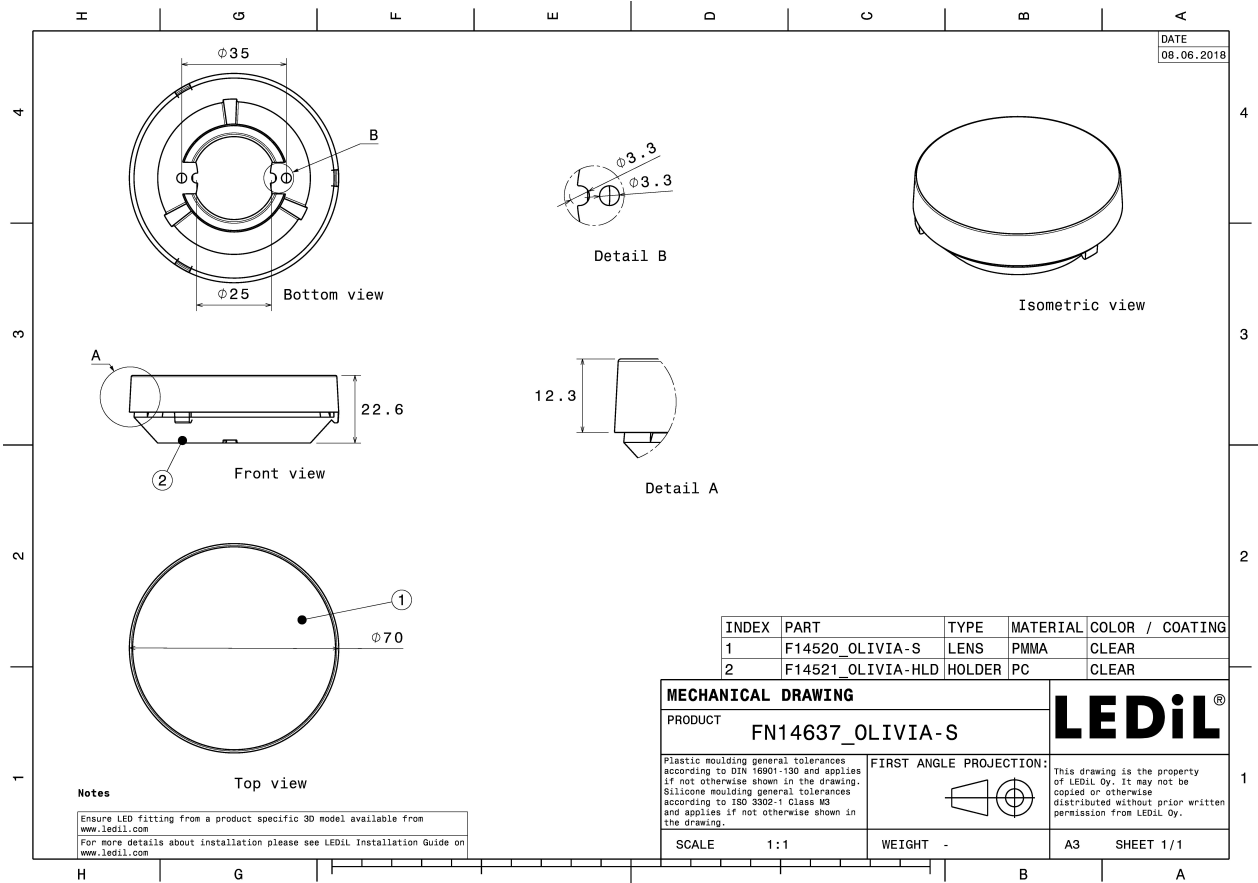



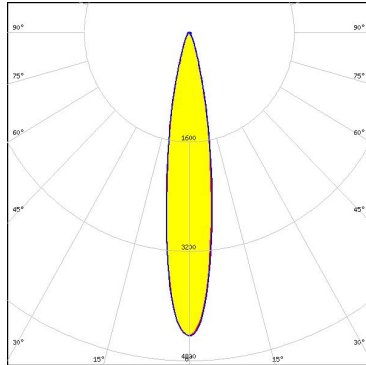
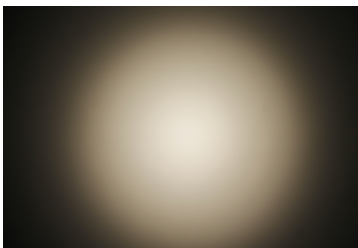
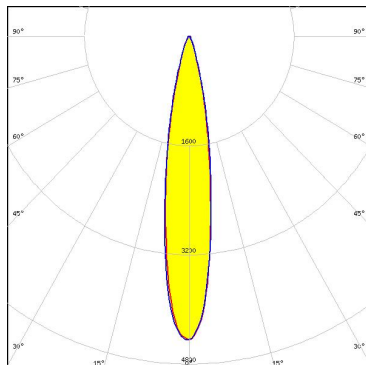
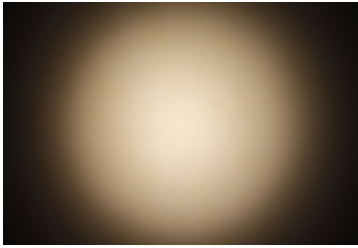
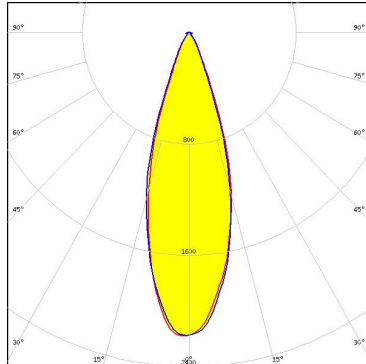
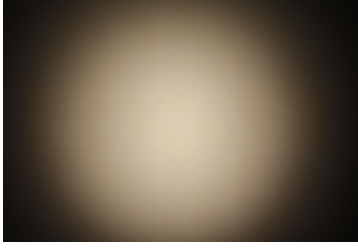
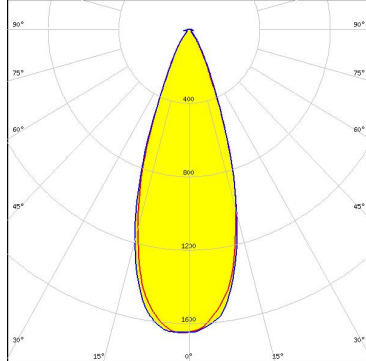

Component	Type	Material	Colour
OLIVIA-S	Lens	PC	clear
OLIVIA-HLD	Holder	PC	clear

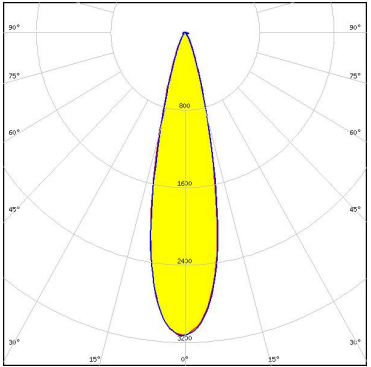

PHOTOMETRIC DATA (MEASURED):

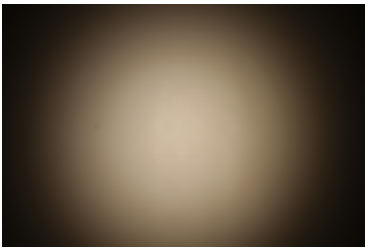
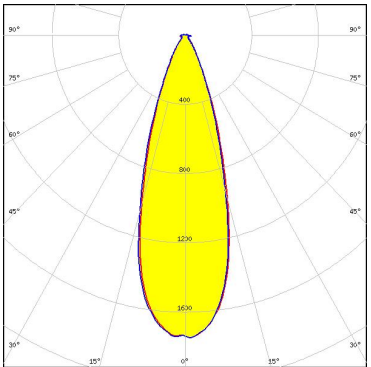
<p>bridgelux.</p> <p>LED V10 Gen6 FWHM 18.0° Efficiency 75 % Peak intensity 4.400 cd/lm Required components: BJB: 47.319.6214</p>		
<p>bridgelux.</p> <p>LED V10 Gen7 FWHM 18.0° Efficiency 75 % Peak intensity 4.500 cd/lm Required components: BJB: 47.319.6060</p>		
<p>bridgelux.</p> <p>LED V15 Gen6 FWHM 32.0° Efficiency 79 % Peak intensity 2.200 cd/lm Required components:</p>		
<p>bridgelux.</p> <p>LED V18 Gen6 FWHM 37.0° Efficiency 78 % Peak intensity 1.700 cd/lm Required components:</p>		

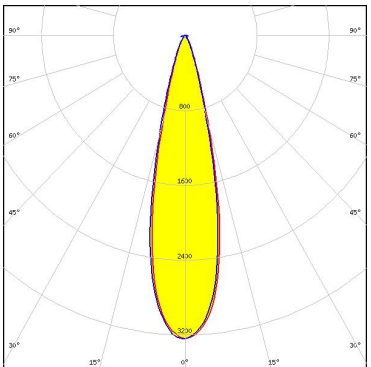
PHOTOMETRIC DATA (MEASURED):

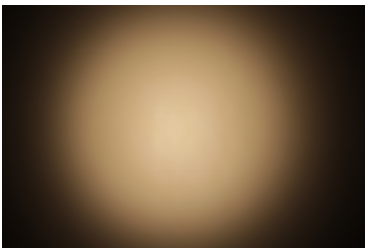
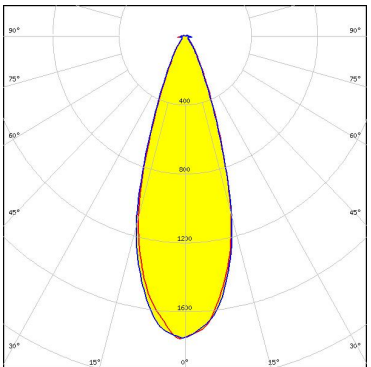
 LED Vero SE 13 FWHM 24.0° Efficiency 77 % Peak intensity 3.100 cd/lm Required components:		
 LED Vero SE 18 FWHM 33.0° Efficiency 76 % Peak intensity 1.800 cd/lm Required components:		
 LED Xenio Point 13mm FWHM 25.0° Efficiency 80 % Peak intensity 3.240 cd/lm Required components:		
 LED Xenio Point 18mm FWHM 35.0° Efficiency 79 % Peak intensity 1.760 cd/lm Required components:		

PHOTOMETRIC DATA (MEASURED):

CITIZEN

LED CLL03x/CLU03x
 FWHM 23.0°
 Efficiency 76 %
 Peak intensity 2.700 cd/lm
 Required components:
 A.A.G. STUCCHI: 8101/G2

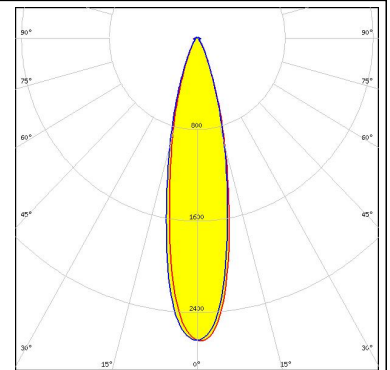
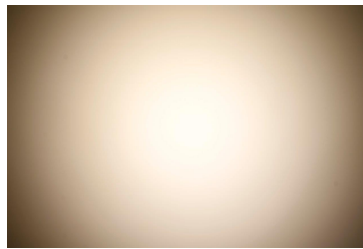

CITIZEN

LED CLL03x/CLU03x
 FWHM 26.0°
 Efficiency 76 %
 Peak intensity 2.400 cd/lm
 Required components:
 A.A.G. STUCCHI: 8101/G2

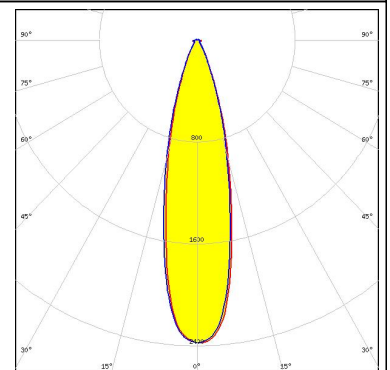
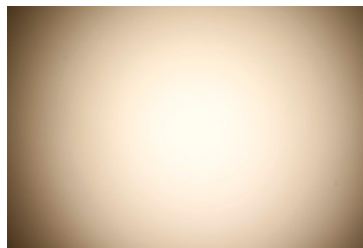

CITIZEN

LED CLU700/701
 FWHM 19.0°
 Efficiency 74 %
 Peak intensity 4.400 cd/lm
 Required components:
 BJB: 47.319.6060

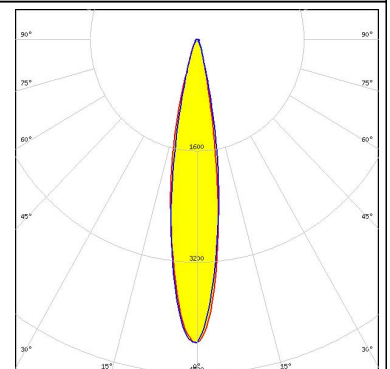
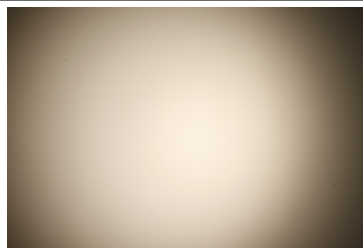

CITIZEN

LED CLU700/701
 FWHM 14.0°
 Efficiency 75 %
 Peak intensity 7.000 cd/lm
 Required components:
 A.A.G. STUCCHI: 8100/G2

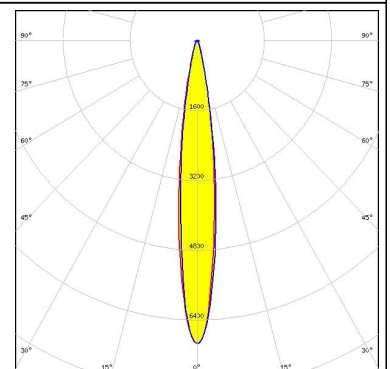
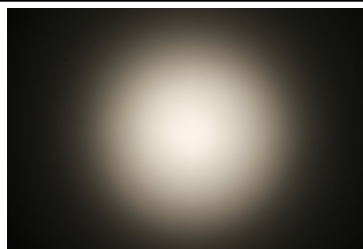

PHOTOMETRIC DATA (MEASURED):

CITIZEN

LED CLU720/721
FWHM 21.0°
Efficiency 74 %
Peak intensity 3.200 cd/lm
Required components:
BJB: 47.319.2021

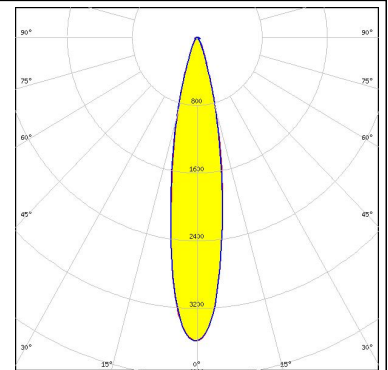
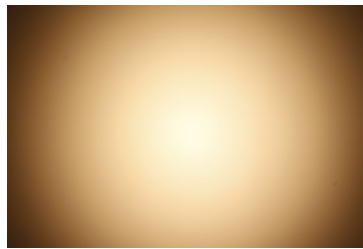

CITIZEN

LED CLU720/721
FWHM 20.0°
Efficiency 74 %
Peak intensity 3.300 cd/lm
Required components:
TE: 2213254-2

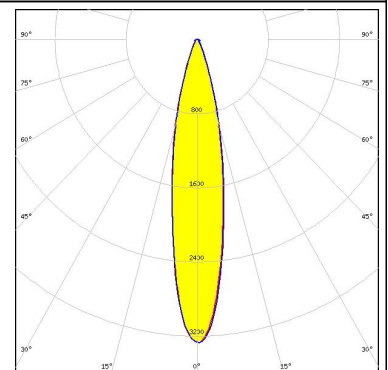
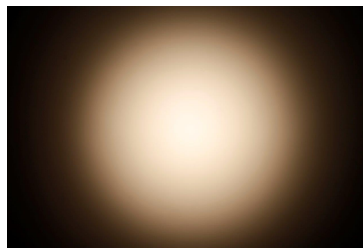

CITIZEN

LED CLU720/721
FWHM 20.0°
Efficiency 76 %
Peak intensity 3.600 cd/lm
Required components:
A.A.G. STUCCHI: 8101/G2

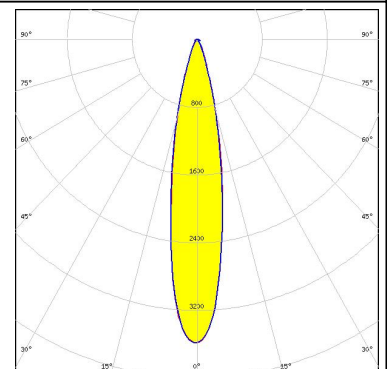
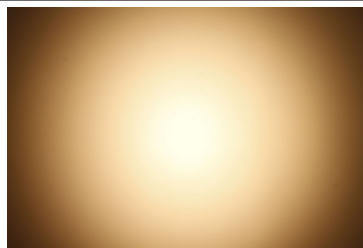

CREE 

LED CXA/B 13xx
FWHM 14.0°
Efficiency 74 %
Peak intensity 7.000 cd/lm
Required components:
BJB: 47.319.6120

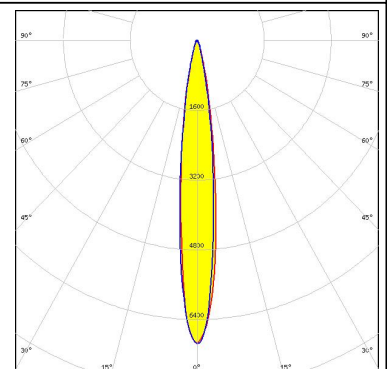

PHOTOMETRIC DATA (MEASURED):



LED CXA/B 1816 & CXA/B 1820 & CXA 1850
 FWHM 21.0°
 Efficiency 76 %
 Peak intensity 3.300 cd/lm
 Required components:
 BJB: 47.319.2131

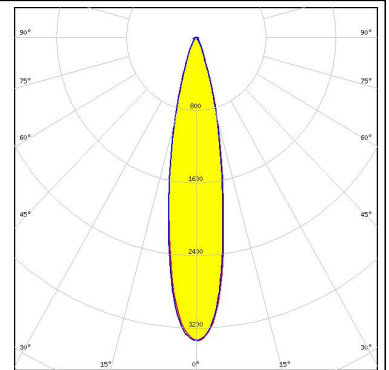

LED CXA/B 25xx
 FWHM 29.0°
 Efficiency 73 %
 Peak intensity 1.600 cd/lm
 Required components:
 TE: 2213407-2

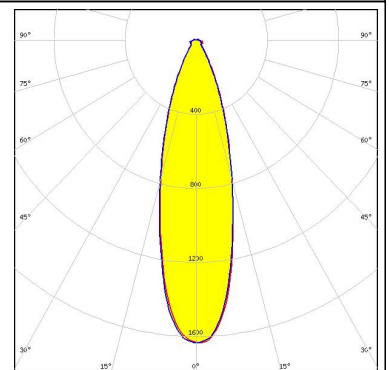
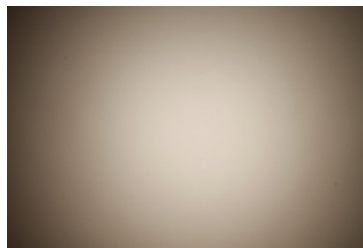

LED CXA/B 25xx
 FWHM 29.0°
 Efficiency 74 %
 Peak intensity 1.700 cd/lm
 Required components:
 A.A.G. STUCCHI: 8401/G2

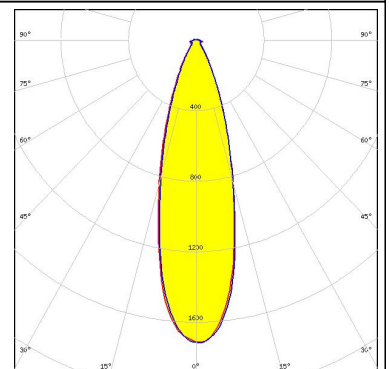
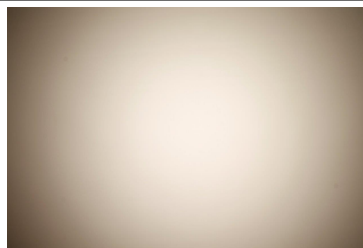

LED CXA/B 25xx
 FWHM 29.0°
 Efficiency 74 %
 Peak intensity 1.700 cd/lm
 Required components:
 BJB: 47.319.2040

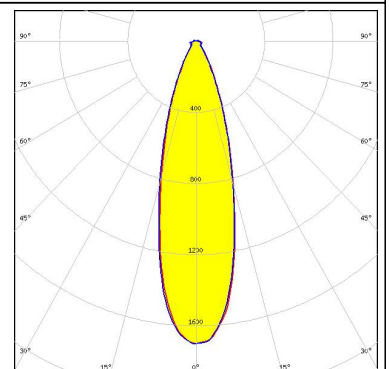
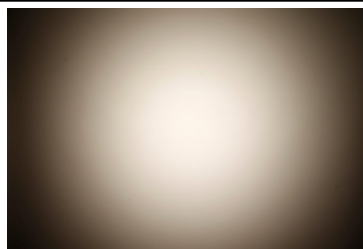

PHOTOMETRIC DATA (MEASURED):

LUMILEDS

LED LUXEON CoB 1204/1205
 FWHM 26.0°
 Efficiency 77 %
 Peak intensity 3.100 cd/lm
 Required components:
 Bender Wirth: 432 Typ Z1

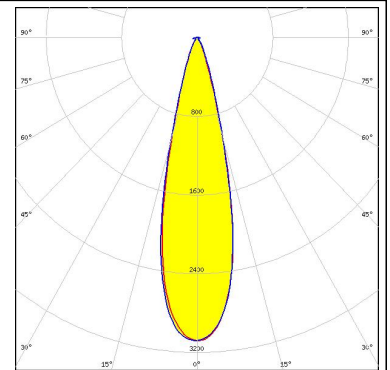
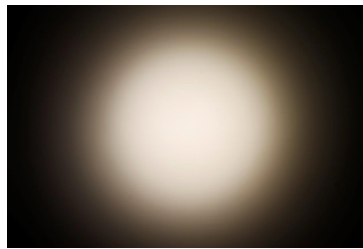

LUMILEDS

LED LUXEON CoB 1204/1205
 FWHM 23.0°
 Efficiency 76 %
 Peak intensity 2.800 cd/lm
 Required components:
 A.A.G. STUCCHI: 8301/G2

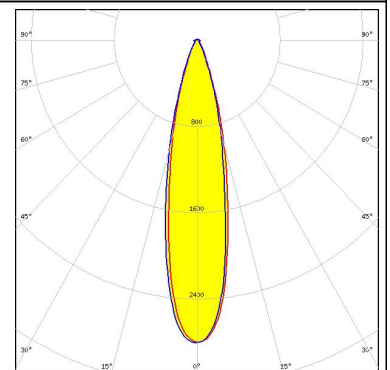
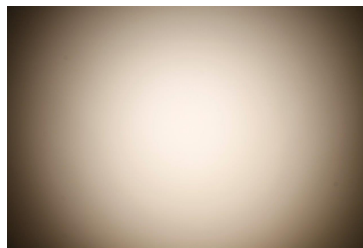

LUMILEDS

LED LUXEON CoB 1208
 FWHM 29.0°
 Efficiency 77 %
 Peak intensity 2.400 cd/lm
 Required components:
 Bender Wirth: 432 Typ Z1

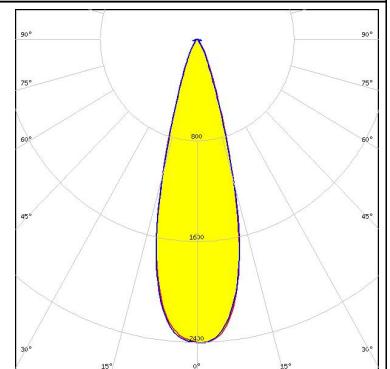
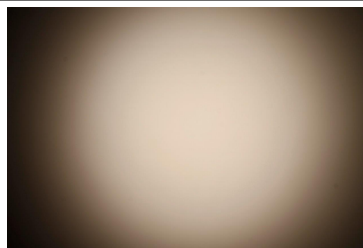

LUMILEDS

LED LUXEON CoB 1211
 FWHM 32.0°
 Efficiency 73 %
 Peak intensity 1.480 cd/lm
 Required components:
 BJB: 47.319.2030

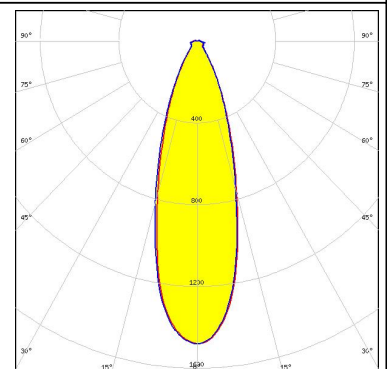
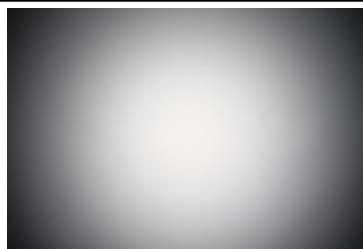

PHOTOMETRIC DATA (MEASURED):

LUMILEDS

LED LUXEON CoB 1216/1812
 FWHM 37.0°
 Efficiency 71 %
 Peak intensity 1.080 cd/lm
 Required components:
 BJB: 47.319.2030

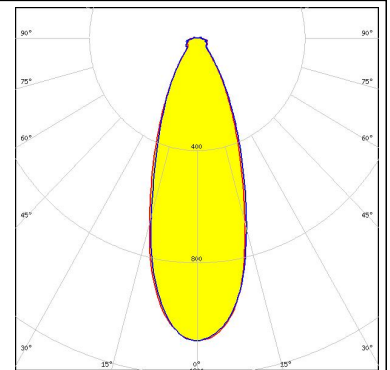
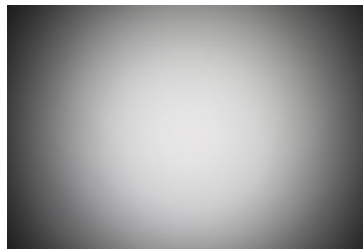

LUMILEDS

LED LUXEON CoB Compact
 FWHM 15.0°
 Efficiency 75 %
 Peak intensity 6.100 cd/lm
 Required components:
 BJB: 47.319.6180

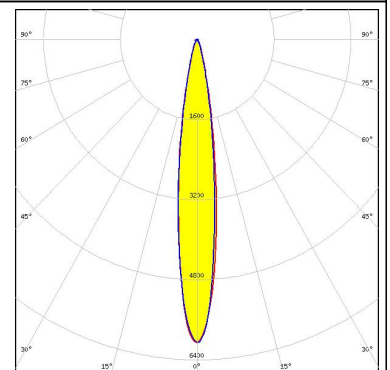
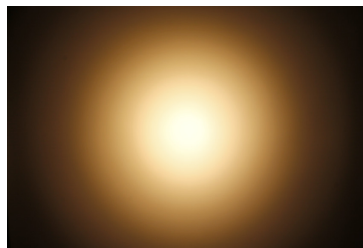

PHILIPS

LED Fortimo SLM L09 Poke-In
 FWHM 18.0°
 Efficiency 78 %
 Peak intensity 4.950 cd/lm
 Required components:

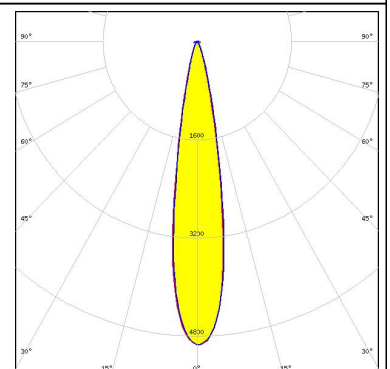
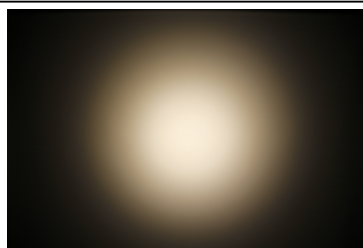

PHILIPS

LED Fortimo SLM L13 Poke-In
 FWHM 25.0°
 Efficiency 76 %
 Peak intensity 2.820 cd/lm
 Required components:

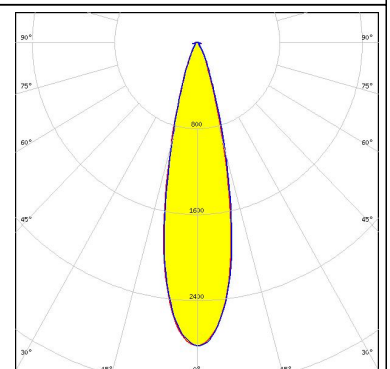
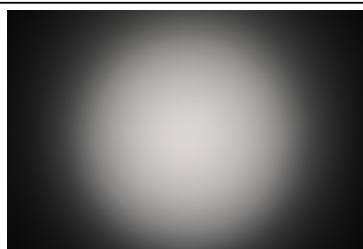

PHOTOMETRIC DATA (MEASURED):

PHILIPS

LED Fortimo SLM L15 Poke-In
FWHM 28.0°
Efficiency 76 %
Peak intensity 2.230 cd/lm
Required components:

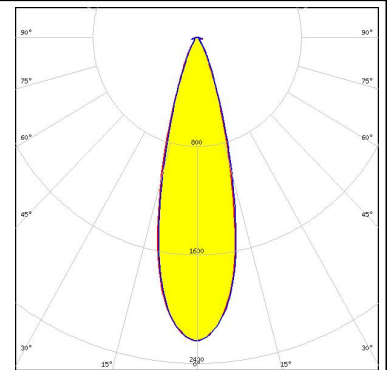

PHILIPS

LED Fortimo SLM L19 Poke-In
FWHM 35.0°
Efficiency 75 %
Peak intensity 1.500 cd/lm
Required components:

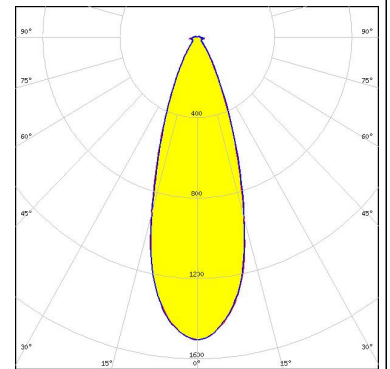
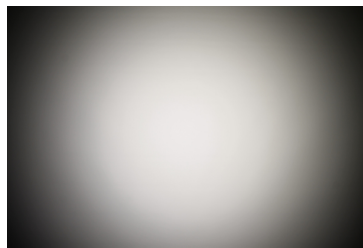

SAMSUNG

LED COB D Series LES 14.5 mm
FWHM 26.0°
Efficiency 76 %
Peak intensity 2.220 cd/lm
Required components:
A.A.G. STUCCHI: 8101/G2

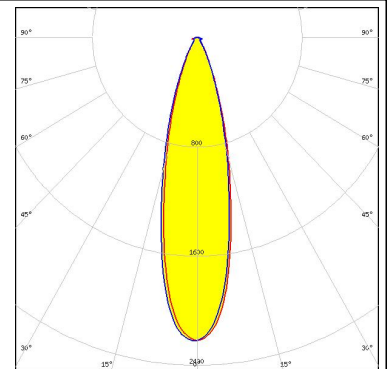
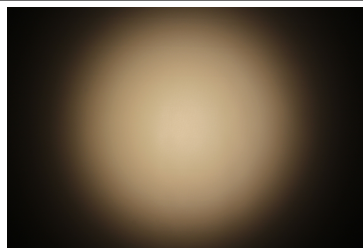

SAMSUNG

LED COB D Series LES 14.5 mm
FWHM 26.0°
Efficiency 76 %
Peak intensity 2.220 cd/lm
Required components:
BJB: 47.319.2021

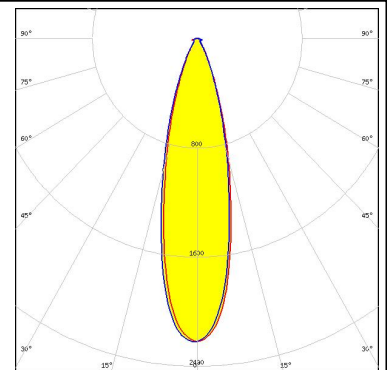
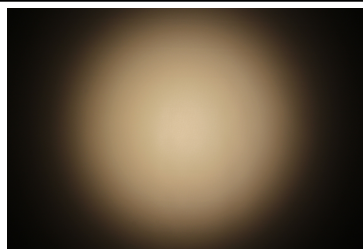

PHOTOMETRIC DATA (MEASURED):

SAMSUNG

LED COB D Series LES 9.8 mm
 FWHM 18.0°
 Efficiency 77 %
 Peak intensity 4.400 cd/lm
 Required components:
 BJB: 47.319.6060

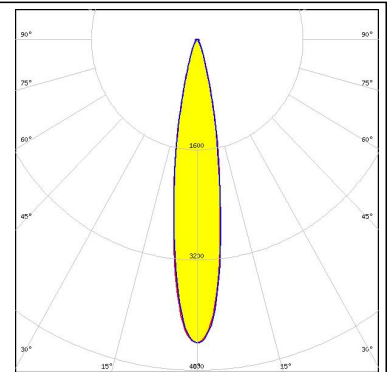

SAMSUNG

LED COB D Series LES 9.8 mm
 FWHM 18.0°
 Efficiency 77 %
 Peak intensity 4.400 cd/lm
 Required components:
 A.A.G. STUCCHI: 8100/G2

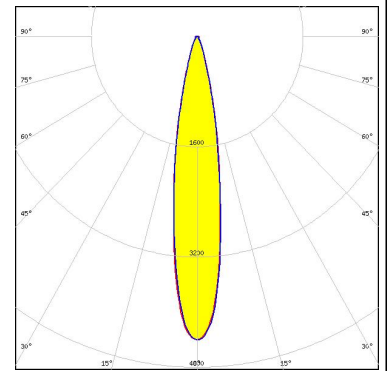
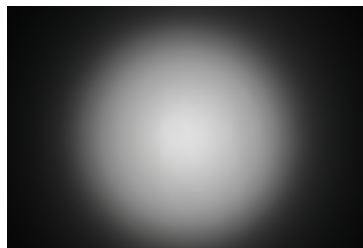

SAMSUNG

LED SLE-013
 FWHM 21.0°
 Efficiency 75 %
 Peak intensity 3.100 cd/lm
 Required components:

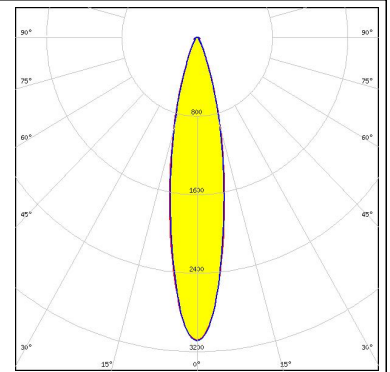
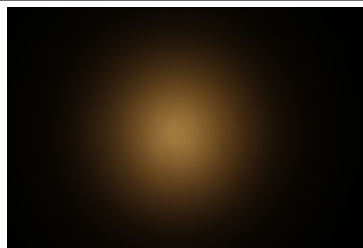

SAMSUNG

LED SLE-026/033/040
 FWHM 29.0°
 Efficiency 74 %
 Peak intensity 1.740 cd/lm
 Required components:

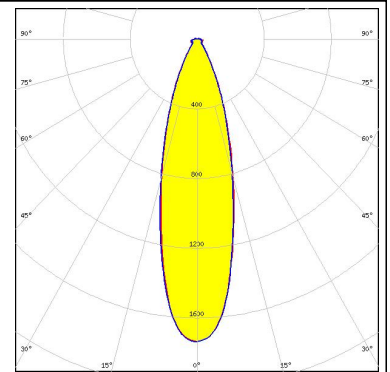
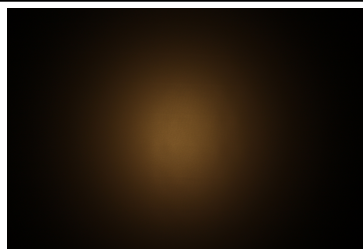

PHOTOMETRIC DATA (MEASURED):

SHARP

LED Mini Zenigata (GW6BM)
FWHM 17.0°
Efficiency 75 %
Peak intensity 4.800 cd/lm
Required components:
BJB: 47.319.6180

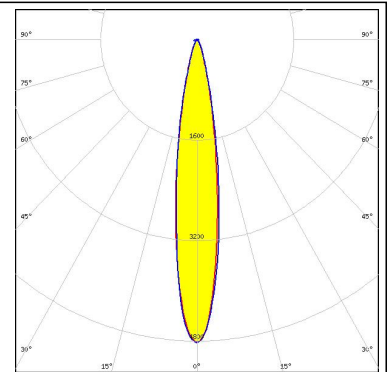
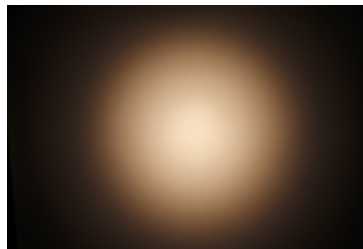

TRIDONIC

LED SLE G5 LES6
FWHM 15.0°
Efficiency 74 %
Peak intensity 5.800 cd/lm
Required components:
BJB: 47.319.6060

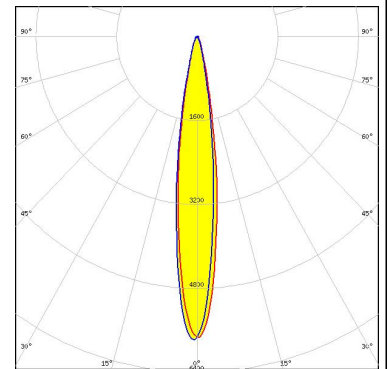
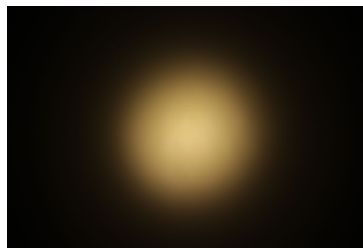

PHOTOMETRIC DATA (SIMULATED):

<p>bridgelux.</p> <p>LED V13 Gen7</p> <p>FWHM 26.0°</p> <p>Efficiency 94 %</p> <p>Peak intensity 3.660 cd/lm</p> <p>Required components: TE: 2213254-1</p>	
<p>bridgelux.</p> <p>LED V13 Gen7</p> <p>FWHM 26.0°</p> <p>Efficiency 93 %</p> <p>Peak intensity 3.200 cd/lm</p> <p>Required components: BJB: 47.319.2021</p>	
<p>bridgelux.</p> <p>LED V13 Gen7</p> <p>FWHM 24.0°</p> <p>Efficiency 91 %</p> <p>Peak intensity 3.240 cd/lm</p> <p>Required components: TE: 2213254-2</p>	
<p>bridgelux.</p> <p>LED V13 Gen7</p> <p>FWHM 26.0°</p> <p>Efficiency 95 %</p> <p>Peak intensity 3.750 cd/lm</p> <p>Required components: Bender Wirth: 477 Typ L1</p>	

PHOTOMETRIC DATA (SIMULATED):



LED V22 Gen7
FWHM 32.0°
Efficiency 85 %
Peak intensity 1.726 cd/lm
Required components:
BJB: 47.319.2030

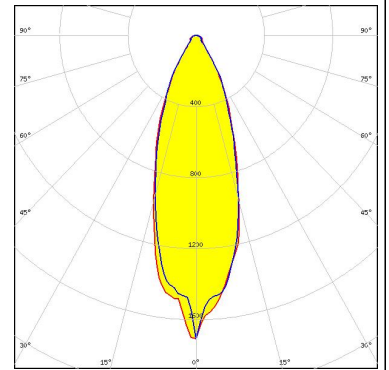

CITIZEN

LED CLL03x/CLU03x
FWHM 23.0°
Efficiency 81 %
Peak intensity 3.840 cd/lm
Required components:
BJB: 47.319.2021

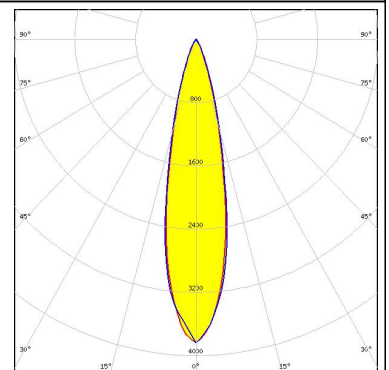

LED LUXEON CoB 1204/1205
FWHM 23.0°
Efficiency 72 %
Peak intensity 3.530 cd/lm
Required components:
TE: 2213130-2

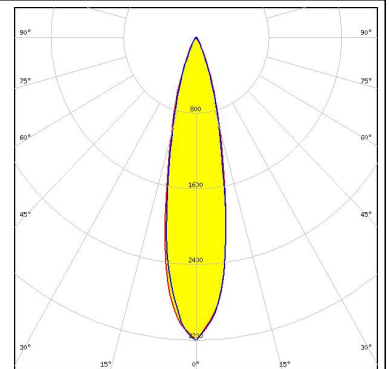

SHARP

LED Mega Zenigata (GW6DME)
FWHM 29.0°
Efficiency 77 %
Peak intensity 2.400 cd/lm
Required components:
Bender Wirth: 432 Typ Z1

GENERAL INFORMATION:

NOTE: The typical beam angle will be changed by different color, chip size and chip position tolerance. The typical total beam angle is the full angle measured where the luminous intensity is half of the peak value.

Due to use of high power COB's with this product, special attention to proper thermal design is highly recommended. LEDiL has no liability for direct, indirect or consecutive damages arising from the LEDiL products being used outside of the recommended temperature range.

MATERIALS:

As part of our continuous research and improvement processes, and to ensure the best possible quality and availability of our products, LEDiL reserves the right to change material grades without notice.

PRODUCT DATA USER AGREEMENT AND DISCLAIMER:

The measured data in the provided downloadable LEDiL Product Datasheets and Mechanical 2D-Drawings is rounded and provided as reference for planning. LEDiL Oy's optical specifications have been verified by conducting performance testing of the products in accordance with the company's quality system. The reported data are averaged results of multiple measurements with typical variation. LEDiL Oy reserves the right to without prior notification make changes and improvements to its products.

LEDiL Oy assumes neither warranty, nor guarantee nor any other liability of any kind for the contents and correctness of the provided data. The provided data has been generated with highest diligence but the provided data may in reality not represent the complete possible variation range of all intrinsic parameters. Therefore, in certain cases a deviation from the provided data could occur.

LEDiL Oy reserves the right to undertake technical changes of its products without further notification which could lead to changes in the provided data. LEDiL Oy assumes no liability of any kind for the possible deviation from any provided data or any other damage resulting from the usage of the provided data.

The user agrees to this disclaimer and user agreement with the download or usage of the provided files.

LEDiL Oy

Joensuunkatu 13
FI-24240 SALO
Finland

LEDiL Inc.

228 West Page Street
Suite D
Sycamore IL 60178
USA

Local sales and technical support

[www.ledil.com/
where_to_buy](http://www.ledil.com/where_to_buy)

Shipping locations

Salo, Finland
Hong Kong, China

Distribution Partners

[www.ledil.com/
where_to_buy](http://www.ledil.com/where_to_buy)