



IR Emitter and Detector Product Data Sheet

LTE-306

Spec No.: DS-50-92-0115

Effective Date: 06/19/2007

Revision: D

LITE-ON DCC

RELEASE

BNS-OD-FC001/A4

FEATURES

- * SELECTED TO SPECIFIC ON-LINE INTENSITY AND RADIANT INTENSITY RANGES
- * LOW COST MINIATURE PLASTIC SIDE LOOKING PACKAGE
- * MECHANICALLY AND SPECTRALLY MATCHED TO THE LTR-306 SERIES OF PHOTOTRANSISTOR

PACKAGE DIMENSIONS

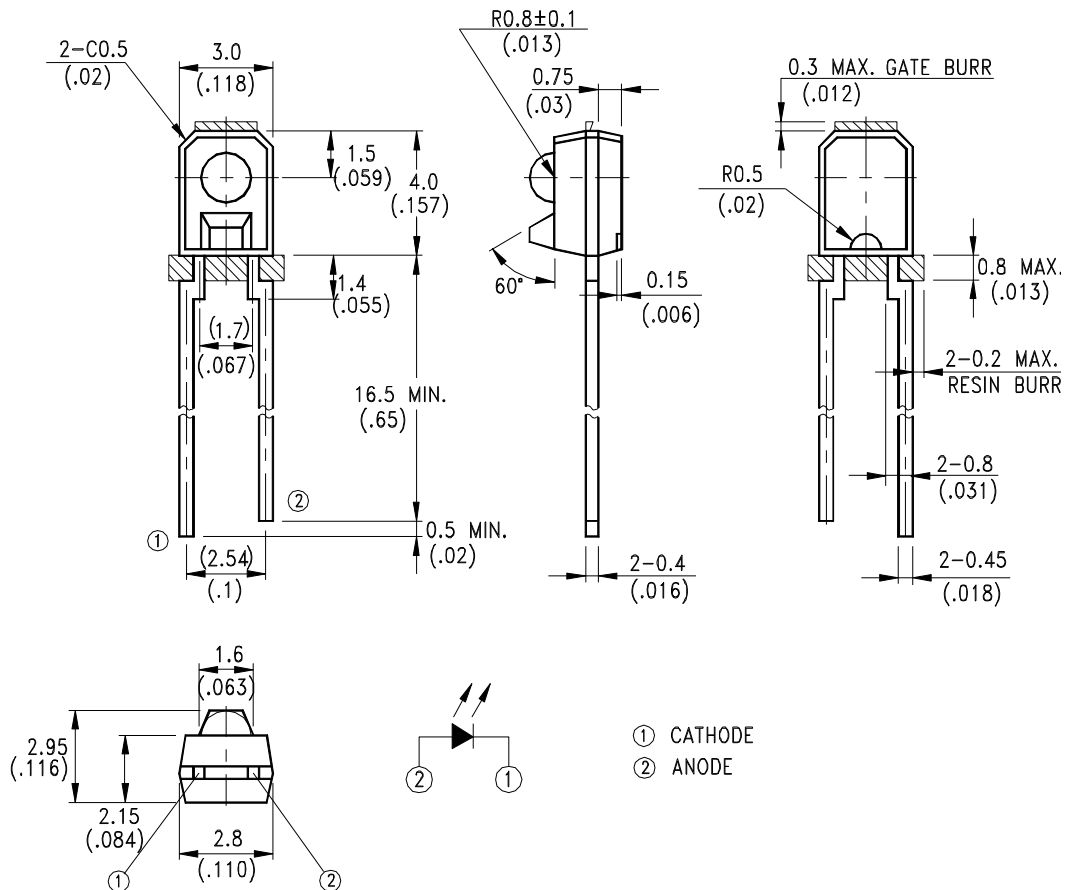

NOTES:

1. All dimensions are in millimeters (inches).
2. Tolerance is $\pm 0.25\text{mm}(.010\text{'})$ unless otherwise noted.
3. Lead spacing is measured where the leads emerge from the package.
4. Specifications are subject to change without notice.



LITE-ON TECHNOLOGY CORPORATION.

Property of Lite-On Only

ABSOLUTE MAXIMUM RATINGS AT TA=25°C

PARAMETER	MAXIMUM RATING	UNIT
Power Dissipation	75	mW
Peak Forward Current (300pps, 10 μ s pulse)	1	A
Continuous Forward Current	50	mA
Reverse Voltage	5	V
Operating Temperature Range	-40°C to + 85°C	
Storage Temperature Range	-55°C to + 100°C	
Lead Soldering Temperature [1.6mm(.063") From Body]	260°C for 5 Seconds	

ELECTRICAL OPTICAL CHARACTERISTICS AT TA=25°C

PARAMETER	SYMBOL	MIN.	TYP.	MAX.	UNIT	TEST CONDITION	BIN NO.
Aperture Radiant Incidence	E _e	0.088		0.168	mW/cm ²	I _F = 20mA	BIN A
		0.112		0.204			BIN B
		0.136		0.240			BIN C
		0.160		0.300			BIN D
		0.200		0.360			BIN E
		0.240		0.420			BIN F
		0.280		0.480			BIN G
		0.320					BIN H
Radiant Intensity	I _E	0.662		1.263	mW/sr	I _F = 20mA	BIN A
		0.842		1.534			BIN B
		1.023		1.805			BIN C
		1.203		2.256			BIN D
		1.504		2.707			BIN E
		1.805		3.158			BIN F
		2.105		3.609			BIN G
		2.403					BIN H
Peak Emission Wavelength	λ _{Peak}		940		nm	I _F = 20mA	
Spectral Line Half-Width	Δ λ		50		nm	I _F = 20mA	
Forward Voltage	V _F		1.2	1.6	V	I _F = 20mA	
Reverse Current	I _R			100	μ A	V _R = 5V	
Viewing Angle (See FIG.6)	2θ _{1/2}		30		deg.		

TYPICAL ELECTRICAL / OPTICAL CHARACTERISTICS CURVES

(25°C Ambient Temperature Unless Otherwise Noted)

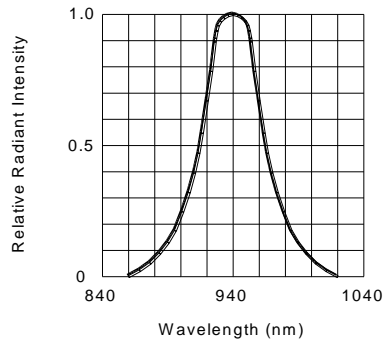

FIG.1 SPECTRAL DISTRIBUTION

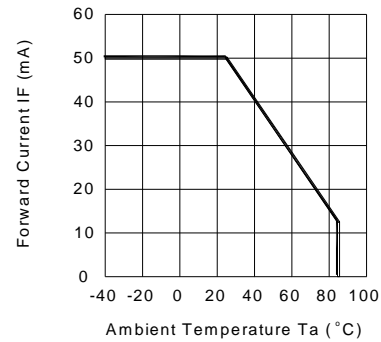

FIG.2 FORWARD CURRENT VS. AMBIENT TEMPERATURE

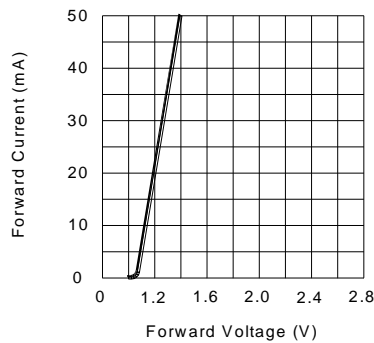

FIG.3 FORWARD CURRENT VS. FORWARD VOLTAGE

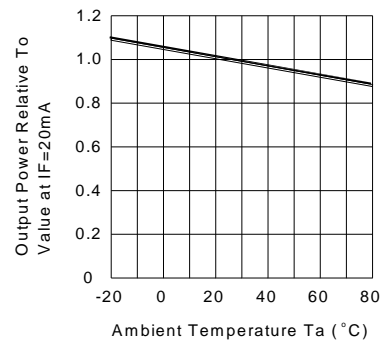

FIG.4 RELATIVE RADIANT INTENSITY VS. AMBIENT TEMPERATURE

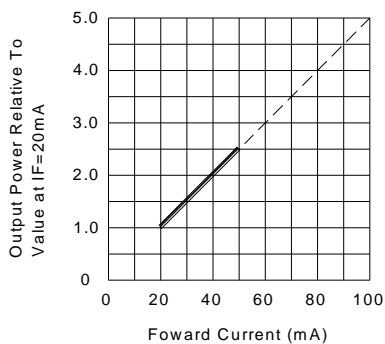

FIG.5 RELATIVE RADIANT INTENSITY VS. FORWARD CURRENT

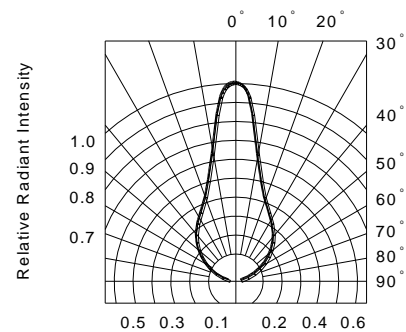

FIG.6 RADIATION DIAGRAM