

FLARE-MINI-A-PIN

~100° x 20° oval beam. Assembly with location pins.

TECHNICAL SPECIFICATIONS:

Dimensions	Ø 16.0 mm
Height	8.6 mm
Fastening	glue, pin
Colour	clear
Box size	
Box weight	3.7 kg
Quantity in Box	2400 pcs
ROHS compliant	yes ⓘ



MATERIAL SPECIFICATIONS:

Component	Type	Material	Colour
FLARE-MINI-A-PIN	Lens	PMMA	clear

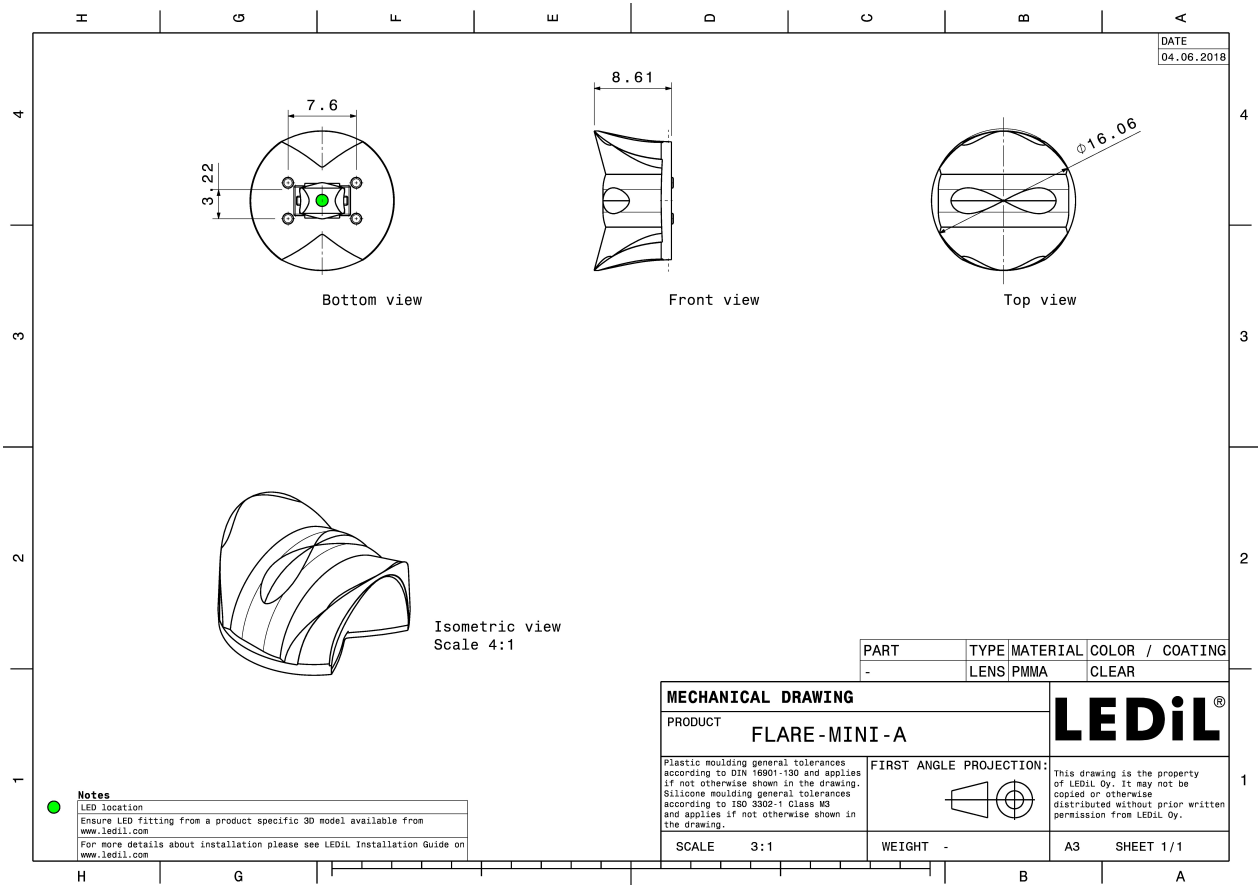

PHOTOMETRIC DATA (MEASURED):



LED XB-D
 FWHM 95.0 + 16.0°
 Efficiency 95 %
 Peak intensity 1.300 cd/lm
 Required components:

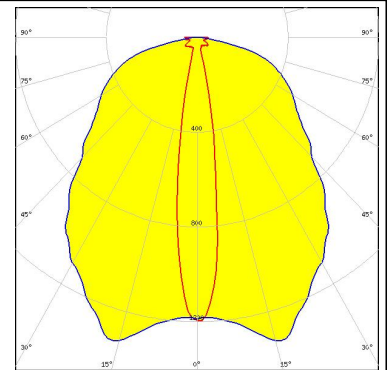

LED XP-E
 FWHM 95.0 + 17.0°
 Efficiency 95 %
 Peak intensity 1.500 cd/lm
 Required components:

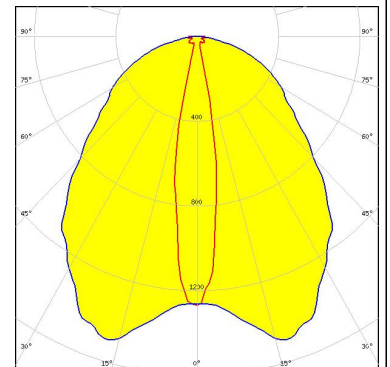
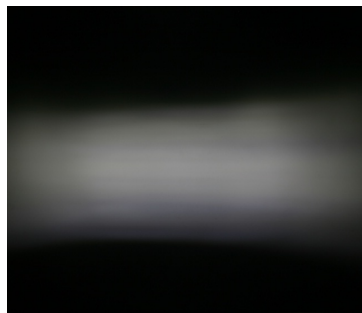

LED XP-E2
 FWHM 94.0 + 16.0°
 Efficiency 94 %
 Peak intensity 1.600 cd/lm
 Required components:

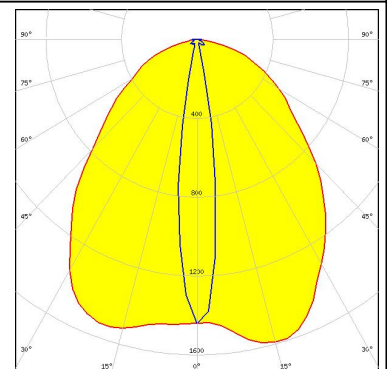

LED XP-G
 FWHM 99.0 + 21.0°
 Efficiency 95 %
 Peak intensity 1.070 cd/lm
 Required components:

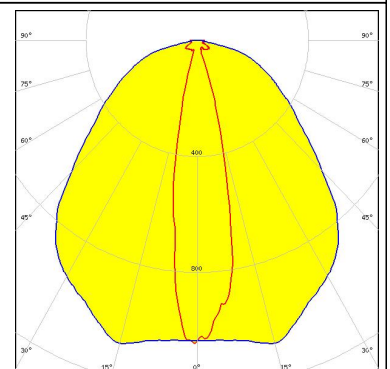

PHOTOMETRIC DATA (MEASURED):



LED XP-L
 FWHM 106.0 + 29.0°
 Efficiency 94 %
 Peak intensity 0.830 cd/lm
 Required components:

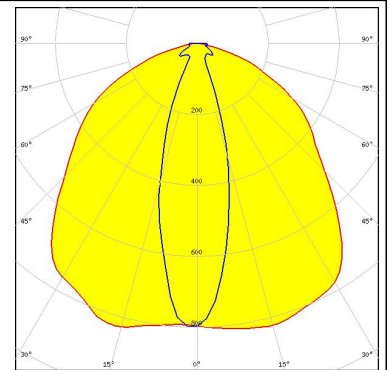
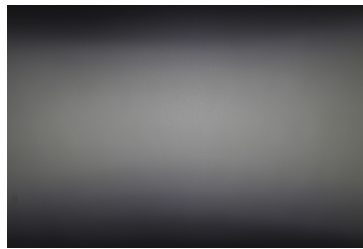

LED XP-L2
 FWHM 100.0 + 30.0°
 Efficiency 94 %
 Peak intensity 0.800 cd/lm
 Required components:

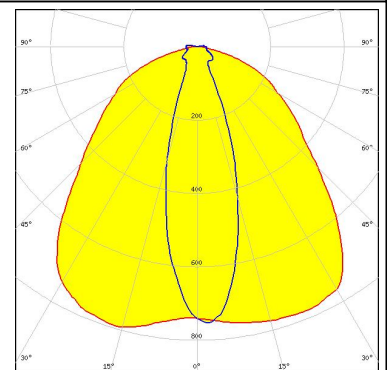
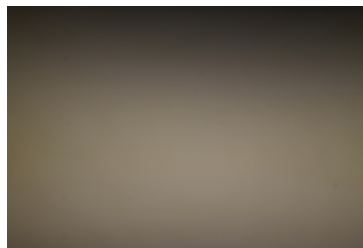

LED XT-E
 FWHM 95.0 + 19.0°
 Efficiency 94 %
 Peak intensity 1.200 cd/lm
 Required components:

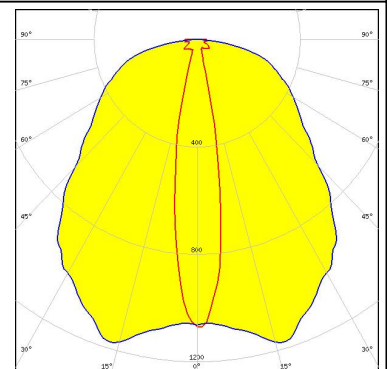

LED NCSxx19A
 FWHM 87.0 + 15.0°
 Efficiency 95 %
 Peak intensity 1.500 cd/lm
 Required components:

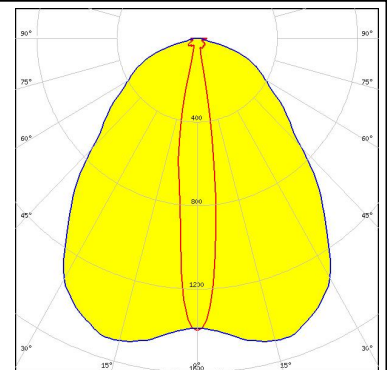

PHOTOMETRIC DATA (MEASURED):



LED NCSxx19B
 FWHM 95.0 + 17.0°
 Efficiency 94 %
 Peak intensity 1.500 cd/lm
 Required components:

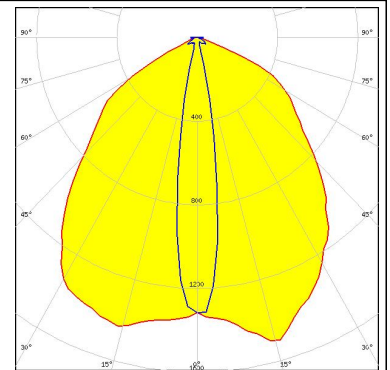

LED Oslon Square EC
 FWHM 90.0 + 20.0°
 Efficiency 94 %
 Peak intensity 1.250 cd/lm
 Required components:

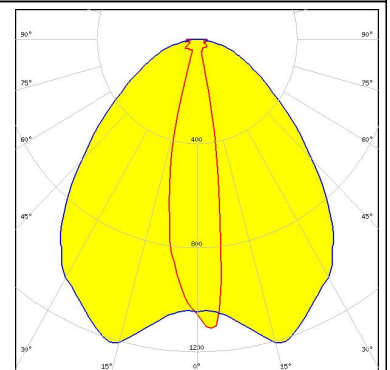

LED Oslon SSL 150
 FWHM 108.0 + 12.0°
 Efficiency 93 %
 Peak intensity 1.600 cd/lm
 Required components:

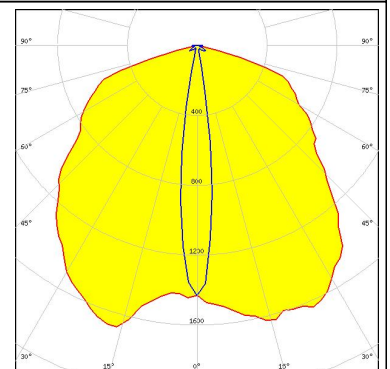
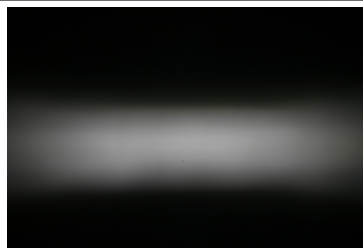

LED Oslon SSL 80
 FWHM 81.0 + 13.0°
 Efficiency 93 %
 Peak intensity 2.000 cd/lm
 Required components:

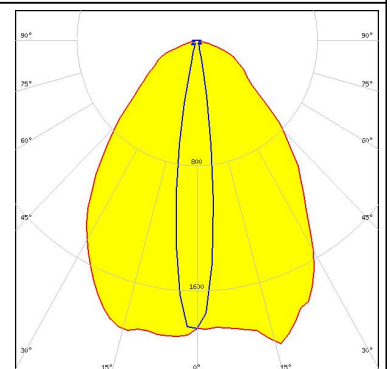
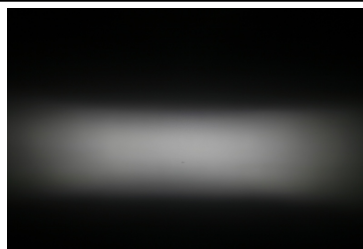

PHOTOMETRIC DATA (SIMULATED):



LED LUXEON C
FWHM 14.0 + 88.0°
Efficiency 93 %
Peak intensity 1.460 cd/lm
Required components:

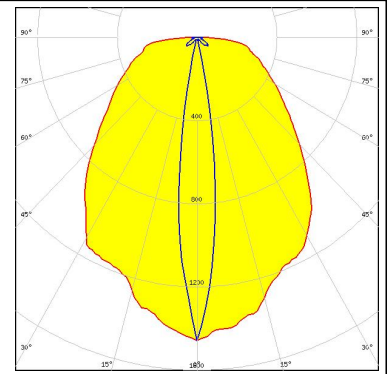

GENERAL INFORMATION:

NOTE: The typical beam angle will be changed by different color, chip size and chip position tolerance. The typical total beam angle is the full angle measured where the luminous intensity is half of the peak value.

MATERIALS:

As part of our continuous research and improvement processes, and to ensure the best possible quality and availability of our products, LEDiL reserves the right to change material grades without notice.

PRODUCT DATA USER AGREEMENT AND DISCLAIMER:

The measured data in the provided downloadable LEDiL Product Datasheets and Mechanical 2D-Drawings is rounded and provided as reference for planning. LEDiL Oy's optical specifications have been verified by conducting performance testing of the products in accordance with the company's quality system. The reported data are averaged results of multiple measurements with typical variation. LEDiL Oy reserves the right to without prior notification make changes and improvements to its products.

LEDiL Oy assumes neither warranty, nor guarantee nor any other liability of any kind for the contents and correctness of the provided data. The provided data has been generated with highest diligence but the provided data may in reality not represent the complete possible variation range of all intrinsic parameters. Therefore, in certain cases a deviation from the provided data could occur.

LEDiL Oy reserves the right to undertake technical changes of its products without further notification which could lead to changes in the provided data. LEDiL Oy assumes no liability of any kind for the possible deviation from any provided data or any other damage resulting from the usage of the provided data.

The user agrees to this disclaimer and user agreement with the download or usage of the provided files.

LEDiL Oy

Joensuunkatu 13
FI-24240 SALO
Finland

LEDiL Inc.

228 West Page Street
Suite D
Sycamore IL 60178
USA

Local sales and technical support

[www.ledil.com/
where_to_buy](http://www.ledil.com/where_to_buy)

Shipping locations

Salo, Finland
Hong Kong, China

Distribution Partners

[www.ledil.com/
where_to_buy](http://www.ledil.com/where_to_buy)