

RAIL TO RAIL CMOS DUAL OPERATIONAL AMPLIFIER (WITH **STANDBY** POSITION)

- RAIL TO RAIL INPUT AND OUTPUT VOLTAGE RANGES
- **STANDBY POSITION** : REDUCED CONSUMPTION (0.5µA) AND HIGH IMPEDANCE OUTPUTS
- SINGLE (OR DUAL) SUPPLY OPERATION FROM **2.7V TO 16V**
- EXTREMELY LOW INPUT BIAS CURRENT : **1pA typ**
- LOW INPUT OFFSET VOLTAGE : **5mV max.**
- SPECIFIED FOR **600Ω** AND **100Ω** LOADS
- LOW SUPPLY CURRENT : 200µA/Ampli ($V_{CC} = 3V$)

- **SPICE MACROMODEL** INCLUDED IN THIS SPECIFICATION

DESCRIPTION

The TS902 is a RAIL TO RAIL CMOS dual operational amplifier designed to operate with a single or dual supply voltage.

The input voltage range V_{icm} includes the two supply rails V_{CC}^+ and V_{CC}^- .

The output reaches :

- $V_{CC}^- + 50mV$ $V_{CC}^+ - 50mV$ with $R_L = 10k\Omega$
- $V_{CC}^- + 350mV$ $V_{CC}^+ - 400mV$ with $R_L = 600\Omega$

This product offers a broad supply voltage operating range from 2.7V to 16V and a supply current of only 200µA/amp. ($V_{CC} = 3V$).

Source and sink output current capability is typically 40mA (at $V_{CC} = 3V$), fixed by an internal limitation circuit.

The TS902 can be put on **STANDBY** position (only 0.5µA and high impedance outputs).

ORDER CODE

Part Number	Temperature Range	Package
		D
TS902I	-40, +125°C	•

N = Dual in Line Package (DIP)
 D = Small Outline Package (SO) - also available in Tape & Reel (DT)



PIN CONNECTIONS (top view)

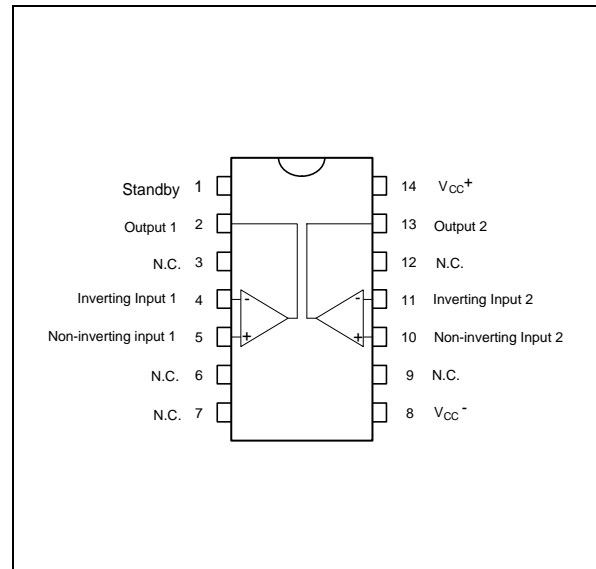

SCHEMATIC DIAGRAM (1/2 TS902)

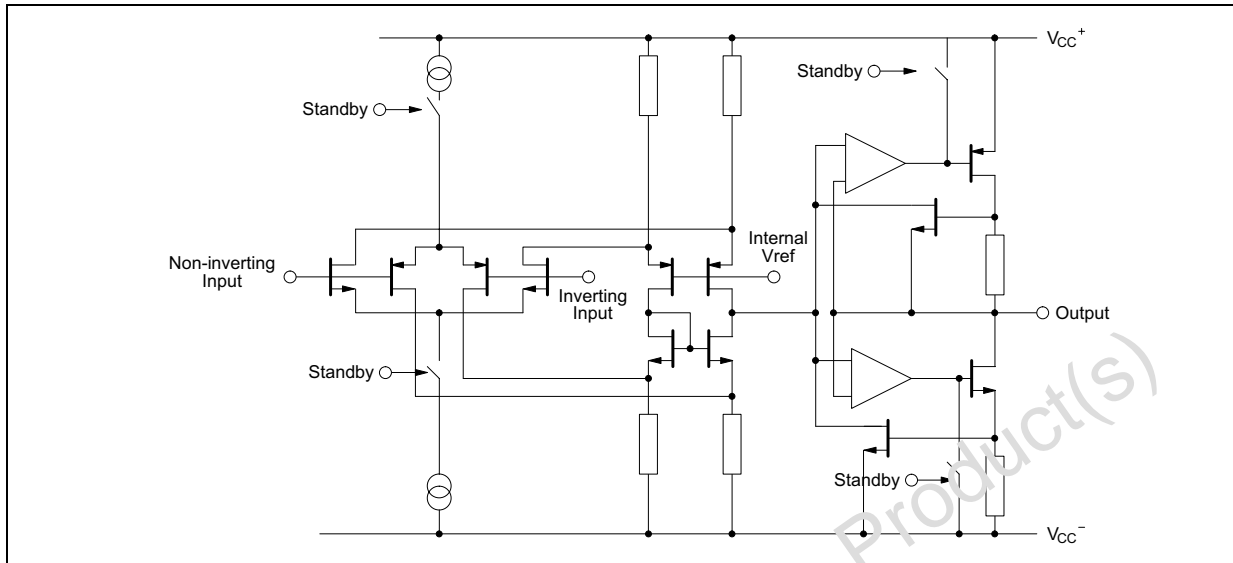

STANDBY POSITION

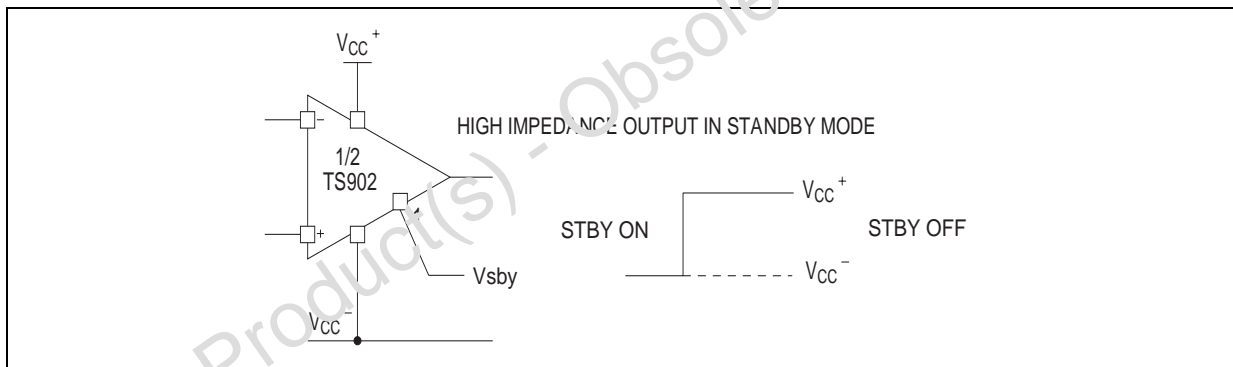

ABSOLUTE MAXIMUM RATINGS

Symbol	Parameter	Value	Unit
V_{CC}	Supply voltage ¹⁾	18	V
V_{id}	Differential Input Voltage ²⁾	± 18	V
V_i	Input Voltage ³⁾	-0.3 to 18	V
I_{in}	Current on Inputs	± 50	mA
I_o	Current on Outputs	± 130	mA
T_{oper}	Operating Free Air Temperature Range TS902I	-40 to + 125	$^{\circ}C$
T_{stg}	Storage Temperature	-65 to +150	$^{\circ}C$

1. All voltages values, except differential voltage are with respect to network ground terminal.
2. Differential voltages are non-inverting input terminal with respect to the inverting input terminal.
3. The magnitude of input and output voltages must never exceed $V_{CC}^{+} + 0.3V$.

OPERATING CONDITIONS

Symbol	Parameter	Value	Unit
V_{CC}	Supply voltage	2.7 to 16	V
V_{icm}	Common Mode Input Voltage Range	$V_{CC}^{-} - 0.2$ to $V_{CC}^{+} + 0.2$	V

ELECTRICAL CHARACTERISTICS
 $V_{CC}^+ = 10V$, $V_{CC}^- = 0V$, R_L , C_L connected to $V_{CC/2}$, Standby OFF, $T_{amb} = 25^\circ C$ (unless otherwise specified)

Symbol	Parameter	Min.	Typ.	Max.	Unit
V_{io}	Input Offset Voltage ($V_{ic} = V_o = V_{CC/2}$) $T_{min.} \leq T_{amb} \leq T_{max.}$			10 12	mV
ΔV_{io}	Input Offset Voltage Drift		5		$\mu V/^\circ C$
I_{io}	Input Offset Current ¹⁾ $T_{min.} \leq T_{amb} \leq T_{max.}$		1	100 200	pA
I_{ib}	Input Bias Current ¹⁾ $T_{min.} \leq T_{amb} \leq T_{max.}$		1	150 300	pA
I_{CC}	Supply Current (per amplifier, $A_{VCL} = 1$, no load) $T_{min.} \leq T_{amb} \leq T_{max.}$		400	600 700	μA
CMR	Common Mode Rejection Ratio $V_{ic} = 3$ to $7V$, $V_o = 5V$ $V_{ic} = 0$ to $10V$, $V_o = 5V$		90 75		dB
SVR	Supply Voltage Rejection Ratio ($V_{CC}^+ = 5$ to $10V$, $V_o = V_{CC/2}$)		95		dB
A_{vd}	Large Signal Voltage Gain ($R_L = 10k\Omega$, $V_o = 2.5V$ to $7.5V$) $T_{min.} \leq T_{amb} \leq T_{max.}$	15 10	60		V/mV
V_{OH}	High Level Output Voltage ($V_{id} = 1V$) $T_{min.} \leq T_{amb} \leq T_{max.}$	$R_L = 10k\Omega$ 9.85 $R_L = 600\Omega$ 9 $R_L = 100\Omega$ 9.8 $R_L = 10\Omega$ 9 $R_L = 60\Omega$	9.95 9.35 7.8		V
V_{OL}	Low Level Output Voltage ($V_{id} = -1V$) $T_{min.} \leq T_{amb} \leq T_{max.}$	$R_L = 10k\Omega$ $R_L = 600\Omega$ $R_L = 100\Omega$ $R_L = 10k\Omega$ $R_L = 600\Omega$	50 650 2300	150 800 150 900	mV
I_o	Output Short Circuit Current ($V_{id} = \pm 1V$) Source ($V_o = V_{CC}$) Sink ($V_o = V_{CC}^+$)		60 60		mA
GBP	Gain Bandwidth Product ($A_{VCL} = 100$, $R_L = 10k\Omega$, $C_L = 100pF$, $f = 100kHz$)		1.4		MHz
SR	Slew Rate ($A_{VCL} = 1$, $R_L = 10k\Omega$, $C_L = 100pF$, $V_i = 2.5V$ to $7.5V$)		1		V/ μs
ϕ_m	Phase Margin		40		Degrees
e_n	Equivalent Input Noise Voltage ($R_s = 100\Omega$, $f = 1kHz$)		30		nV/ \sqrt{Hz}
THD	Total Harmonic Distortion ($A_{VCL} = 1$, $R_L = 10k\Omega$, $C_L = 100pF$, $V_o = 4.75V$ to $5.25V$, $f = 1kHz$)		0.02		%
C_{in}	Input Capacitance		1.5		pF
V_{O1}/V_{O2}	Channel Separation ($f = 1kHz$)		120		dB

1. Maximum values including unavoidable inaccuracies of the industrial test

STANDBY MODE
 $V_{CC}^+ = 10V$, $V_{CC}^- = 0V$, $T_{amb} = 25^\circ C$ (unless otherwise specified)

Symbol	Parameter	Min.	Typ.	Max.	Unit
$V_{inSBY/ON}$	Pin 1 Threshold Voltage for STANDBY ON		8.2		V
$V_{inSBY/OFF}$	Pin 1 Threshold Voltage for STANDBY OFF		8.5		V
$I_{CC SBY}$	Total Consumption in Standby Position (STANDBY ON)		1		μA

TYPICAL CHARACTERISTICS

Figure 1a : Supply Current (each amplifier) vs Supply Voltage

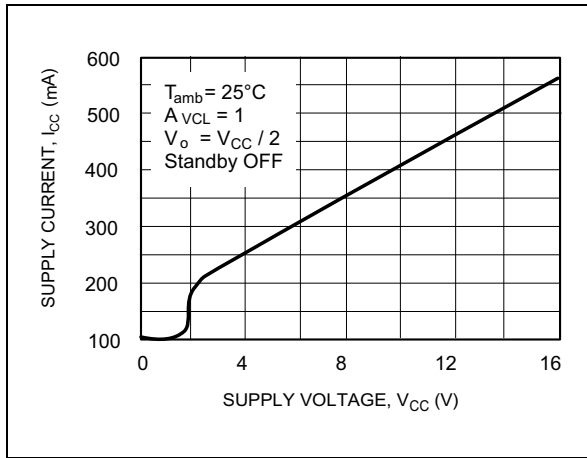

Figure 1b : Supply Current (each amplifier) vs Supply Voltage (in STANDBY mode)

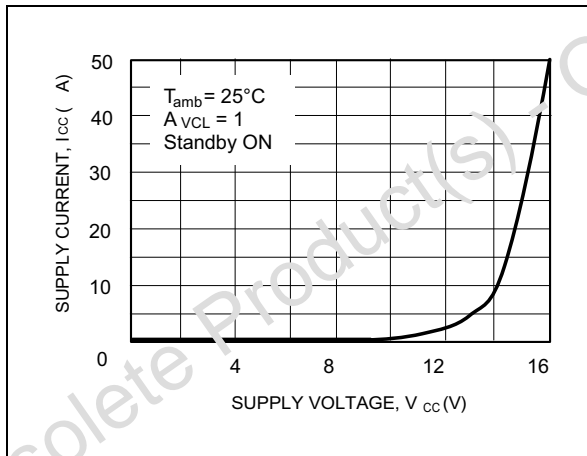

Figure 2 : Input Bias Current vs Temperature

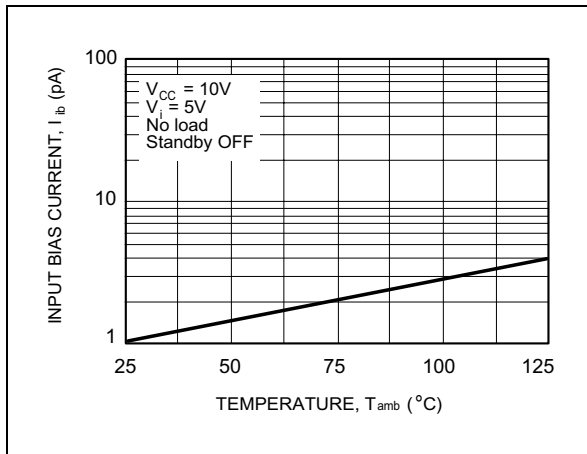

Figure 3a : High Level Output Voltage vs High Level Output Current

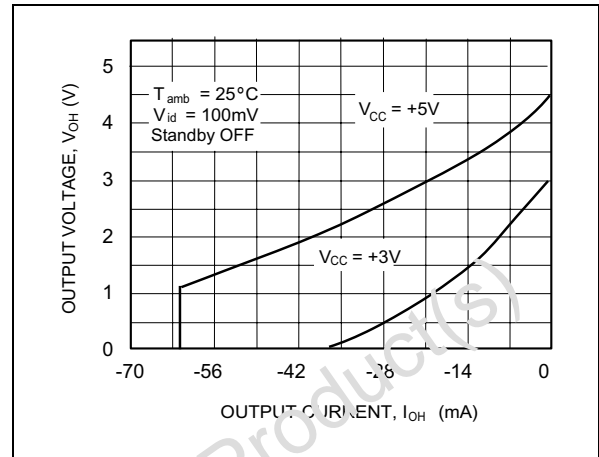

Figure 3b : High Level Output Voltage vs High Level Output Current

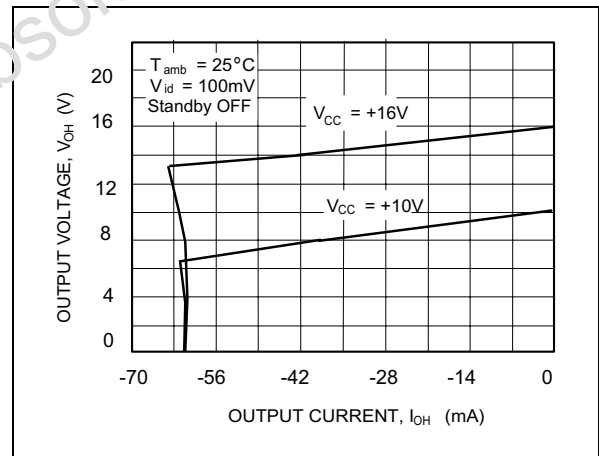

Figure 4a : Low Level Output Voltage vs Low Level Output Current

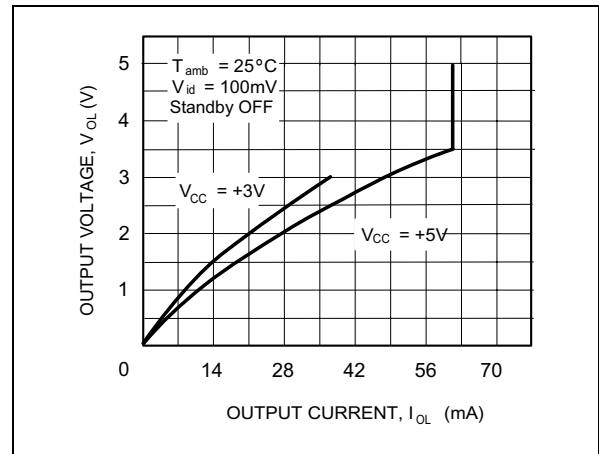

Figure 4b : Low Level Output Voltage vs Low Level Output Current

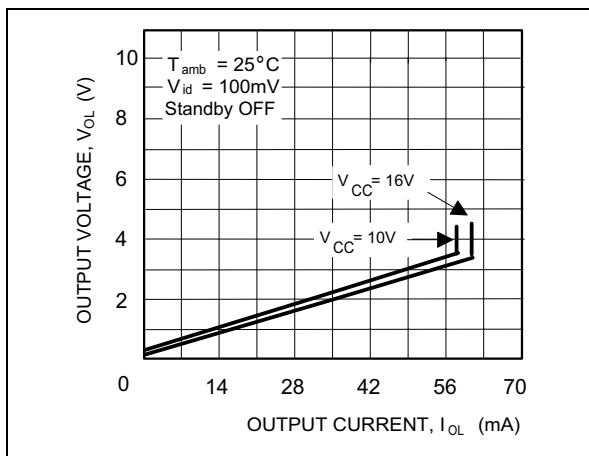

Figure 6a : Gain Bandwidth Product vs Supply Voltage

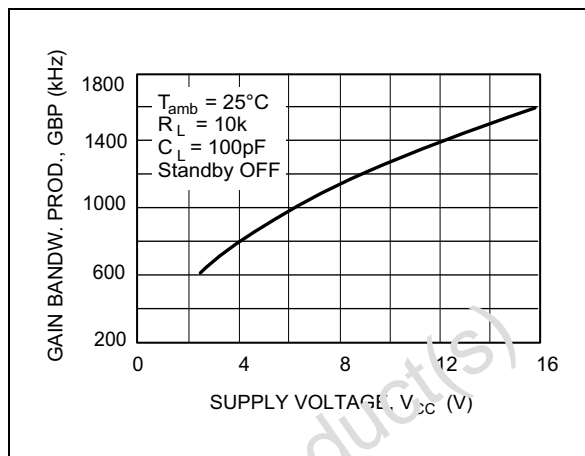

Figure 5a : Gain and Phase vs Frequency

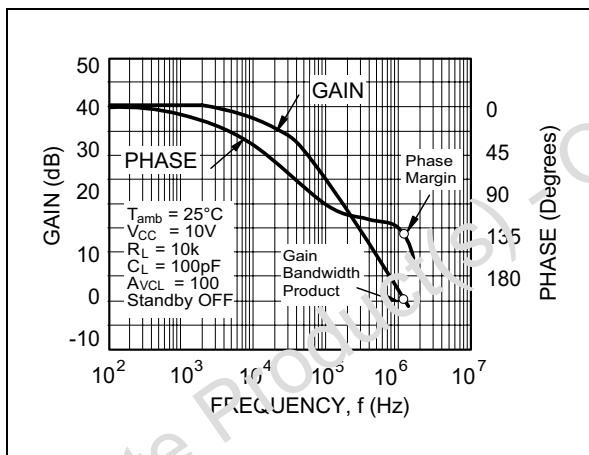

Figure 6b : Gain Bandwidth Product vs Supply Voltage

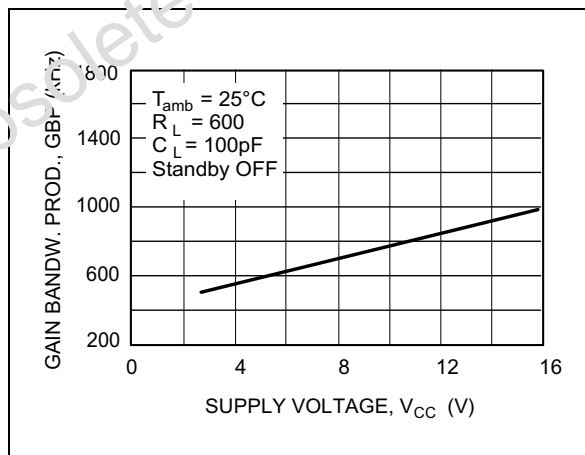

Figure 6c : Gain and Phase vs Frequency

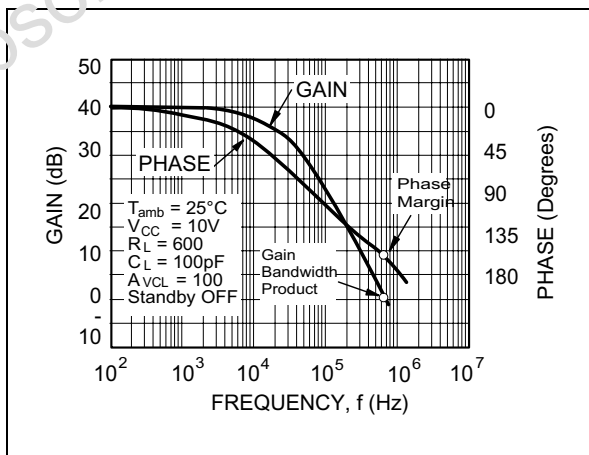

Figure 7a : Phase Margin vs Supply Voltage

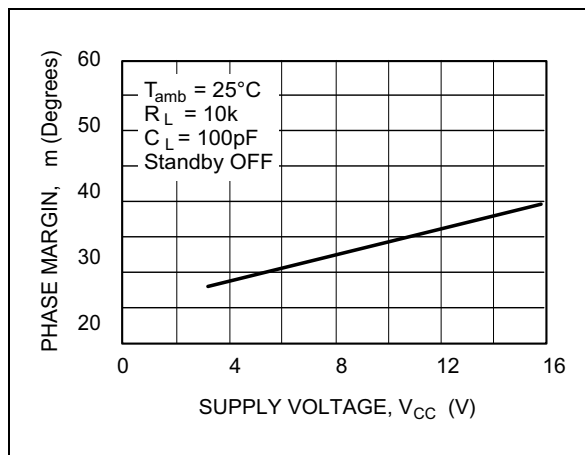

Figure 7b : Phase Margin vs Supply Voltage

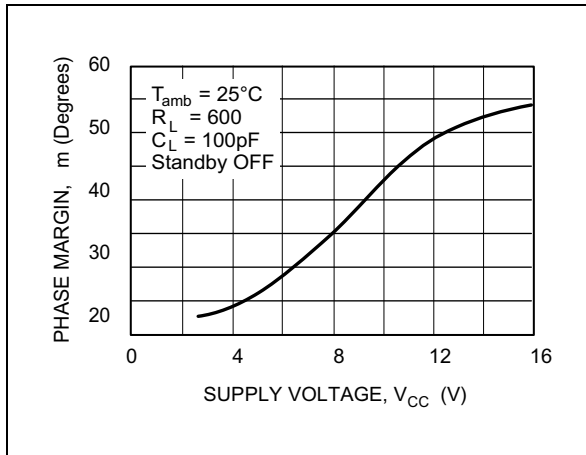
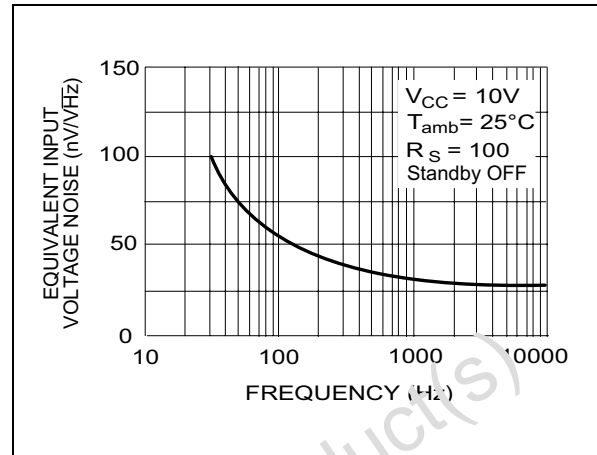

Figure 8 : Input Voltage Noise vs Frequency



STANDBY APPLICATION

The two operators of the TS902 are **both** put on **STANDBY**.

In this configuration (standby ON) :

- The **total consumption** of the circuit is considerably reduced down to 0.5 μ A ($V_{CC} = 3V$). This standby consumption vs V_{CC} curve is given figure 7a.
- The **both outputs** are in **high impedance** state. No output current can then be sourced or sinked by the device.

The standby pin 1 should never stay unconnected.

- The “**standby OFF**” state, is reached when the pin 1 voltage is **higher than $V_{in\ SBY/OFF}$** .
- The “**standby ON**” state is assured by a pin 1 voltage **lower than $V_{in\ SBY/ON}$** . (see electrical characteristics)

MACROMODELS

Applies to : TS902I

** Standard Linear Ics Macromodels, 1993.
 ** CONNECTIONS :
 * 1 INVERTING INPUT
 * 2 NON-INVERTING INPUT
 * 3 OUTPUT
 * 4 POSITIVE POWER SUPPLY
 * 5 NEGATIVE POWER SUPPLY
 * 6 STANDBY

```
.SUBCKT TS902 1 3 2 4 5 6 (analog)
*****
.MODEL MDTH D IS=1E-8 KF=6.563355E-14 CJO=10F
* INPUT STAGE
CIP 2 5 1.500000E-12
CIN 1 5 1.500000E-12
EIP 10 0 2 0 1
EIN 16 0 1 0 1
RIP 10 11 6.500000E+00
RIN 15 16 6.500000E+00
RIS 11 15 7.655100E+00
DIP 11 12 MDTH 400E-12
DIN 15 14 MDTH 400E-12
VOFP 12 13 DC 0.000000E+00
VOFN 13 14 DC 0
FPOL 13 0 VSTB 1
CPS 11 15 3.82E-08
DINN 17 13 MDTH 400E-12
VIN 17 5 -0.5000000E+00
DINR 15 18 MDTH 400E-12
VIP 4 18 -0.5000000E+00
FCP 4 5 VOFP 8.6E+00
FCN 5 4 VOFN 8.6E+00
ISTB0 5 4 900NA
* AMPLIFYING STAGE
FIP 0 19 VOFP 5.500000E+02
FIN 0 19 VOFN 5.500000E+02
RG1 19 120 5.087344E+05
GCOM1 120 5 POLY(1) 110 109 LEVEL=1 6.25E+11
RG2 121 19 5.087344E+05
GCOM2 121 4 POLY(1) 110 109 LEVEL=1 6.25E+11
CC 19 29 2.200000E-08
HZTP 30 29 VOFP 12.33E+02
HZTN 5 30 VOFN 12.33E+02
```

```
DOPM 19 22 MDTH 400E-12
DONM 21 19 MDTH 400E-12
HOPM 22 28 VOUT 3135
VIPM 28 4 150
HONM 21 27 VOUT 3135
VINM 5 27 150
EOUT 26 23 19 5 1
VOUT 23 5 0
ROUT 26 103 65
COUT 103 5 1.000000E-12
GCOM 103 3 POLY(1) 110 109 LEVEL=1 6.25E+11
* OUTPUT SWING
DOP 19 68 MDTH 400E-12
VOP 4 25 1.924
HSCP 68 25 VSCP1 1E8
DON 69 19 MDTH 400E-12
VON 24 5 2.4419107
HSCN 24 69 VSCN1 1.5E8
VSCTHP 60 61 0.1375
DSCP1 61 63 MDTH 400E-12
VSCP1 63 64 0
ISCP 64 0 1.000000E-8
DSCP2 0 64 MDTH 400E-12
DSCN2 0 74 MDTH 400E-12
ISCN 74 0 1.000000E-8
VSCN1 73 74 0
DSCN1 71 73 MDTH 400E-12
VSCTHN 71 70 -0.75
ESCP 60 0 2 1 500
ESCN 70 0 2 1 -2000
* STAND BY
RMI1 4 111 1E+12
RMI2 5 111 1E+12
RSTBIN 6 0 1E+12
ESTBIN 106 0 6 0 1
ESTBREF 106 107 111 0 1
DSTB1 107 108 MDTH 400E-12
VSTB 108 109 0
ISTB 109 0 40U
RSTB 109 110 1
DSTB2 0 110 MDTH 400E-12
.ENDS
```

ELECTRICAL CHARACTERISTICS

$V_{CC+} = 5V, V_{CC-} = 0V, R_L, C_L$ connected to $V_{CC/2}$, Standby OFF, $T_{amb} = 25^{\circ}C$ (unless otherwise specified)

Symbol	Conditions	Value	Unit
V_{io}		0	mV
A_{vd}	$R_L = 10k\Omega$	30	V/mV
I_{CC}	No load, per operator	230	μA
V_{icm}		-0.2 to 5.2	V
V_{OH}	$R_L = 10k\Omega$	4.95	V
V_{OL}	$R_L = 10k\Omega$	50	mV
I_{sink}	$V_O = 10V$	60	mA
I_{source}	$V_O = 0V$	60	mA
GBP	$R_L = 10k\Omega, C_L = 100pF$	0.8	MHz
SR	$R_L = 10k\Omega, C_L = 100pF$	0.8	V/ μs
ϕ_m	$R_L = 10k\Omega, C_L = 100pF$	30	Degrees
$I_{CC\ STBY}$	$V_{STBY} = 0V$	500	nA



PACKAGE MECHANICAL DATA
 14 PINS - PLASTIC MICROPACKAGE (SO)

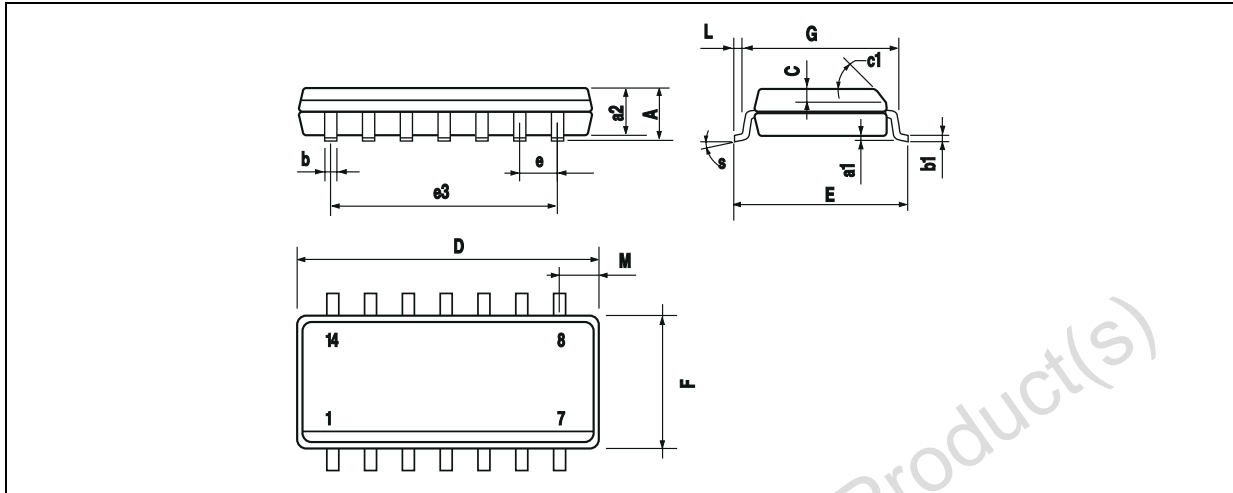

Dim.	Millimeters			Inches		
	Min.	Typ.	Max.	Min.	Typ.	Max.
A			1.75			0.069
a1	0.1		0.2	0.004		0.008
a2			1.6			0.063
b	0.35		0.46	0.014		0.018
b1	0.19		0.25	0.007		0.010
C		0.5			0.020	
c1	45° (typ.)					
D (1)	8.55		8.75	0.336		0.344
E	5.3		6.2	0.228		0.244
e		1.27			0.050	
e3		7.62			0.300	
F (1)	3.8		4.0	0.150		0.157
G	4.6		5.3	0.181		0.208
L	0.5		1.27	0.020		0.050
M			0.68			0.027
S	8° (max.)					

Note : (1) D and F do not include mold flash or protrusions - Mold flash or protrusions shall not exceed 0.15mm (.066 inc) ONLY FOR DATA BOOK.

Information furnished is believed to be accurate and reliable. However, STMicroelectronics assumes no responsibility for the consequences of use of such information nor for any infringement of patents or other rights of third parties which may result from its use. No license is granted by implication or otherwise under any patent or patent rights of STMicroelectronics. Specifications mentioned in this publication are subject to change without notice. This publication supersedes and replaces all information previously supplied. STMicroelectronics products are not authorized for use as critical components in life support devices or systems without express written approval of STMicroelectronics.

© The ST logo is a registered trademark of STMicroelectronics

© 2001 STMicroelectronics - Printed in Italy - All Rights Reserved
 STMicroelectronics GROUP OF COMPANIES

Australia - Brazil - Canada - China - Finland - France - Germany - Hong Kong - India - Israel - Italy - Japan - Malaysia
 Malta - Morocco - Singapore - Spain - Sweden - Switzerland - United Kingdom - United States

© <http://www.st.com>