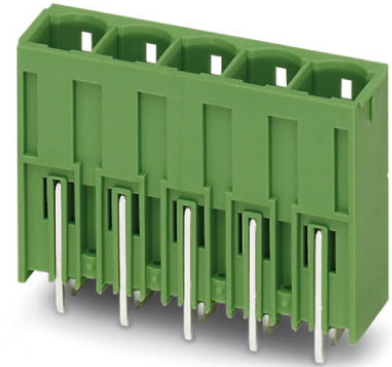

## PCV 6-16/ 8-G1-10,16

Order No.: 1998849

The figure shows a 5-pos. version of the product

<http://eshop.phoenixcontact.de/phoenix/treeViewClick.do?UID=1998849>

Header, Nominal current: 76 A, Nom. voltage: 1000 V, Pitch: 10.16 mm, Number of positions: 8, Color: green, Assembly: Soldering

### Commercial data

EAN	4046356038348
Pack	50 pcs.
Customs tariff	85366990
Weight/Piece	0.0341 KG
Catalog page information	Page 422 (CC-2009)

### Product notes

WEEE/RoHS-compliant since:  
05/18/2004

<http://www.download.phoenixcontact.com>  
Please note that the data given here has been taken from the online catalog. For comprehensive information and data, please refer to the user documentation. The General Terms and Conditions of Use apply to Internet downloads.

### Technical data

#### Dimensions / positions

Length	13.4 mm
Height	34 mm
Pitch	10.16 mm
Dimension a	71.12 mm
Number of positions	8

Pin dimensions	1 x 1.2 mm
Pin spacing	10.16 mm
Hole diameter	1.7 mm

**Technical data**

Insulating material group	I
Rated surge voltage (III/3)	6 kV
Rated surge voltage (III/2)	8 kV
Rated surge voltage (II/2)	8 kV
Rated voltage (III/2)	1000 V
Rated voltage (II/2)	1000 V
Connection in acc. with standard	EN-VDE
Nominal current $I_N$	76 A (41 A in combination with PC 6 plug)
Nominal voltage $U_N$	1000 V
Maximum load current	76 A (41 A in combination with PC 6 plug)
Insulating material	PA
Inflammability class acc. to UL 94	V0

**Certificates / Approvals**



Certification CB, CCA, CUL, SEV, UL

**CUL**

Nominal voltage $U_N$	600 V
Nominal current $I_N$	5 A

**UL**

Nominal voltage $U_N$	600 V
Nominal current $I_N$	5 A

**Accessories**

Item	Designation	Description
<b>General</b>		
1970016	CS-IPC 16/ 6	Coding pin, serves to ensure correct polarization on the PCB during manual mounting
<b>Plug/Adapter</b>		
1600027	CP-HCC 4	Coding profile, Color: red

**Diagrams/Drawings**

Drilling plan/solder pad geometry

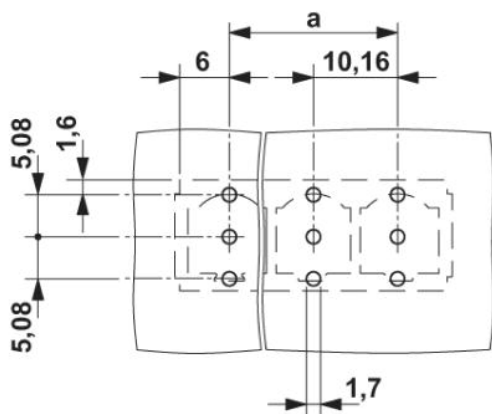

Diagram

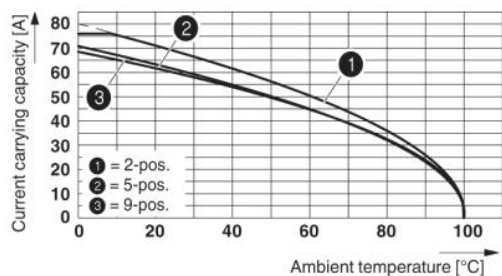

Dimensioned drawing

---

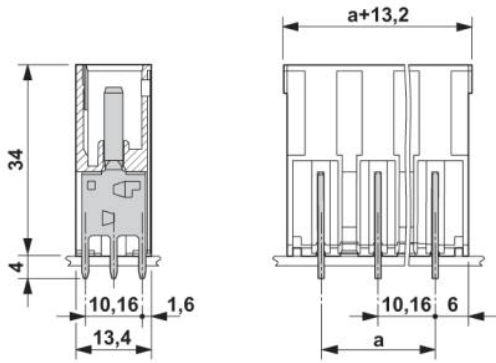

**Address**

PHOENIX CONTACT Inc., USA  
586 Fulling Mill Road  
Middletown, PA 17057, USA  
Phone (800) 888-7388  
Fax (717) 944-1625  
<http://www.phoenixcon.com>



© 2010 Phoenix Contact  
Technical modifications reserved;