

LOC		DIST		REVISIONS			
P	LTR	DESCRIPTION	DATE	DN	APVD		
C		REVISED PER ECO-06-007841	18JUL06	JDP	MB		

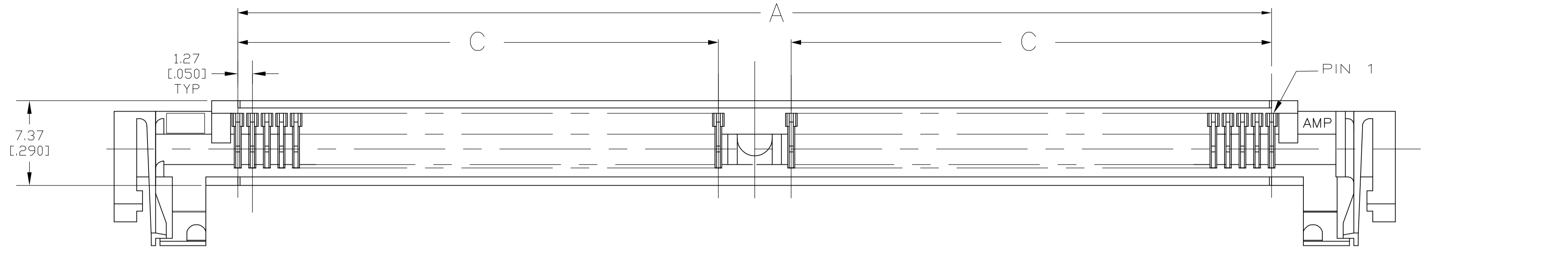

- △ HOUSING-MATERIAL : LIQUID-CRYSTAL-POLYMER.
- △ CONTACT-MATERIAL : PHOS. BRONZE, AMP 100-255.
- △ CONTACT-PLATE 0.00127 [.000050] MIN NICKEL ALL OVER.
- △ CONTACT-PLATE 0.00076 [.000030] MIN. GOLD AT CONTACT PTS.
- △ CONTACT SOLDER TAILS-PLATE 0.00508 [.000200] MIN MATTE TIN.
- 6. IN ADDITION TO THOSE RECOMMENDED "SIMM" P.C. BOARD DIMENSIONS AND TOLERANCES SHOWN, ALL JEDEC SPECIFICATIONS APPLY AS SHOWN ON MO-116, ISSUE A.
- 7. RECOMMENDED MATING S.I.M.M. TAB METALLURGY:
 BASE METAL-COPPER. PLATING TO BE 0.00076 [.000030] MIN GOLD OVER 0.00127 [.000050] MIN NICKEL.
- △ DATE CODE INFORMATION (YEAR WEEK), LOCATED APPROXIMATELY AS SHOWN ON OPPOSITE SIDE ONLY.

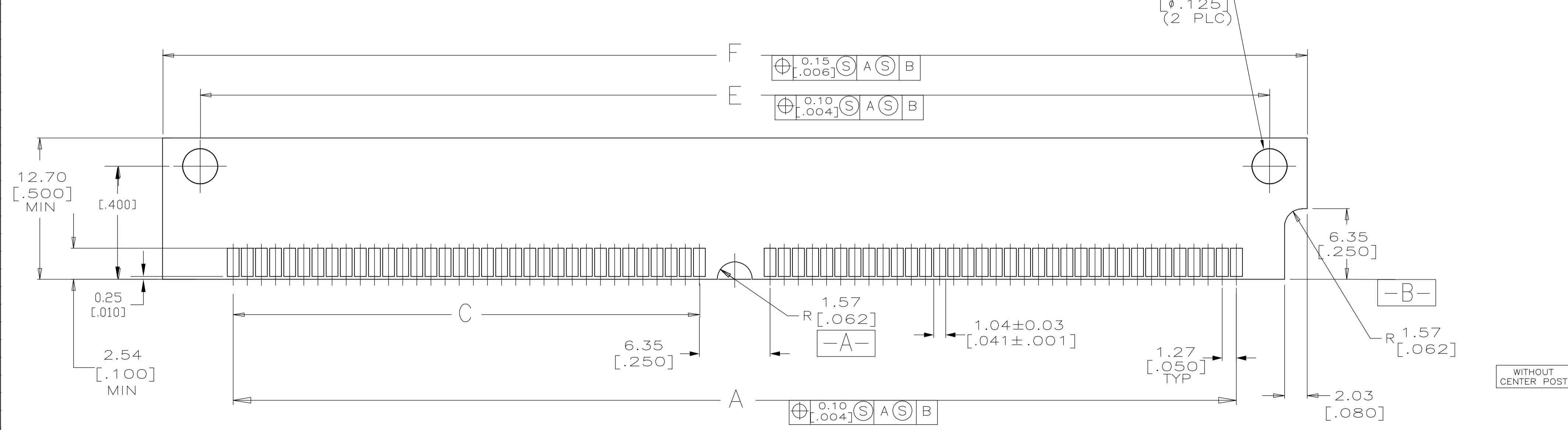
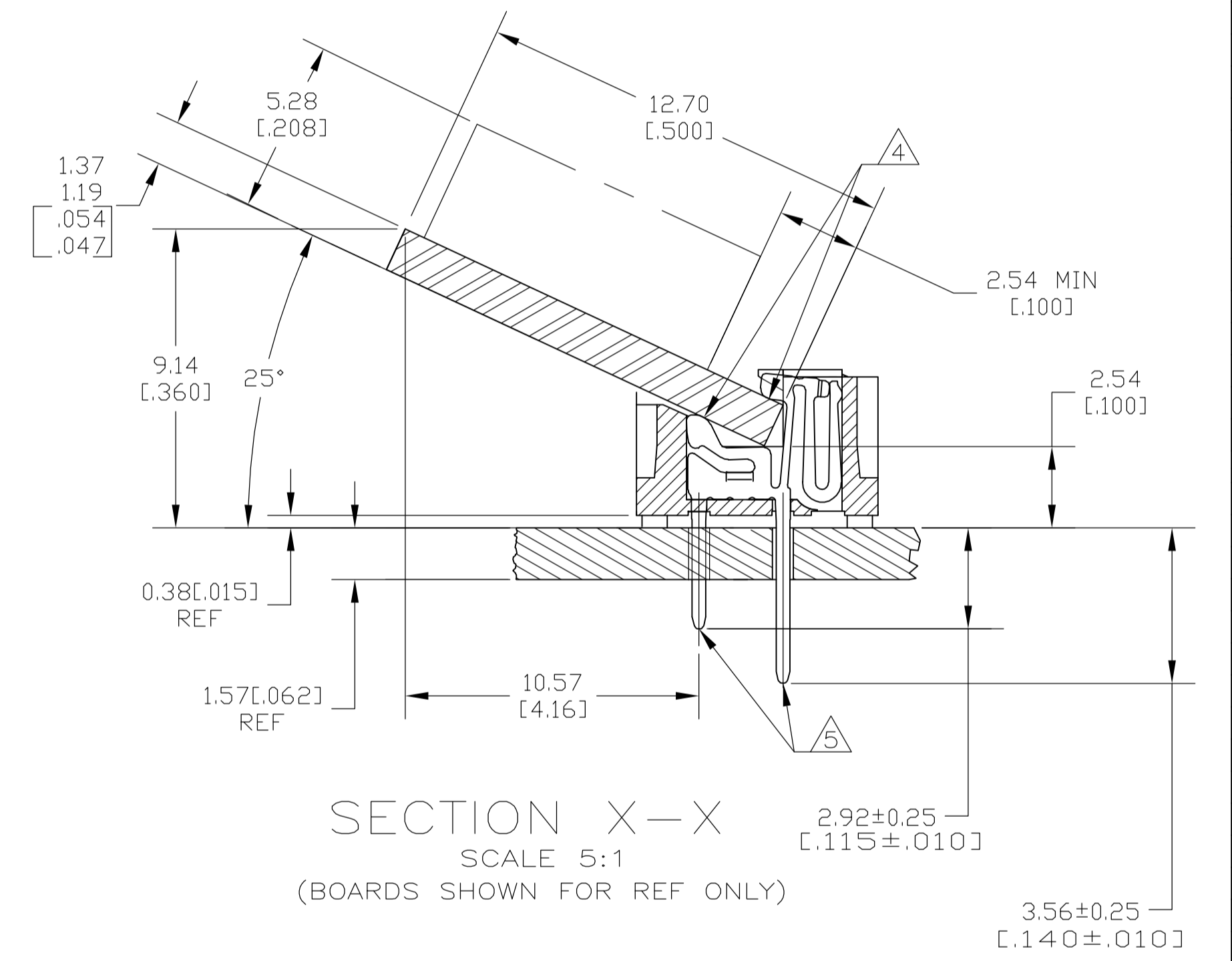
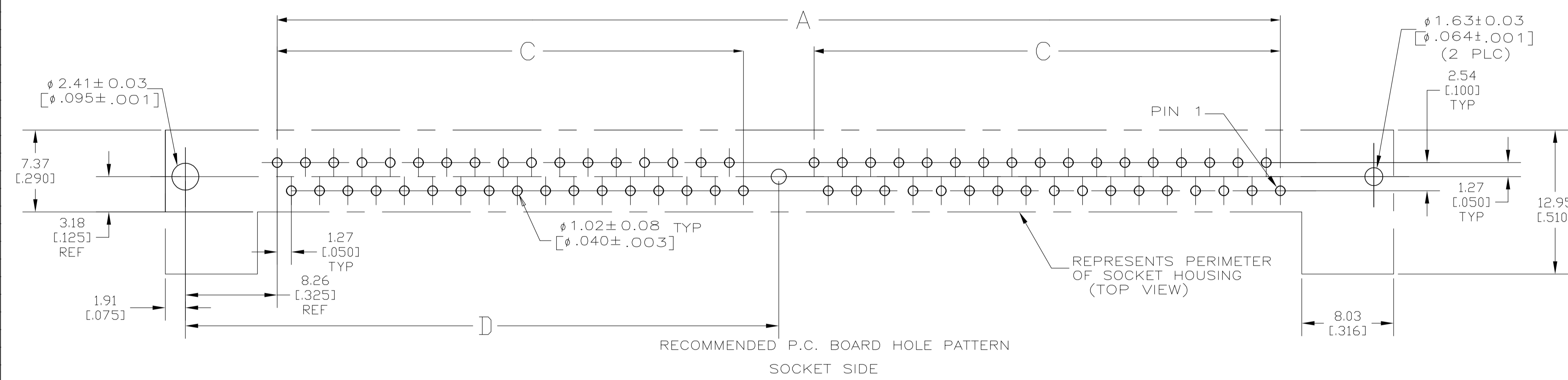
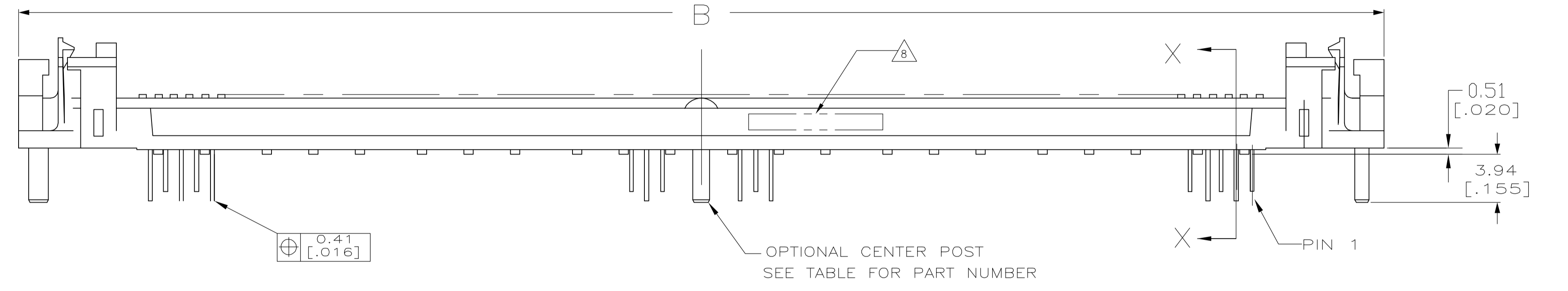

WITHOUT CENTER POST	F	E	D	C	B	A	NO OF POSN	PART NO
107.95 [4.250]	101.19 [3.984]	55.88 [2.200]	44.45 [1.750]	115.57 [4.550]	95.25 [3.750]	72	5821950-7	

THIS DRAWING IS A CONTROLLED DOCUMENT.		DIN 9139 MCMMASTER	OSJANOS	Tyco Electronics Corporation Harrisburg, PA 17105-3608
DIMENSIONS: mm [INCHES]		CHK M.YFOMANS	OSJANOS	
TOLERANCES UNLESS OTHERWISE SPECIFIED:		APVD M.YFOMANS		NAME
0 PLC ± -	1 PLC ± -	PRODUCT SPEC		CONNECTOR, MICRO-EDGE, .050, LP, GOLD PLATING
2 PLC ± -	3 PLC ± 0.13 [.005]	APPLICATION SPEC		SIZE
4 PLC ± -	ANGLES ± -	WEIGHT		CAGE CODE
MATERIAL		FINISH		DRAWING NO
1 2		3 4 5		A1 00779 C=5821950
CUSTOMER DRAWING				RESTRICTED TO
SCALE 1:1				SHEET 1 OF 1
				REV C