



DXTP19020DP5

20V PNP HIGH GAIN TRANSISTOR
PowerDI[®]5

Features

- 43% smaller than SOT223; 60% smaller than TO252
- Maximum height just 1.1mm
- Rated up to 1.3W
- $V_{CE0} = -20V$
- $I_C = -8A$; $I_{CM} = -15A$
- Low Saturation voltage, high gain transistor
- **Lead, Halogen and Antimony Free, RoHS Compliant (Note 1)**
- **“Green” Device (Note 2)**

Applications

- Load disconnect switch
- Battery charging

Mechanical Data

- Case: PowerDI[®]5
- Case Material: Molded Plastic, “Green” Molding Compound. UL Flammability Classification Rating 94V-0
- Moisture Sensitivity: Level 1 per J-STD-020
- Terminals: Finish – Matte Tin annealed over Copper leadframe. Solderable per MIL-STD-202, Method 208 ^{Ⓒ3}
- Weight: 0.093 grams (approximate)

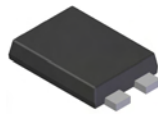

Top View

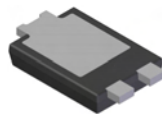

Bottom View

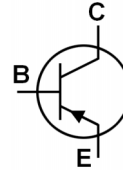

Device Schematic

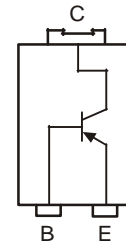

Pin-out diagram

Ordering Information (Note 3)

Part Number	Case	Packaging
DXTP19020DP5-13	PowerDI [®] 5	5000/Tape & Reel

- Notes:
1. No purposefully added lead. Halogen and Antimony Free.
 2. Diodes Inc's “Green” Policy can be found on our website at <http://www.diodes.com>
 3. For packaging details, go to our website at <http://www.diodes.com/datasheets/ap02007.pdf>.

Marking Information

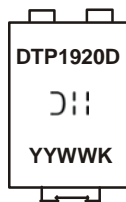

DTP1920D = Product Type Marking Code
 Ⓜ = Manufacturers' Code Marking
 K = Factory Designator
 YYWW = Date Code Marking
 YY = Last Two Digits of Year (ex: 09 for 2009)
 WW = Week code (01 to 53)

PowerDI is a registered trademark of Diodes Incorporated.

Maximum Ratings @T_A = 25°C unless otherwise specified

Characteristic	Symbol	Value	Unit
Collector-Base Voltage	V _{CBO}	-25	V
Collector-Emitter Voltage	V _{CEO}	-20	V
Emitter-Collector Voltage (Reverse Blocking)	V _{ECO}	-4	V
Emitter-Base Voltage	V _{EBO}	-7	V
Continuous Collector Current	I _C	-8	A
Base Current	I _B	-1	A
Peak Pulse Current	I _{CM}	-15	A

Thermal Characteristics

Characteristic	Symbol	Value	Unit
Power Dissipation @ T _A = 25°C (Note 4)	P _D	1.3	W
Thermal Resistance, Junction to Ambient Air (Note 4) @T _A = 25°C	R _{θJA}	96.1	°C/W
Power Dissipation @ T _A = 25°C (Note 5)	P _D	3	W
Thermal Resistance, Junction to Ambient Air (Note 5) @T _A = 25°C	R _{θJA}	41.7	°C/W
Operating and Storage Temperature Range	T _J , T _{STG}	-55 to +150	°C

Notes: 4. Device mounted on FR-4 PCB, 2 oz. copper, minimum recommended pad layout.
5. Device mounted on FR-4 PCB, 2 oz. copper, collector pad dimensions 0.42inch².

Electrical Characteristics @T_A = 25°C unless otherwise specified

Characteristic	Symbol	Min	Typ	Max	Unit	Test Condition
Collector-Base Breakdown Voltage	V _{(BR)CBO}	-25	-55	—	V	I _C = -100μA
Collector-Emitter Breakdown Voltage (Note 6)	V _{(BR)CEO}	-20	-50	—	V	I _C = -10mA
Emitter-Collector Breakdown Voltage (Reverse Blocking)	V _{(BR)ECX}	-4	-8.6	—	V	I _E = -100μA, R _{BC} < 1kΩ or 0.25V > V _{CB} > -0.25V
Emitter-Base Breakdown Voltage (Reverse Blocking)	V _{(BR)ECO}	-4	-8.6	—	V	I _E = -100μA
Emitter-Base Breakdown Voltage	V _{(BR)EBO}	-7	-8.2	—	V	I _E = -100μA
Collector Cutoff Current	I _{CBO}	—	<1	50	nA	V _{CB} = -25V
Emitter Cutoff Current	I _{EBO}	—	<1	-50	nA	V _{CB} = -25V, T _{amb} = 100 °C
Collector-Emitter Saturation Voltage (Note 6)	V _{CE(sat)}	—	-40 -97 -115 -145 -220	-47 -130 -145 -275	mV	I _C = -1A, I _B = -100mA I _C = -1A, I _B = -10mA I _C = -2A, I _B = -40mA I _C = -8A, I _B = -800mA
Base-Emitter Saturation Voltage (Note 6)	V _{BE(sat)}	—	-1050	-1150	mV	I _C = -8A, I _B = -800mA
Base-Emitter Turn-On Voltage (Note 6)	V _{BE(on)}	—	-930	-1000	mV	I _C = -8A, V _{CE} = -2V
DC Current Gain (Note 6)	h _{FE}	300 200 45 —	450 290 70 25	900 — — —	—	I _C = -100mA, V _{CE} = -2V I _C = -2A, V _{CE} = -2V I _C = -8A, V _{CE} = -2V I _C = -15A, V _{CE} = -2V
Transition Frequency	f _T	—	176	—	MHz	I _C = -50mA, V _{CE} = -10V, f = 50MHz
Input Capacitance (Note 6)	C _{ibo}	—	—	400	pF	V _{EB} = -0.5V, f = 1MHz
Output Capacitance (Note 6)	C _{obo}	—	36	45	pF	V _{CB} = -10V, f = 1MHz
Delay Time	t _d	—	23	—	ns	I _C = -1A, V _{CC} = -10V, I _{B1} = -I _{B2} = -50mA
Rise Time	t _r	—	18.4	—		
Storage Time	t _s	—	266	—		
Fall Time	t _f	—	49.6	—		

Notes: 6. Pulse Test: Pulse width ≤300μs. Duty cycle ≤2.0%.

PowerDI is a registered trademark of Diodes Incorporated.

Typical Characteristic

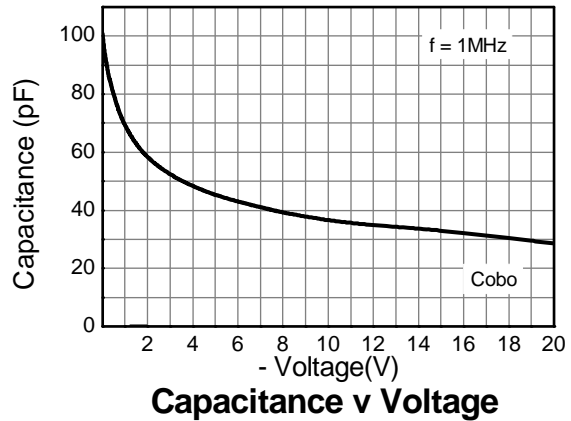
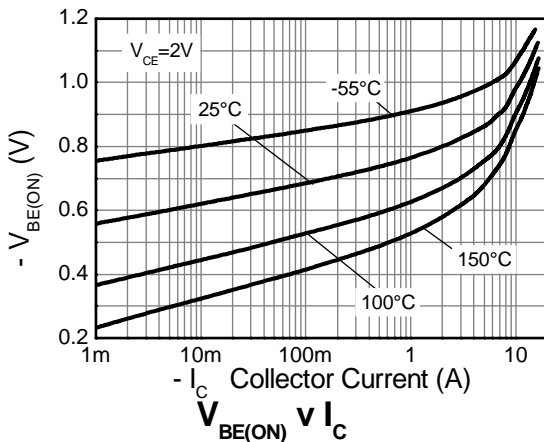
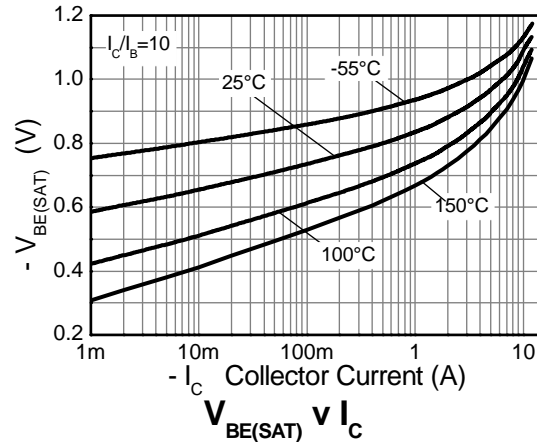
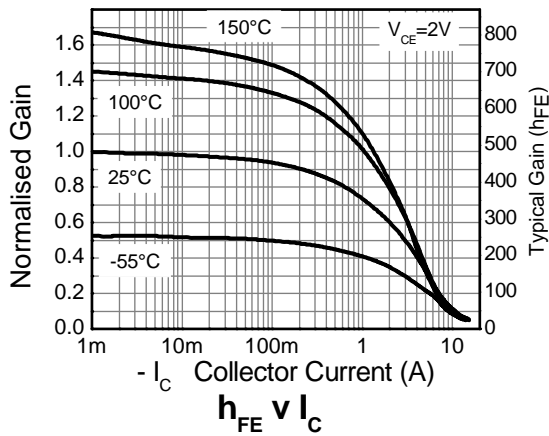
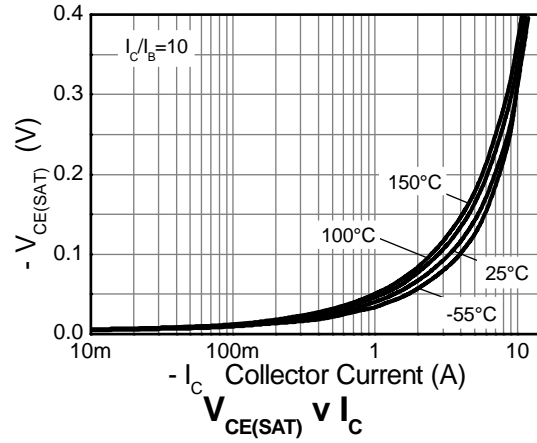
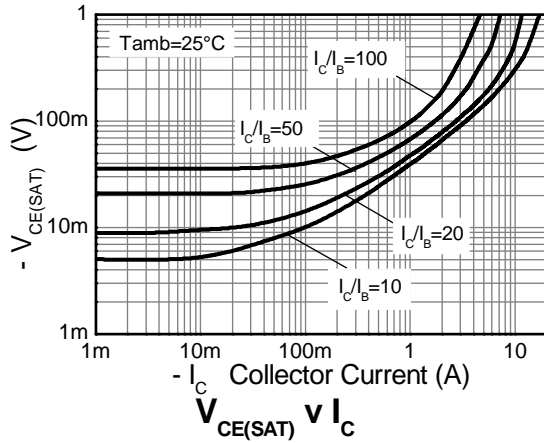

Package Outline Dimensions

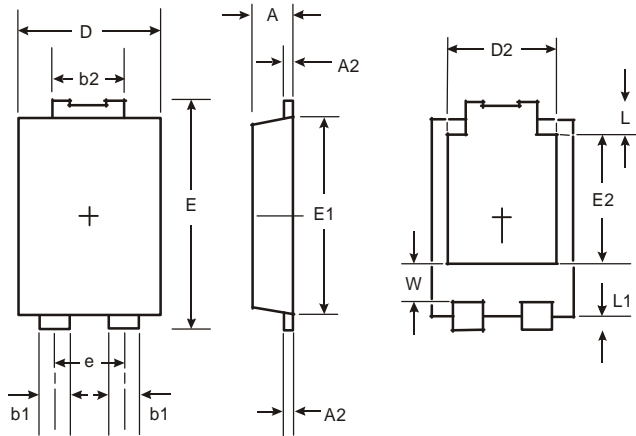

PowerDI ^{®5}		
Dim	Min	Max
A	1.05	1.15
A2	0.33	0.43
b1	0.80	0.99
b2	1.70	1.88
D	3.90	4.05
D2	3.054 Typ	
E	6.40	6.60
e	1.84 Typ	
E1	5.30	5.45
E2	3.549 Typ	
L	0.75	0.95
L1	0.50	0.65
W	1.10	1.41
All Dimensions in mm		

Suggested Pad Layout

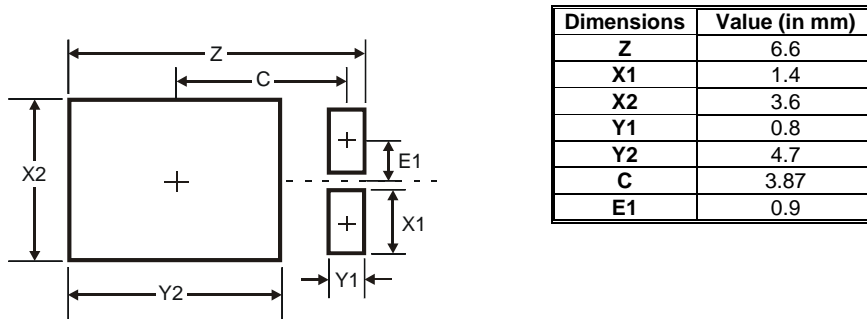

Dimensions	Value (in mm)
Z	6.6
X1	1.4
X2	3.6
Y1	0.8
Y2	4.7
C	3.87
E1	0.9

IMPORTANT NOTICE

DIODES INCORPORATED MAKES NO WARRANTY OF ANY KIND, EXPRESS OR IMPLIED, WITH REGARDS TO THIS DOCUMENT, INCLUDING, BUT NOT LIMITED TO, THE IMPLIED WARRANTIES OF MERCHANTABILITY AND FITNESS FOR A PARTICULAR PURPOSE (AND THEIR EQUIVALENTS UNDER THE LAWS OF ANY JURISDICTION).

Diodes Incorporated and its subsidiaries reserve the right to make modifications, enhancements, improvements, corrections or other changes without further notice to this document and any product described herein. Diodes Incorporated does not assume any liability arising out of the application or use of this document or any product described herein; neither does Diodes Incorporated convey any license under its patent or trademark rights, nor the rights of others. Any Customer or user of this document or products described herein in such applications shall assume all risks of such use and will agree to hold Diodes Incorporated and all the companies whose products are represented on Diodes Incorporated website, harmless against all damages.

Diodes Incorporated does not warrant or accept any liability whatsoever in respect of any products purchased through unauthorized sales channel. Should Customers purchase or use Diodes Incorporated products for any unintended or unauthorized application, Customers shall indemnify and hold Diodes Incorporated and its representatives harmless against all claims, damages, expenses, and attorney fees arising out of, directly or indirectly, any claim of personal injury or death associated with such unintended or unauthorized application.

Products described herein may be covered by one or more United States, international or foreign patents pending. Product names and markings noted herein may also be covered by one or more United States, international or foreign trademarks.

LIFE SUPPORT

Diodes Incorporated products are specifically not authorized for use as critical components in life support devices or systems without the express written approval of the Chief Executive Officer of Diodes Incorporated. As used herein:

A. Life support devices or systems are devices or systems which:

1. are intended to implant into the body, or
2. support or sustain life and whose failure to perform when properly used in accordance with instructions for use provided in the labeling can be reasonably expected to result in significant injury to the user.

B. A critical component is any component in a life support device or system whose failure to perform can be reasonably expected to cause the failure of the life support device or to affect its safety or effectiveness.

Customers represent that they have all necessary expertise in the safety and regulatory ramifications of their life support devices or systems, and acknowledge and agree that they are solely responsible for all legal, regulatory and safety-related requirements concerning their products and any use of Diodes Incorporated products in such safety-critical, life support devices or systems, notwithstanding any devices- or systems-related information or support that may be provided by Diodes Incorporated. Further, Customers must fully indemnify Diodes Incorporated and its representatives against any damages arising out of the use of Diodes Incorporated products in such safety-critical, life support devices or systems.

Copyright © 2009, Diodes Incorporated

www.diodes.com