



# NDUL03N150C

## N-Channel Power MOSFET 1500V, 2.5A, 10.5Ω, TO-3PF-3L

ON Semiconductor®

<http://onsemi.com>

### Features

- ON-resistance  $R_{DS(on)}=8\Omega$  (typ.)
- Input capacitance  $C_{iss}=650\text{pF}$  (typ.)
- 10V drive

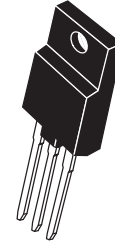

TO-3PF-3L

### Specifications

#### Absolute Maximum Ratings at $T_a=25^\circ\text{C}$

Parameter	Symbol	Conditions	Ratings	Unit
Drain to Source Voltage	$V_{DSS}$		1500	V
Gate to Source Voltage	$V_{GSS}$		$\pm 30$	V
Drain Current (DC)	$I_D$	Limited only maximum temperature $T_{ch}=150^\circ\text{C}$	2.5	A
Drain Current (Pulse)	$I_{DP}$	$PW \leq 10\mu\text{s}$ , duty cycle $\leq 1\%$	5	A
Allowable Power Dissipation	PD		3.0	W
		$T_c=25^\circ\text{C}$	50	W
Channel Temperature	$T_{ch}$		150	$^\circ\text{C}$
Storage Temperature	$T_{stg}$		-55 to +150	$^\circ\text{C}$
Avalanche Energy (Single Pulse) *1	$E_{AS}$		34	mJ
Avalanche Current *2	$I_{AV}$		2.5	A

Note : \*1  $V_{DD}=50\text{V}$ ,  $L=10\text{mH}$ ,  $I_{AV}=2.5\text{A}$  (Fig.1)\*2  $L \leq 10\text{mH}$ , single pulse

Stresses exceeding Maximum Ratings may damage the device. Maximum Ratings are stress ratings only. Functional operation above the Recommended Operating Conditions is not implied. Extended exposure to stresses above the Recommended Operating Conditions may affect device reliability.

#### Electrical Characteristics at $T_a=25^\circ\text{C}$

Parameter	Symbol	Conditions	Ratings			Unit
			min	typ	max	
Drain to Source Breakdown Voltage	$V_{(BR)DSS}$	$I_D=10\text{mA}$ , $V_{GS}=0\text{V}$	1500			V
Zero-Gate Voltage Drain Current	$I_{DSS}$	$V_{DS}=1200\text{V}$ , $V_{GS}=0\text{V}$			1	mA
Gate to Source Leakage Current	$I_{GSS}$	$V_{GS}=\pm 30\text{V}$ , $V_{DS}=0\text{V}$			$\pm 100$	nA
Cutoff Voltage	$V_{GS(off)}$	$V_{DS}=10\text{V}$ , $I_D=1\text{mA}$	2		4	V
Forward Transfer Admittance	$ y_{fs} $	$V_{DS}=20\text{V}$ , $I_D=1.25\text{A}$		1.9		S
Static Drain to Source On-State Resistance	$R_{DS(on)}$	$I_D=1.25\text{A}$ , $V_{GS}=10\text{V}$		8	10.5	$\Omega$
Input Capacitance	$C_{iss}$	$V_{DS}=30\text{V}$ , $f=1\text{MHz}$		650		pF
Output Capacitance	$C_{oss}$				70	pF
Reverse Transfer Capacitance	$C_{rss}$				20	pF
Turn-ON Delay Time	$t_{d(on)}$		See Fig.2		15	
Rise Time	$t_r$				24	ns
Turn-OFF Delay Time	$t_{d(off)}$				140	ns
Fall Time	$t_f$				47	ns
Total Gate Charge	$Q_g$	$V_{DS}=200\text{V}$ , $V_{GS}=10\text{V}$ , $I_D=2.5\text{A}$		34		nC
Gate to Source Charge	$Q_{gs}$				4.7	nC
Gate to Drain "Miller" Charge	$Q_{gd}$				15	nC
Diode Forward Voltage	$V_{SD}$	$I_S=2.5\text{A}$ , $V_{GS}=0\text{V}$		0.8	1.5	V
Reverse Recovery Time	$t_{rr}$	See Fig.3		350		ns
Reverse Recovery Charge	$Q_{rr}$	$I_S=2.5\text{A}$ , $V_{GS}=0\text{V}$ , $di/dt=100\text{A}/\mu\text{s}$		2220		nC

### ORDERING INFORMATION

See detailed ordering and shipping information on page 4 of this data sheet.

# NDUL03N150C

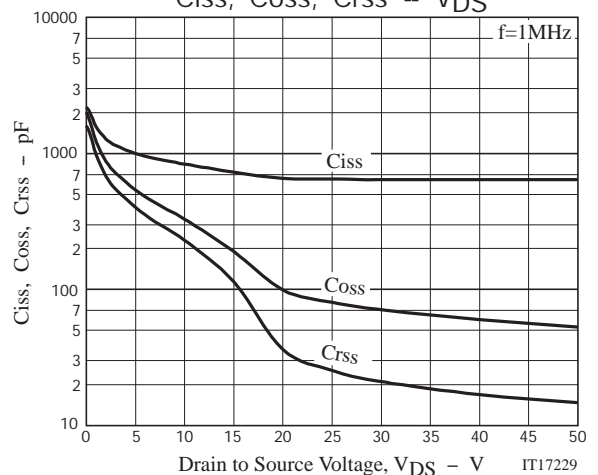
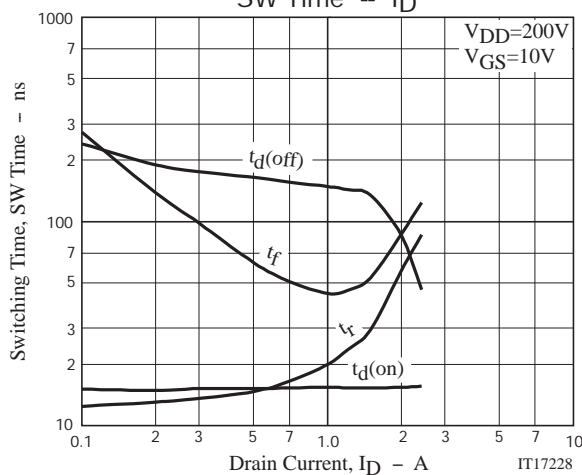
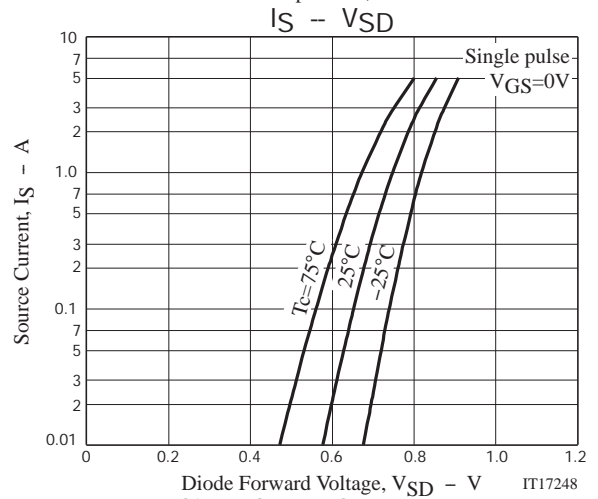
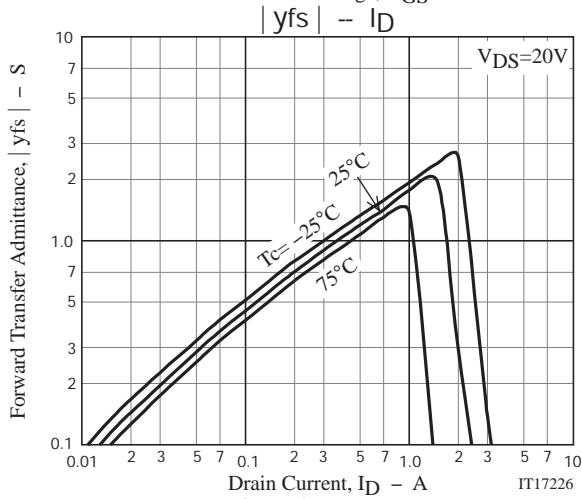
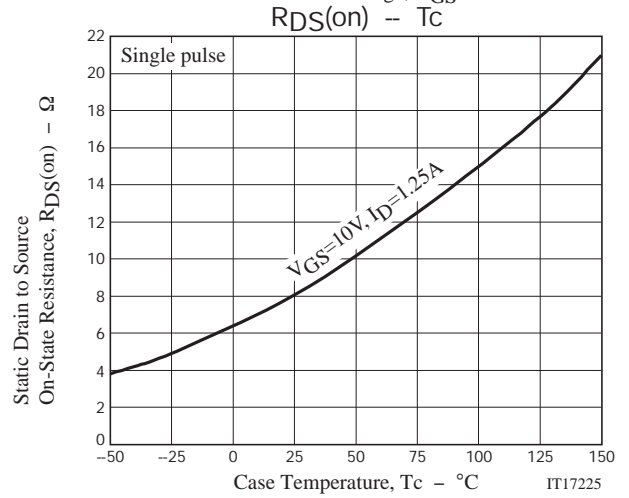
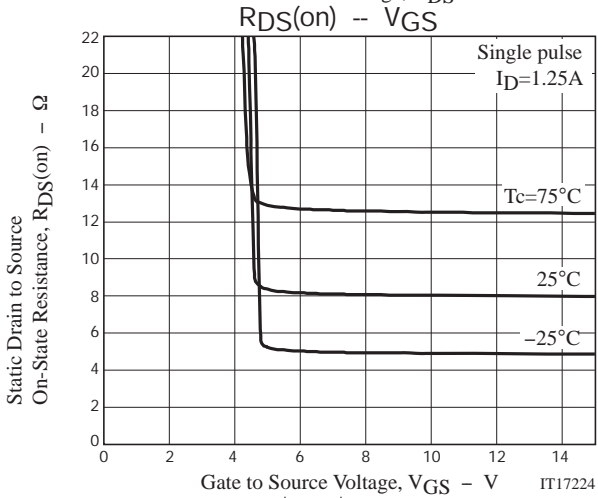
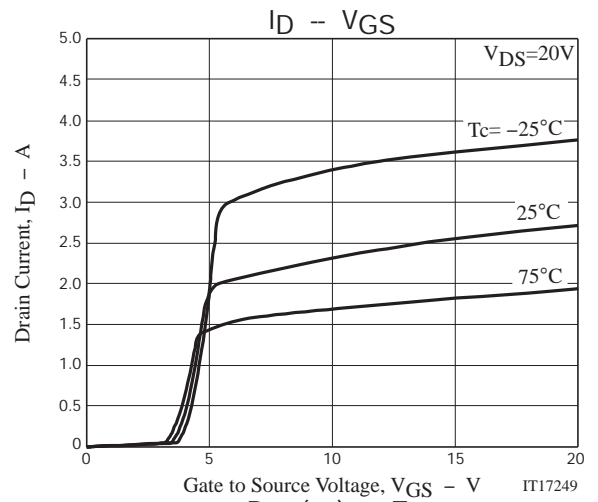
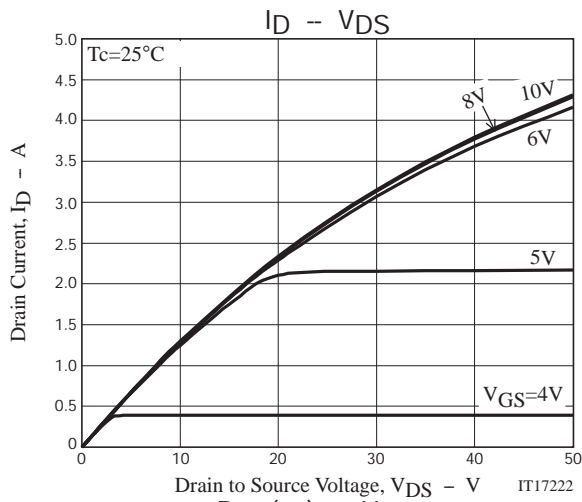

# NDUL03N150C

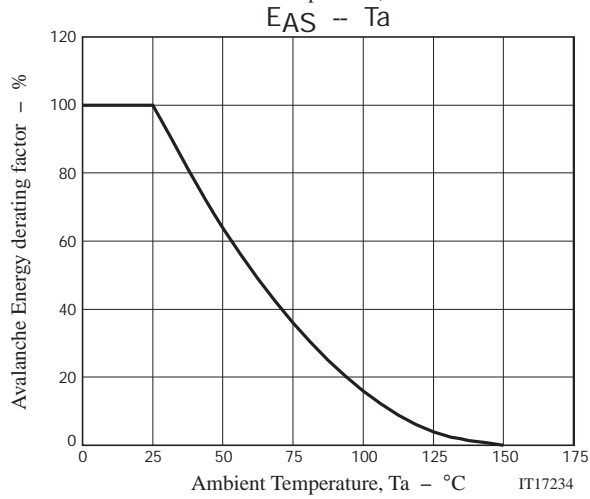
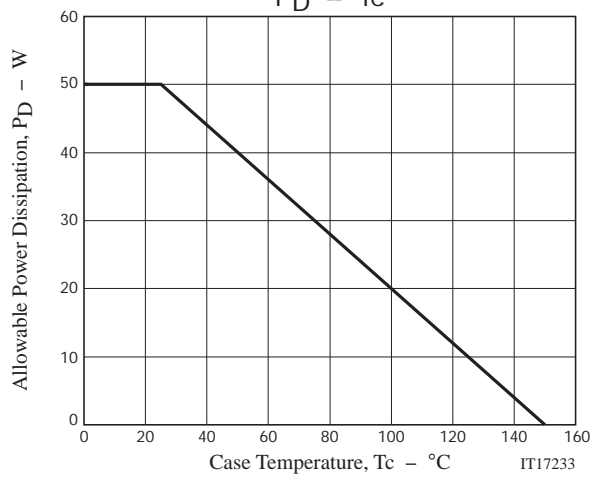
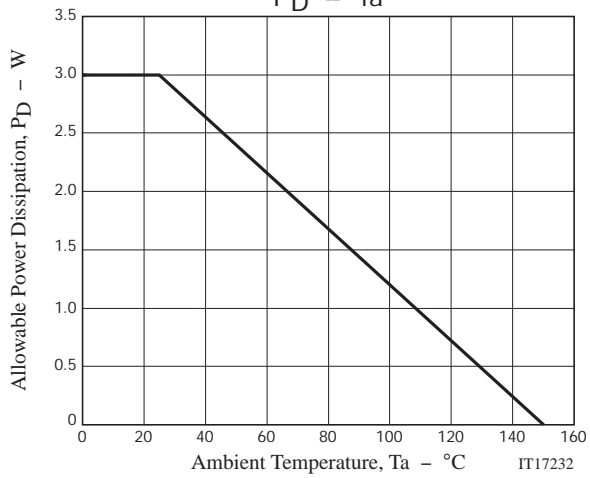
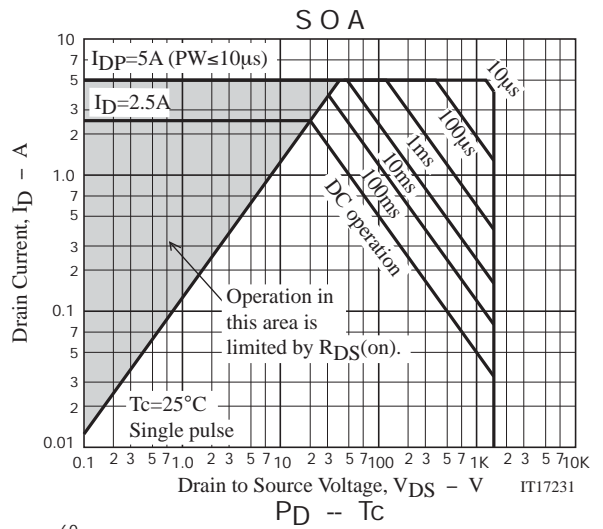
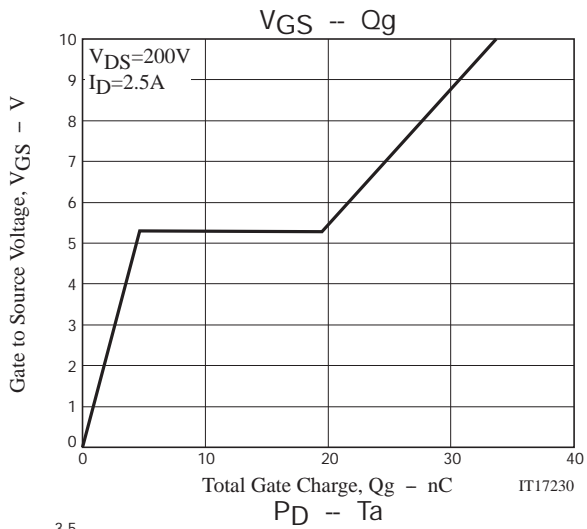

# NDUL03N150C

## Package Dimensions

NDUL03N150CG

TO-3PF-3L

CASE 340AH

ISSUE O

Unit : mm

1: Gate

2: Drain

3: Source

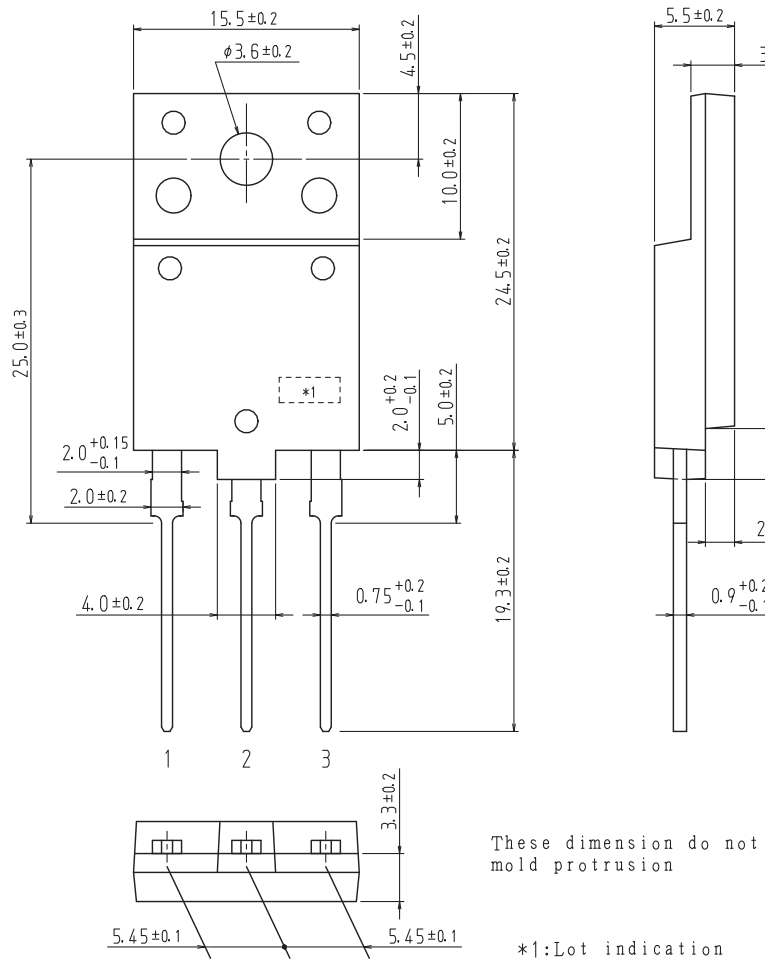

## Ordering & Package Information

Device	Package	Shipping	memo
NDUL03N150CG	TO-3PF-3L SC-94	30 pcs./tube	Pb-Free

## Marking

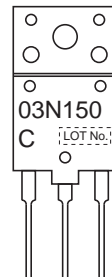

## Electrical Connection

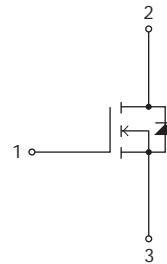

# NDUL03N150C

**Fig.1 Unclamped Inductive Switching Test Circuit**

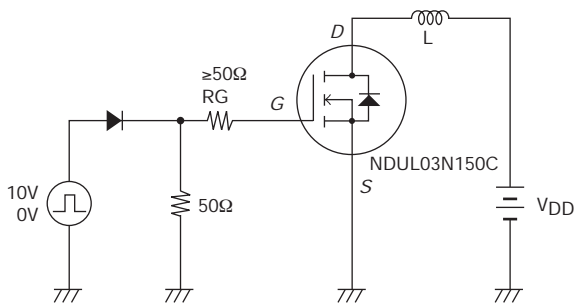

**Fig.2 Switching Time Test Circuit**

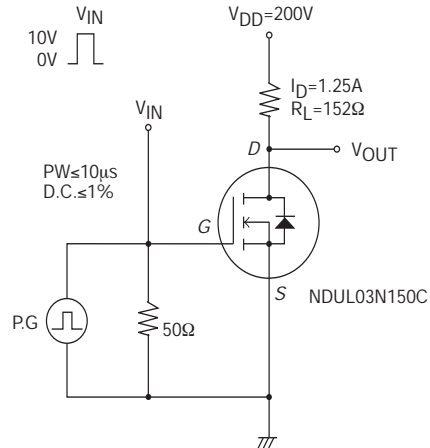

**Fig.3 Reverse Recovery Time Test Circuit**

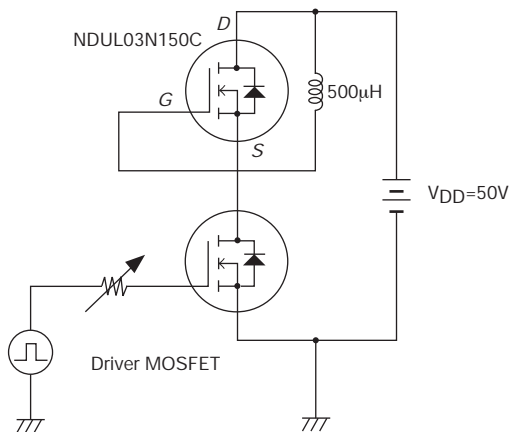

Note on usage : Since the NDUL03N150C is a MOSFET product, please avoid using this device in the vicinity of highly charged objects.

ON Semiconductor and the ON logo are registered trademarks of Semiconductor Components Industries, LLC (SCILLC). SCILLC owns the rights to a number of patents, trademarks, copyrights, trade secrets, and other intellectual property. A listing of SCILLC's product/patent coverage may be accessed at [www.onsemi.com/site/pdf/Patent-Marking.pdf](http://www.onsemi.com/site/pdf/Patent-Marking.pdf). SCILLC reserves the right to make changes without further notice to any products herein. SCILLC makes no warranty, representation or guarantee regarding the suitability of its products for any particular purpose, nor does SCILLC assume any liability arising out of the application or use of any product or circuit, and specifically disclaims any and all liability, including without limitation special, consequential or incidental damages. "Typical" parameters which may be provided in SCILLC data sheets and/or specifications can and do vary in different applications and actual performance may vary over time. All operating parameters, including "Typicals" must be validated for each customer application by customer's technical experts. SCILLC does not convey any license under its patent rights nor the rights of others. SCILLC products are not designed, intended, or authorized for use as components in systems intended for surgical implant into the body, or other applications intended to support or sustain life, or for any other application in which the failure of the SCILLC product could create a situation where personal injury or death may occur. Should Buyer purchase or use SCILLC products for any such unintended or unauthorized application, Buyer shall indemnify and hold SCILLC and its officers, employees, subsidiaries, affiliates, and distributors harmless against all claims, costs, damages, and expenses, and reasonable attorney fees arising out of, directly or indirectly, any claim of personal injury or death associated with such unintended or unauthorized use, even if such claim alleges that SCILLC was negligent regarding the design or manufacture of the part. SCILLC is an Equal Opportunity/Affirmative Action Employer. This literature is subject to all applicable copyright laws and is not for resale in any manner.