

PQxxxEH01ZxH Series

Low Voltage Operation
Low Power-Loss Voltage Regulators

Features

1. Low voltage operation
(Minimum operating voltage: 2.35V)
2.5V input → available 1.5 to 1.8V output
2. Large output current type (I_o : 1A)
3. Low dissipation current
(Dissipation current at no load: MAX. 2mA)
Output OFF-state dissipation current: MAX. 5 μ A)
4. Low power-loss
5. Built-in overcurrent and overheat protection functions
6. TO-263 package
7. RoHS directive compliant

Applications

1. Peripheral equipment of personal computers
2. Power supplies for various electronic equipment such as DVD player or STB

Model Line-up

Output current (I_o)	Package type	Output voltage (V_o)		
		1.5V	1.8V	2.5V
1A	Taping	PQ015EH01ZPH	PQ018EH01ZPH	PQ025EH01ZPH
	Sleeve	PQ015EH01ZZH	PQ018EH01ZZH	PQ025EH01ZZH

Absolute Maximum Ratings

($T_a=25^\circ\text{C}$)

Parameter	Symbol	Rating	Unit
^{*1} Input voltage	V_{IN}	10	V
^{*1} Output control voltage	V_C	10	V
Output current	I_o	1	A
^{*2} Power dissipation	P_D	35	W
^{*3} Junction temperature	T_j	150	$^\circ\text{C}$
Operating temperature	T_{opr}	-40 to +85	$^\circ\text{C}$
Storage temperature	T_{stg}	-40 to +150	$^\circ\text{C}$
Soldering temperature	T_{sol}	260(10s)	$^\circ\text{C}$

^{*1} All are open except GND and applicable terminals.

^{*2} P_D : With infinite heat sink

^{*3} Overheat protection may operate at T_j : 125 $^\circ\text{C}$ to 150 $^\circ\text{C}$

Outline Dimensions

(Unit : mm)

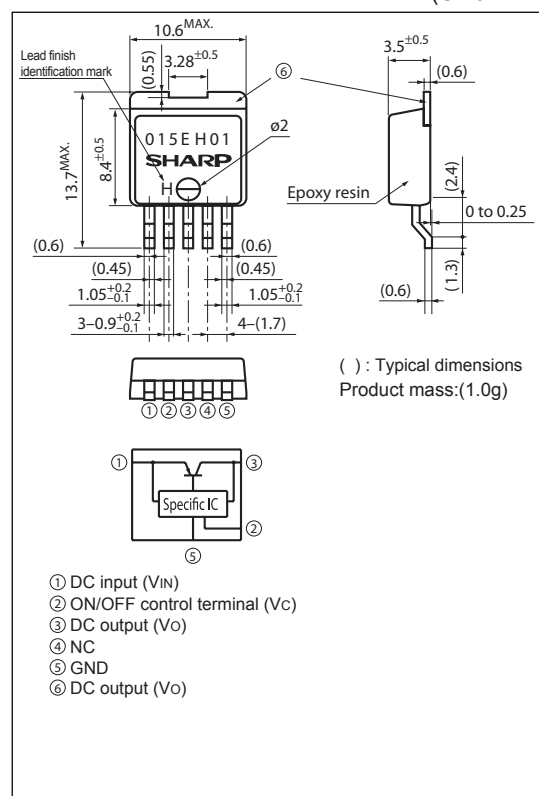

Lead finish:Lead-free solder plating
(Composition: Sn2Cu)

Notice The content of data sheet is subject to change without prior notice.

In the absence of confirmation by device specification sheets, SHARP takes no responsibility for any defects that may occur in equipment using any SHARP devices shown in catalogs, data books, etc. Contact SHARP in order to obtain the latest device specification sheets before using any SHARP device.

Electrical Characteristics

(Unless otherwise specified, condition shall be $V_{IN}=V_O(TYP)+1V$, $I_o=0.5A$, $V_c=2.7V$, $T_a=25^\circ C$)

Parameter	Symbol	Conditions	MIN.	TYP.	MAX.	Unit
Input voltage	V_{IN}	-	Refer to below table			V
Output voltage	V_O	-	Refer to below table			V
Load regulation	RegL	$I_o=5mA$ to 1A	-	0.2	2.0	%
Line regulation	Regl	$V_{IN}=V_O(TYP)+1V$ to $V_O(TYP)+6V$, $I_o=5mA$	-	0.1	1.0	%
Temperature coefficient of output voltage	TcV_O	$T_j=0$ to $+125^\circ C$, $I_o=5mA$	-	± 0.01	-	%/ $^\circ C$
Ripple rejection	RR	Refer to Fig.2	45	60	-	dB
*4 ON-state voltage for control	$V_{C(ON)}$	-	2.0	-	-	V
ON-state current for control	$I_{C(ON)}$	-	-	-	200	μA
OFF-state voltage for control	$V_{C(OFF)}$	-	-	-	0.8	V
OFF-state current for control	$I_{C(OFF)}$	$V_c=0.4V$	-	-	2	μA
Quiescent current	I_q	$I_o=0A$	-	1	2	mA
Output OFF-state consumption current	I_{qs}	$I_o=0A$, $V_c=0.4V$	-	-	5	μA

*4 In case of opening control terminal ②, output voltage turns off

Input voltage range

Model No.	Symbol	Conditions	MIN.	TYP.	MAX.	Unit
PQ015EH01ZxH	V_{IN}	$I_o=0.5A$, $V_c=2.7V$, $T_a=25^\circ C$	2.35	-	10	V
PQ018EH01ZxH			2.35	-	10	
PQ025EH01ZxH			3.0	-	10	

Output voltage

Model No.	Symbol	Conditions	MIN.	TYP.	MAX.	Unit
PQ015EH01ZxH	V_O	$V_{IN}=V_O(TYP)+1V$, $I_o=0.5A$, $V_c=2.7V$, $T_a=25^\circ C$	1.45	1.5	1.55	V
PQ018EH01ZxH			1.75	1.8	1.85	
PQ025EH01ZxH			2.438	2.5	2.562	

Fig.1 Test Circuit

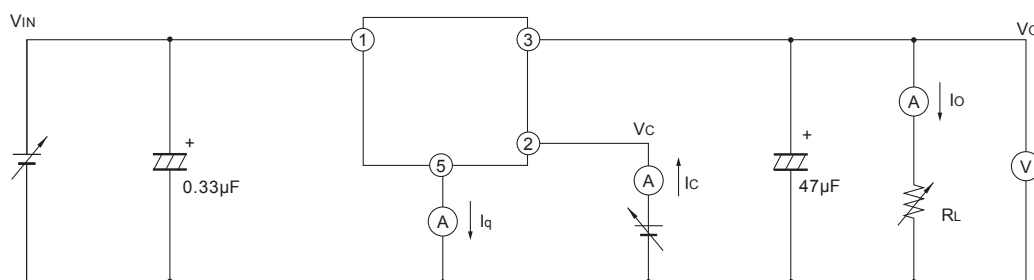

Fig.2 Test Circuit for Ripple Rejection

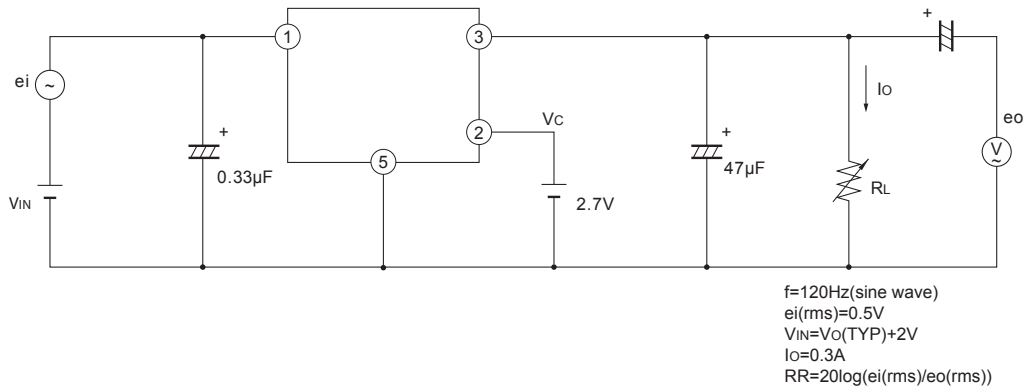

Fig.3 Power Dissipation vs. Ambient Temperature

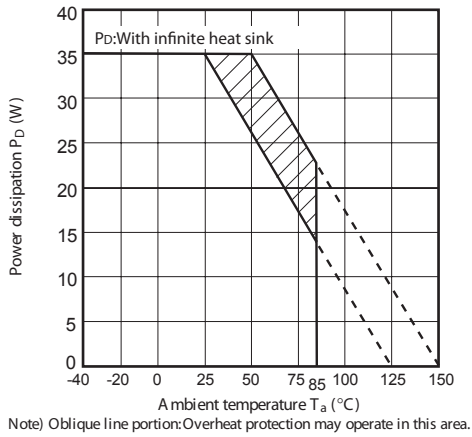

Fig.4 Overcurrent Protection Characteristics (Typical Value) (PQ015EH01ZxH)

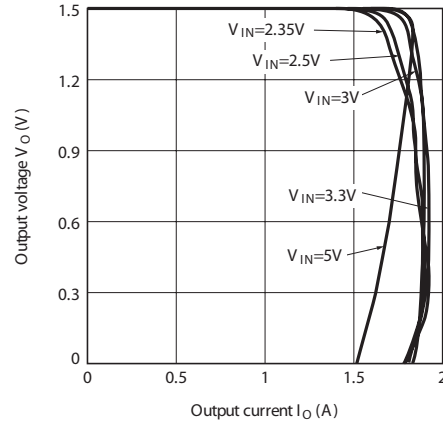

Fig.5 Overcurrent Protection Characteristics (Typical Value) (PQ018EH01ZxH)

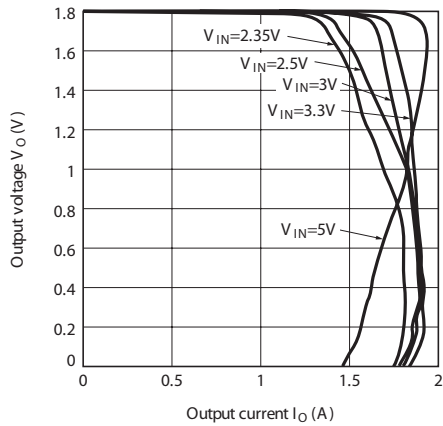

Fig.6 Overcurrent Protection Characteristics (Typical Value) (PQ025EH01ZxH)

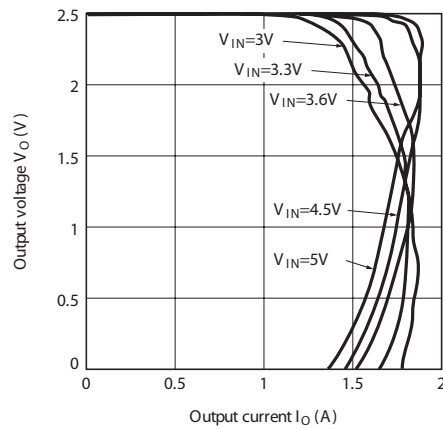

Fig.7 Output Voltage vs. Ambient Temperature (PQ015EH01ZxH)

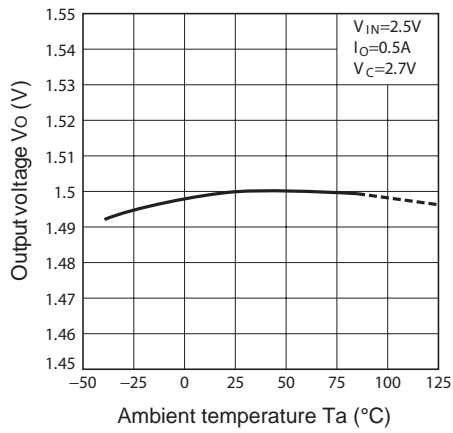

Fig.8 Output Voltage vs. Ambient Temperature (PQ018EH01ZxH)

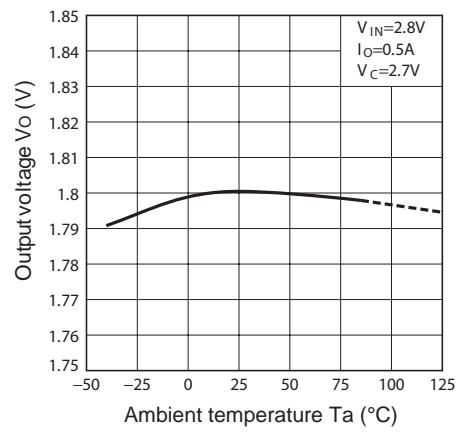

Fig.9 Output Voltage vs. Ambient Temperature (PQ025EH01ZxH)

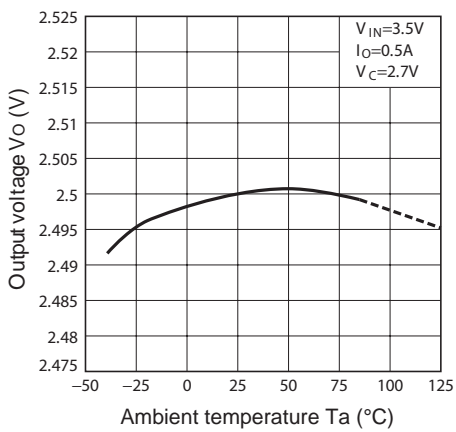

Fig.10 Output Voltage vs. Input Voltage (PQ015EH01ZxH)

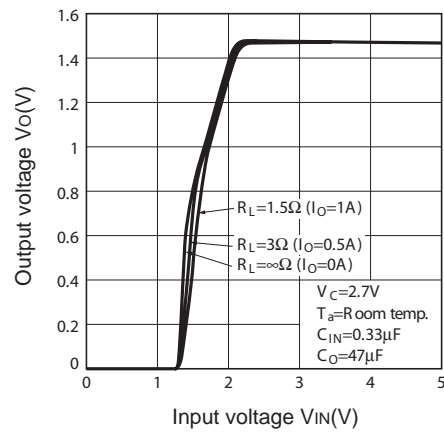

Fig.11 Output Voltage vs. Input Voltage (PQ018EH01ZxH)

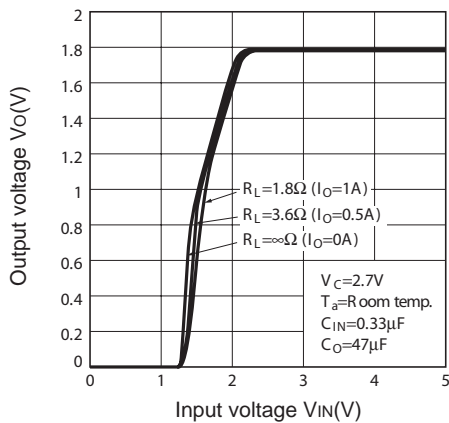

Fig.12 Output Voltage vs. Input Voltage (PQ025EH01ZxH)

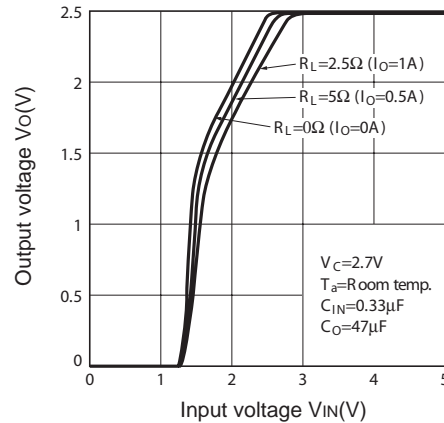

Fig.13 Circuit Operating Current vs. Input Voltage (PQ015EH01ZxH)

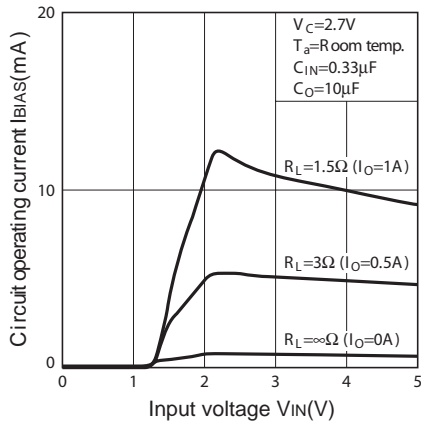

Fig.14 Circuit Operating Current vs. Input Voltage (PQ018EH01ZxH)

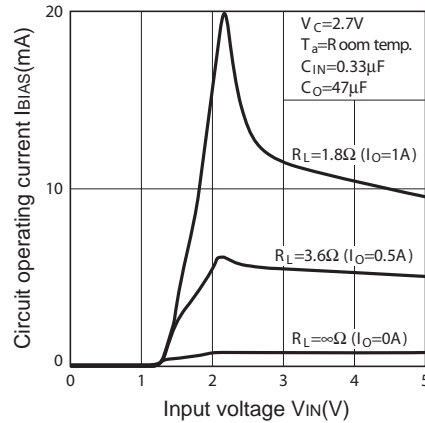

Fig.15 Circuit Operating Current vs. Input Voltage (PQ025EH01ZxH)

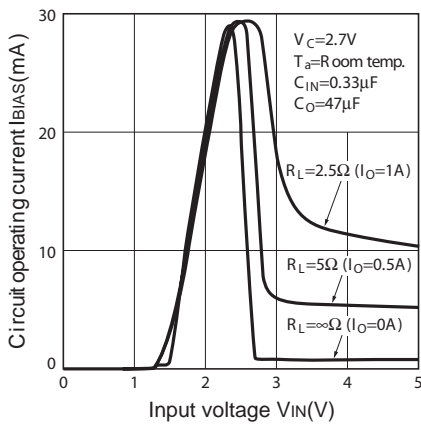

Fig.16 Quiescent Current vs. Junction Temperature

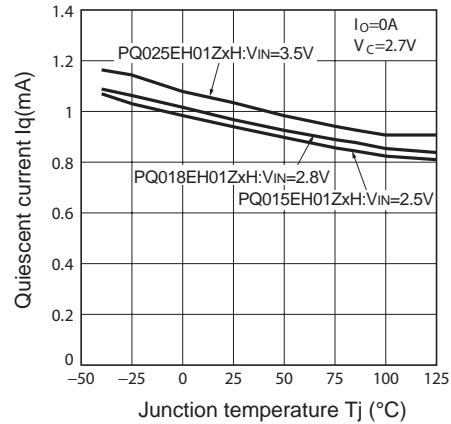

Fig.17 ON-OFF Threshold Voltage vs. Ambient Temperature (PQ018EH01ZxH)

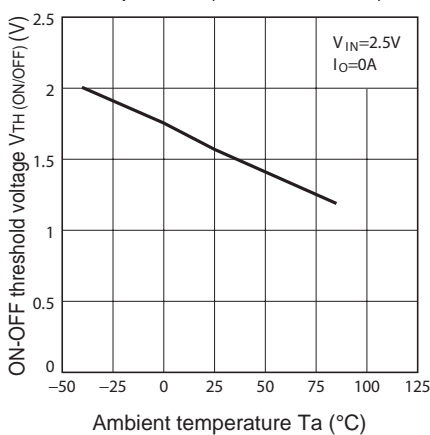

Fig.18 Ripple Rejection vs. Input Ripple Frequency

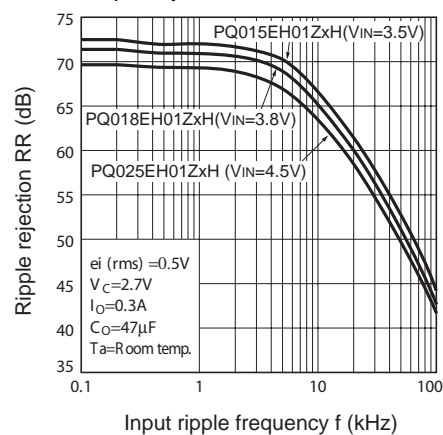

Fig.19 Ripple Rejection vs. Output Current

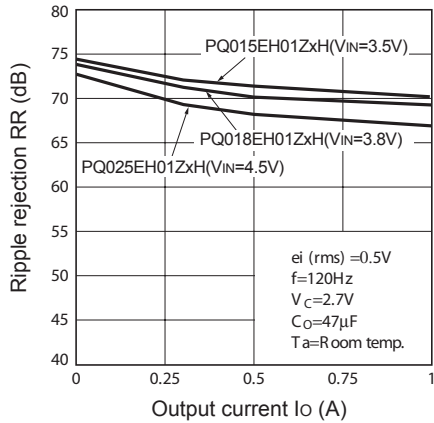
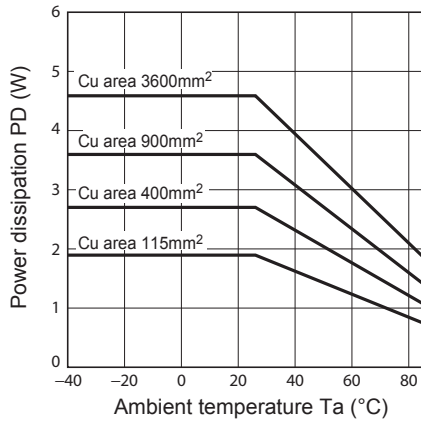
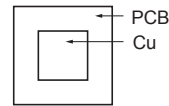

Fig.20 Power Dissipation vs. Ambient Temperature (Typical Value)



Mounting PCB



Material : Glass-cloth epoxy resin
 Size : 60×60×1.6mm
 Cu thickness : 65μm

Fig.21 Typical Application

