

ISL8240MEVAL4Z Dual 20A/Optional 40A Cascadable Evaluation Board Setup Procedure

The ISL8240MEVAL4Z is a complete, dual step-down switching mode DC/DC module. The dual outputs can easily be paralleled for single-output, high current use. It is easy to apply this high power, current sharing DC/DC power module to power hungry datacom, telecom and FPGA applications. All that is needed in order to have a complete, dual 20A design ready for use are the [ISL8240M](#), a few passive components and V_{OUT} setting resistors.

The simplicity of the ISL8240M is its off-the-shelf, unassisted implementation. Patented current sharing in multi phase operation greatly reduces ripple currents, BOM costs and complexity. The ISL8240M has a thermally enhanced, compact 17mmx17mmx7.5mm QFN package that operates at full load and over-temperature. Easy access to all pins, with few external components, reduces PCB design to a component layer and a simple ground layer.

This ISL8240MEVAL4Z evaluation board is designed for dual 20A output applications. Optionally, this board can easily be converted for 40A single output use. Multiple ISL8240MEVAL4Z boards can be cascaded through the SYNC and CLKOUT pins to operate with phase shifting, for paralleling or multiple output use. The input voltage of this board is 4.5V to 20V and the default outputs on this board are set at 1.0V and 1.5V.

Recommended Equipment

- 0V to 20V power supply with at least 5A source current capability
- Electronic load capable of sinking current up to 40A
- Digital Multimeters (DMMs)
- 100MHz quad-trace oscilloscope

Quick Start

For dual output operation, the inputs are BA7 (VIN1), BA8 (GND), BA3 (VIN2) and BA4 (GND). The outputs are BA5 (VOUT1), BA6 (GND), BA1 (VOUT2) and BA2 (GND).

For paralleled single output operation, the inputs are BA7 (VIN1) and BA8 (GND). The outputs are BA5 (VOUT1) and BA6 (GND) with BA5 and BA1 shorted.

Ordering Information

PART NUMBER	DESCRIPTION
ISL8240MEVAL4Z	Evaluation Board

References

- [ISL8240M](#) datasheet.

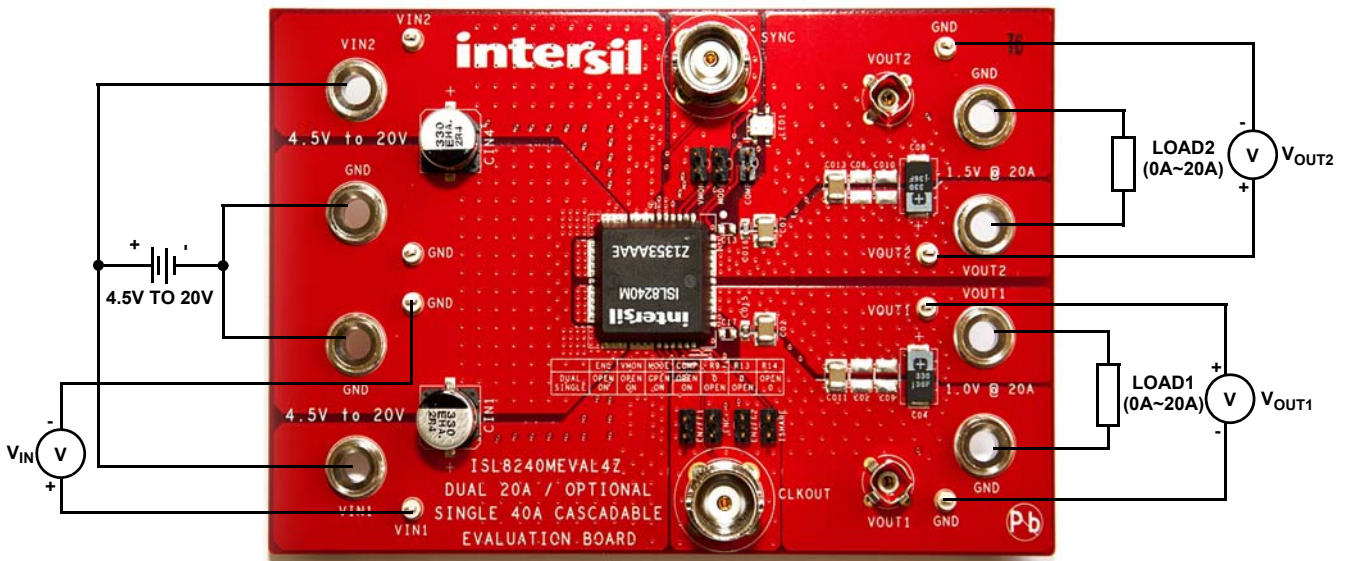

FIGURE 1. ISL8240MEVAL4Z BOARD IMAGE

Dual Output Mode

1. Connect a power supply capable of sourcing at least 5A to inputs BA7 (VIN1), BA8 (GND), BA3 (VIN2) and BA4 (GND) of the ISL8240MEVAL4Z evaluation board, with a voltage between 4.5V to 20V. VIN1 and VIN2 can be different with R₁₈ and R₁₉ open.
2. Connect an electronic load or device to be powered to the outputs BA5 (VOUT1), BA6 (GND), BA1 (VOUT2) and BA2 (GND) of the board. All connections, especially the low voltage, high current V_{OUT} lines, should be able to carry the desired load current and should be made as short as possible.
3. Make sure that the setup is connected correctly. Turn on the power supply. If the board is working properly, the green LED will illuminate; if not, the red LED will illuminate (recheck the wire/jumper connections in this case). Measure the output voltages, V_{OUT1}, which should be at 1.0V and V_{OUT2}, which should be at 1.5V.
4. If different output voltages are desired, board resistors can be exchanged to provide the desired V_{OUT}. Please refer to [Table 1](#) for R₂/R₄ resistor values, which can be used to produce different output voltages.

The switching frequency is set to 500kHz by default. The switching frequency can be adjusted, as recommended in [Table 1](#). By changing the resistor R_{FSET}, the desired frequency can be adjusted. If the output voltage is set to ≥1.5V, the output current will need to be derated at certain conditions to allow for safe operation. Please refer to the [ISL8240M](#) datasheet.

TABLE 1. VALUE OF BOTTOM RESISTOR (TOP RESISTOR R₁, R₃ = 1kΩ) AND FREQUENCY SELECTION FOR DIFFERENT OUTPUT VOLTAGES

V _{OUT} (V)	R ₂ /R ₄ (Ω)	FREQUENCY (kHz)	R _{FSET} (kΩ) (V _{IN} = 12V)
1.0	1500	500	237
1.2	1000	550	174
1.5	665	600	140
1.8	499	650	115
2.5	316	700	100

Optional Paralleled Single Output Mode

1. To set up the parallel mode, short JP1 (ENC), JP2 (VMON) and JP3 (COMP) with a jumper. To set up 180° interleaving phase between 2 channels, short the MODE pin and GND pin of JP6 with a jumper.
2. Remove R₉ and R₁₃. Change R₁₄ to 0Ω. Change R₁₈ and R₁₉ to 0Ω. Short VOUT1 to VOUT2 using short wires or copper straps. Add C₂ for a 470pF capacitor.
3. Connect a power supply capable of sourcing at least 5A to the inputs BA7 (VIN1), BA8 (GND), BA3 (VIN2) and BA4 (GND) of the ISL8240MEVAL4Z evaluation board, with a voltage between 4.5V to 20V. VIN1 and VIN2 need to be shorted together.

4. Connect an electronic load or the device to be powered to the outputs BA5 (VOUT1) and BA6 (GND) of the board. All connections, especially the low voltage, high current V_{OUT} lines, should be able to carry the desired load current and should be made as short as possible.
5. Make sure the setup is connected correctly prior to applying any power to the board. Adjust the power supply to 12V and turn on the input power supply. If the board is working properly, the green LED will illuminate; if not, the red LED will illuminate (recheck the wire/jumper connections in this case). Measure the output voltages, V_{OUT1}, which should be at 1.0V.
6. Apply any load that is less than 40A for normal steady state operation. Refer to [Table 1](#) to change the output voltage by changing resistor R₂.

TABLE 2. BOARD CONFIGURATION FOR SINGLE OUTPUT 40A APPLICATION

	ENC	VMON	MODE	COMP	R9	R13	R14
Dual	OPEN	OPEN	OPEN	OPEN	0	0	OPEN
Single	ON	ON	ON	ON	OPEN	OPEN	0

For optimized performance of a 2-phase single output application of the ISL8240M, please refer to application note [AN1923](#).

Optional Cascadable Mode

Cascadable mode is needed when multiple evaluation boards are used for paralleling or multiple output use. Follow the steps shown below:

1. In order to generate CLKOUT at a shifted phase clock signal, the control loop of VOUT2 needs to be disabled by connecting VSEN2- to VCC.
2. Program MODE and VSEN2+ pin voltages to set the CLKOUT signal and the shifted degrees between two phases on the board (refer to [Table 3](#) on [page 4](#)).
3. Use a coaxial cable to connect CLKOUT (J5) to SYNC (J2) of the next evaluation board, which can be programmed for parallel or dual output use.
4. If the second board is programmed for parallel use, the ISHARE pins of the first and second boards need to be tied together. Using two twisted wires, short two different jumpers of JP7 (ISHARE/SGND) on two evaluation boards. Add 1nF capacitors of C₁₄ for different boards to decouple the noise.
5. If the third board is used in cascadable mode, the second board can only be used in the parallel mode to generate the CLKOUT signal for the SYNC pin on the third board.
6. Follow the instructions from Steps 1 through 5 for more cascadable boards.

Evaluation Board Information

The evaluation board size is 114.3mmx76.2mm. It is a 4-layer board, containing 2-ounce copper on the top and bottom layers and 2-ounce copper on all internal layers. The board can be used as a dual 20A reference design. Refer to "[Layout](#)" on page 6. The board is made of FR4 material and all components, including the solder attachment, are lead-free.

Thermal Considerations and Current Derating

For high current applications, board layout is very critical in order to make the module operate safely and deliver maximum allowable power. To carry large currents, the board layout needs to be designed carefully to maximize thermal performance. To achieve this, use sufficient trace width, copper weight and the proper connectors.

This evaluation board is designed for running dual 20A at room temperature without additional cooling systems needed. However, if the output voltage is increased or the board is operated at elevated temperatures, then the available current is derated. Refer to the derated current curves in the [ISL8240M](#) datasheet to determine the output current available.

For layout of designs using the ISL8240M, the thermal performance can be improved by adhering to the following design tips:

1. Use the top and bottom layers to carry the large current. VOUT1, VOUT2, Phase 1, Phase 2, PGND, VIN1 and VIN2 should have large, solid planes. Place enough thermal vias to connect the power planes in different layers under and around the module.
2. Phase 1 and Phase 2 pads are switching nodes that generate switching noise. Keep these pads under the module. For noise-sensitive applications, it is recommended to keep phase pads only on the top and inner layers of the PCB; do not place phase pads exposed to the outside on the bottom layer of the PCB. To improve the thermal performance, the phase pads can be extended in the inner layer, as shown in Phase 1 and Phase 2 pads on layer 2 ([Figure 5](#)) for this dual 20A evaluation board. Make sure that layer 1 and layer 3 have the GND layers to cover the extended areas of phase pads at layer 2 to avoid noise coupling.
3. Place the modules evenly on the board and leave enough space between modules. If the board space is limited, try to put the modules with low power loss closely together (i.e. low V_{OUT} or I_{OUT}) while still separating the module with high power loss.
4. If the ambient temperature is high or the board space is limited, airflow is needed to dissipate more heat from the modules. A heatsink can also be applied to the top side of the module to further improve the thermal performance (heatsink recommendation: Aavid Thermalloy, part number 375424B00034G, www.aavid.com).

Application Note 1922

TABLE 3. ISL8240M OPERATION MODES

1ST MODULE (I = INPUT; O = OUTPUT; I/O = INPUT AND OUTPUT, BI-DIRECTION)										MODES OF OPERATION		OUTPUT (see Description for details)
MODE	EN1/FF1 (I)	EN2/FF2 (I)	VSEN2- (I)	MODE (I)	VSEN2+ (I)	CLKOUT/REFIN WRT 1 ST (I OR O)	VMON2 (Note 2)	VMON1 OF 2 ND MODULE (Note 2)	2 ND CHANNEL WRT 1 ST (O) (Note 1)	OPERATION MODE OF 2 ND MODULE	OPERATION MODE OF 3 RD MODULE	
1	0	0	-	-	-	-	-	-	-	-	-	Disabled
2A	0	1	Active	Active	Active	-	Active	-	VMON1 = VMON2 to Keep PGOOD Valid	-	-	Single Phase
2B	1	0	-	-	-	-	-	-	VMON1 = VMON2 to Keep PGOOD Valid	-	-	Single Phase
3A	1	1	<V _{CC} -0.7V	Active	Active	29% to 45% of V _{CC} (I)	Active	-	0°	-	-	Dual Regulator
3B	1	1	<V _{CC} -0.7V	Active	Active	45% to 62% of V _{CC} (I)	Active	-	90°	-	-	Dual Regulator
3C	1	1	<V _{CC} -0.7V	Active	Active	>62% of V _{CC} (I)	Active	-	180°	-	-	Dual Regulator
4	1	1	<V _{CC} -0.7V	Active	Active	<29% of V _{CC} (I)	Active	-	-60°	-	-	DDR Mode
5A	1	1	V _{CC}	GND	-	60°	VMON1 or Divider	-	180°	-	-	2-Phase
5B	1	1	V _{CC}	GND	-	60°	Divider	Divider	180°	5B	5B	6-Phase
5C	1	1	V _{CC}	GND	-	60°	VMON1 or Divider	Active	180°	5C	5C	3 Outputs
6	1	1	V _{CC}	V _{CC}	GND	120°	1kΩ	Active	240°	2B	-	3-Phase
7A	1	1	V _{CC}	V _{CC}	V _{CC}	90°	1kΩ	Divider	180°	7A	-	4-Phase
7B	1	1	V _{CC}	V _{CC}	V _{CC}	90°	1kΩ	Active	180°	7B	-	2 Outputs (1 st module in Mode 7A)
7C	1	1	V _{CC}	V _{CC}	V _{CC}	90°	1kΩ	Active	180°	3, 4	-	3 Outputs (1 st module in Mode 7A)
8	Cascaded Module Operation MODEs 5B+5B+7A+5B+5B+5B/7A, No External Clock Required											12-Phase
9	External Clock or External Logic Circuits Required for Equal Phase Interval											5, 7, 8, 9, 10, 11, or (PHASE >12)

NOTES:

1. "2ND CHANNEL WRT 1ST" means "second channel with respect to first;" in other words, Channel 2 lags Channel 1 by the degrees specified in this column. For example, 90° means Channel 2 lags Channel 1 by 90°; -60° means Channel 2 leads Channel 1 by 60°.
2. "VMON1" means that the pin is tied to the VMON1 pin of the same module.
 "Divider" means that there is a resistor divider from VOUT to SGND; refer to Figure 25 in the [ISL8240M](#) datasheet.
 "1kΩ" means that there is a 1kΩ resistor connecting the pin to SGND; refer to Figure 23 in the [ISL8240M](#) datasheet.

ISL8240MEVAL4Z Board Schematic

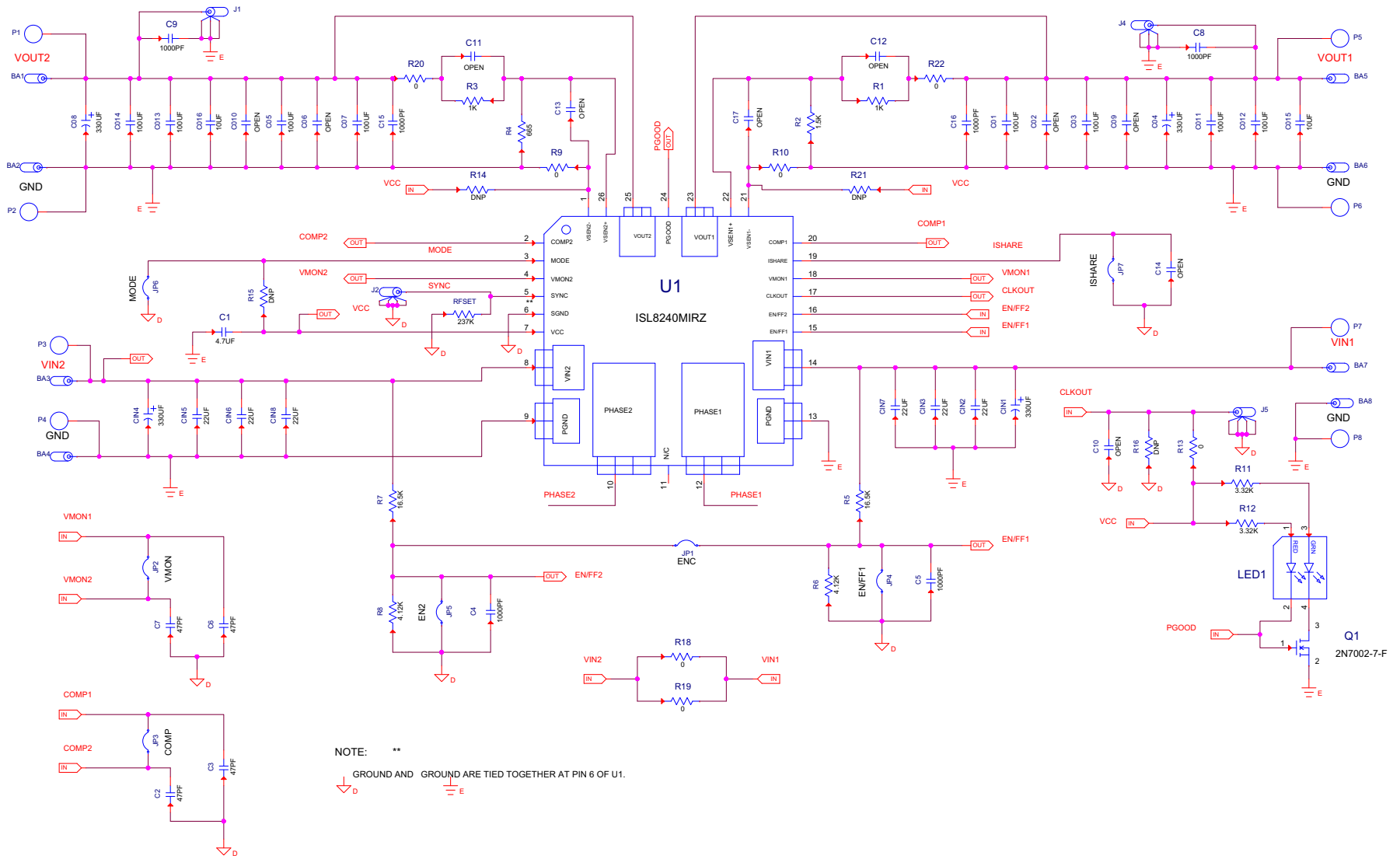

NOTE: **
GROUND AND GROUND ARE TIED TOGETHER AT PIN 6 OF U1.

FIGURE 2. ISL8240MEVAL4Z BOARD SCHEMATIC

Layout

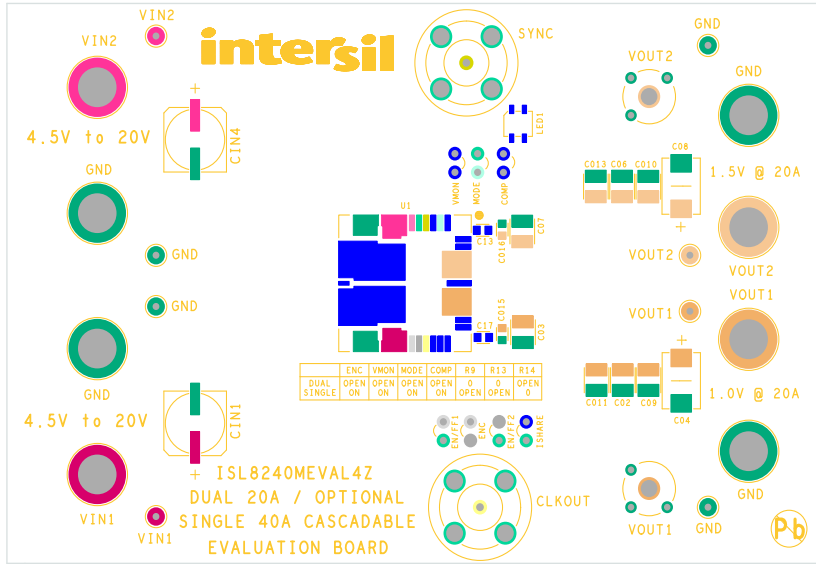

FIGURE 3. TOP SILKSCREEN

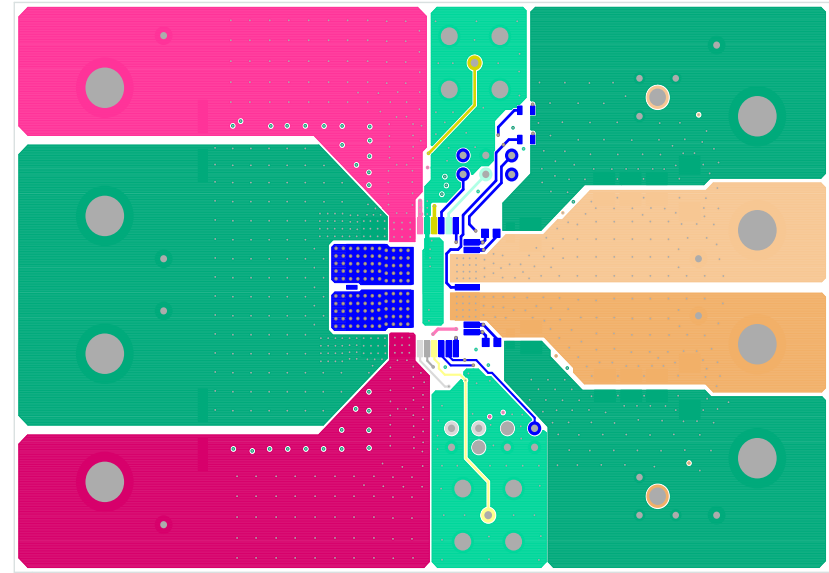

FIGURE 4. TOP LAYER COMPONENT SIDE

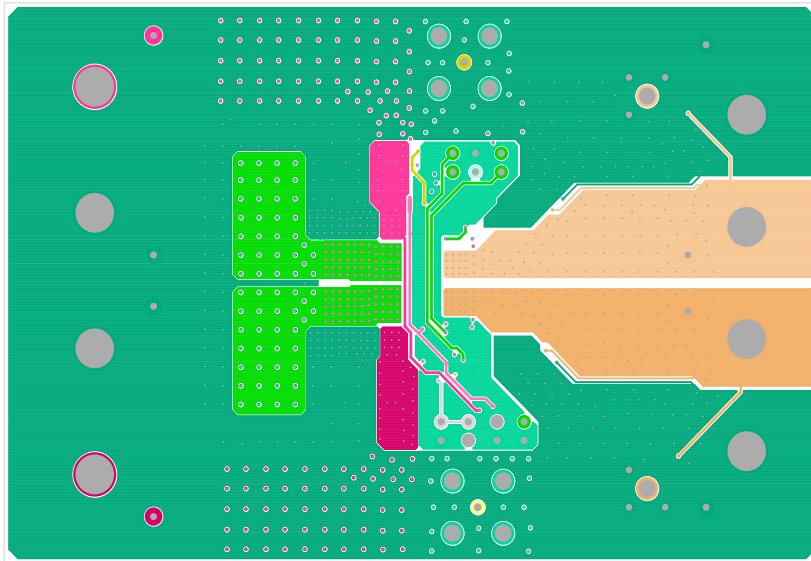

FIGURE 5. LAYER 2

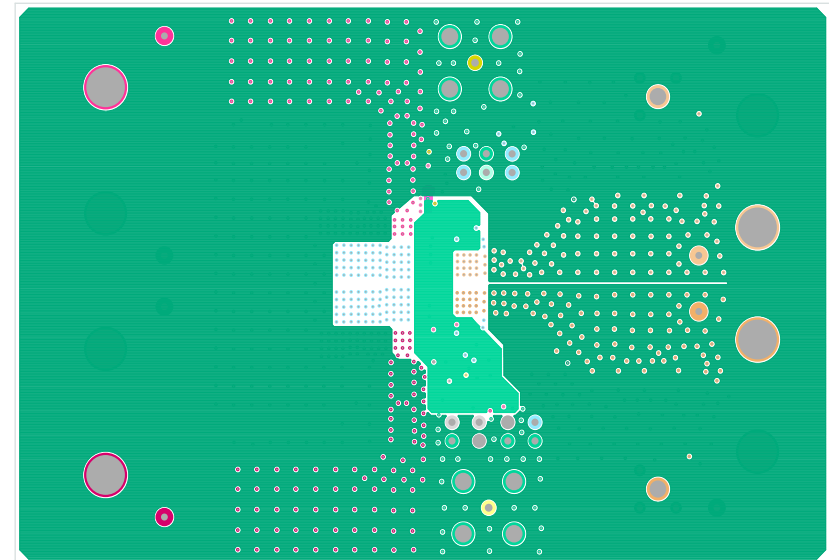

FIGURE 6. LAYER 3

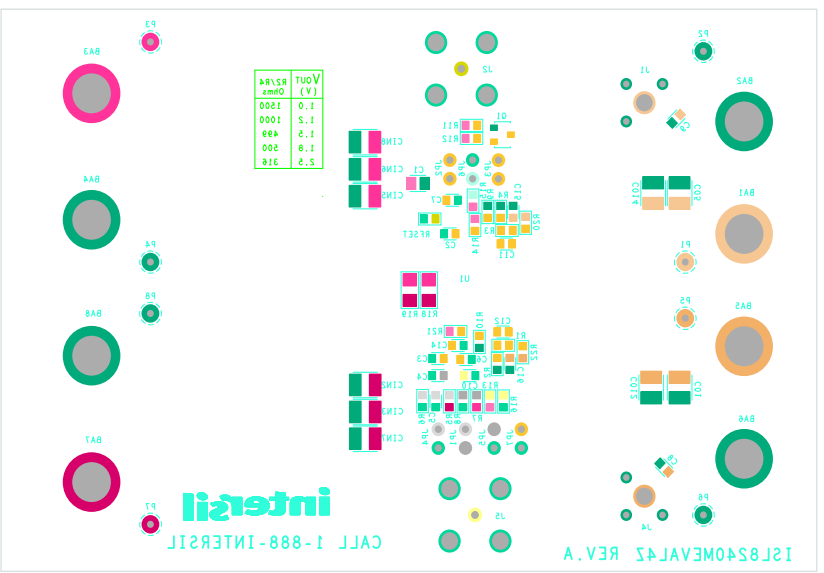

FIGURE 8. BOTTOM SILKSCREEN

Layout (Continued)

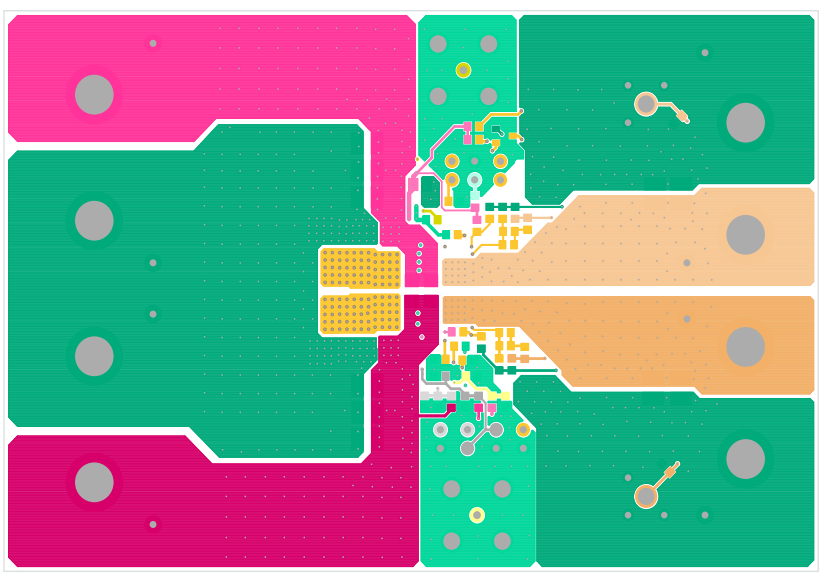

FIGURE 7. BOTTOM LAYER SOLDER SIDE

Bill of Materials

PART NUMBER	REF DES	QTY	VALUE	TOL. (%)	VOLTAGE	POWER	PACKAGE TYPE	JEDEC TYPE	MANUFACTURER	DESCRIPTION
575-4	BA1, BA2, BA3, BA4, BA5, BA6, BA7, BA8	8					CONN	CON_BAN_575		
GRM21BR71C475KA73L	C1	1	4.7µF	10	16V		805	CAP_0805	Murata	Ceramic Capacitor
H1045-OPEN	C2, C3, C6, C7	4	OPEN		OPEN		603	CAP_0603	Generic	Multilayer Capacitor
H1045-00102-50V10	C4, C5, C8, C9	4	1000pF	10	50V		603	CAP_0603	Generic	Multilayer Capacitor
H1045-OPEN	C10, C11, C12, C13, C14, C17	6	OPEN		OPEN		603	CAP_0603	Generic	Multilayer Capacitor
H1045-00102-16V10	C15, C16	2	1000pF	10	16V		603	CAP_0603	Generic	Multilayer Capacitor
H1082-00107-6R3V20-T	C01, C03, C05, C07, C011, C012, C013, C014	8	100µF	20	6.3V		1210	CAP_1210	TDK	Ceramic Chip Capacitor
H1082-OPEN	C02, C06, C09, C10	4	OPEN		OPEN		1210	CAP_1210	Generic	Ceramic Chip Capacitor
6TPF330M9L	C04, C08	2	330µF	20	6.3V		SMD	CAP_7343_149	Sanyo	Tantalum Polymer Capacitor
EEVHA1E331UP	CIN1, CIN4	2	330µF	20	25V		SMD	CAPAE_315X402	Panasonic	
TMK325B7226MM-TR	CIN2, CIN3, CIN5, CIN6, CIN7, CIN8	6	22µF	20	25V		1210	CAP_1210	Taiyo Yuden	Ceramic Chip Capacitor
131-4353-00	J1, J4	2					CONN	TEK131-4353-00		
31-5329-52RFX	J2, J5	2					CONN	CON_BNC_31_5329_52RFX		
JUMPER2_100	JP1-JP7	7					THOLE	JUMPER-1		
SSL-LXA3025IGC	LED1	1					SMD	LED_3X2_5MM		
5002	P1, P2, P3, P4, P5, P6, P7, P8	8					THOLE	MTP500X		
2N7002-7-F	Q1	1					SOT23	SOT23		
H2511-01001-1/10W1	R1, R3	2	1kΩ	1		1/10W	603	RES_0603		Chip Resistor
H2511-01501-1/10W1	R2	1	1.5kΩ	1		1/10W	603	RES_0603		Chip Resistor
H2511-06650-1/10W1	R4	1	665Ω	1		1/10W	603	RES_0603		Chip Resistor
H2511-06650-1/10W1	R5, R7	2	16.5Ω	1		1/10W	603	RES_0603		Chip Resistor
H2511-06650-1/10W1	R6, R8	2	4.12kΩ	1		1/10W	603	RES_0603		Chip Resistor
H2511-06650-1/10W1	R9, R10, R13, R20, R22	5	0Ω	1		1/10W	603	RES_0603		Chip Resistor
H2511-06650-1/10W1	R11, R12	2	3.32kΩ	1		1/10W	603	RES_0603		Chip Resistor
H2505-DNP-DNP-1	R14, R15, R16, R21	4	OPEN				603	RES_0603		Chip Resistor
H2513-00R00-1/4W	R18, R19	2	0Ω	1		1/4W	1206	RES_1206		Chip Resistor
H2511-02373-1/10W1	RFSET	1	237kΩ	1		1/10W	603	RES_0603		Chip Resistor
ISL8240MIRZ	U1	1					QFN			

ISL8240MEVAL4Z Performance

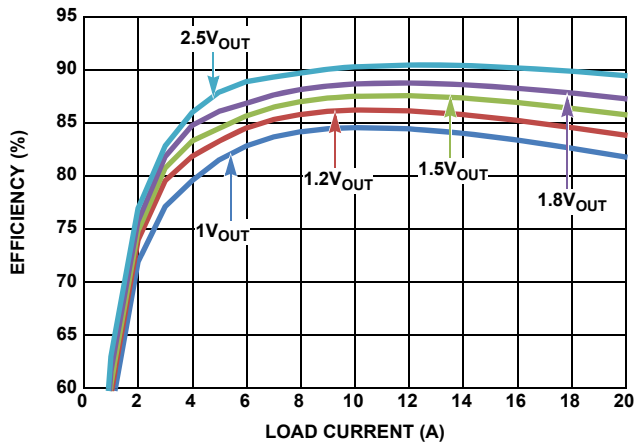

FIGURE 9. EFFICIENCY VS LOAD CURRENT (12V_{IN})

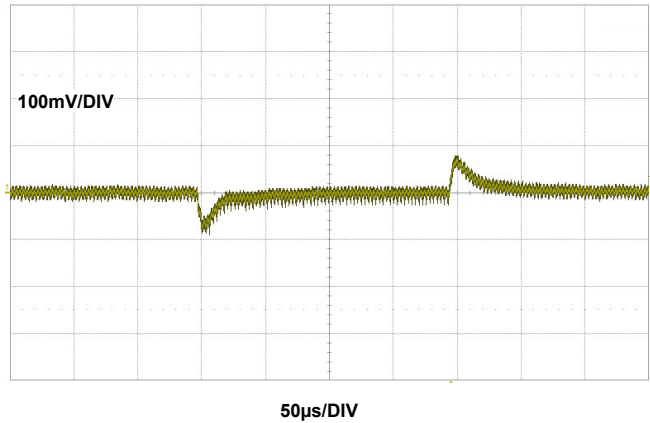

FIGURE 10. 1V_{OUT} TRANSIENT RESPONSE, I_{OUT} = 0A TO 10A, F_{SW} = 350KHZ LOAD CURRENT SLEW RATE 10A/MS

Intersil Corporation reserves the right to make changes in circuit design, software and/or specifications at any time without notice. Accordingly, the reader is cautioned to verify that the document is current before proceeding.

For information regarding Intersil Corporation and its products, see www.intersil.com