

REF3012, REF3020, REF3025, REF3030, REF3033, REF3040

High Precision, Low Drift, CMOS Voltage Reference

The REF30xx family of voltage references provides accurate voltage regulation with a maximum temperature drift of 50 ppm/°C.

The REF30xx can source or sink up to 10 mA of load current. It is supplied in a space-saving SOT-23 package, and for most applications can forgo the use of an output bypass capacitor.

Features

- Reference Voltages:
1.25 V, 2.048 V, 2.5 V, 3.0 V, 3.3 V, 4.096 V
- High Accuracy: $\pm 0.2\%$
- Low Quiescent Current: 30 μA max
- High Output Current: 10 mA Sourced or Sunk
- Maximum 50 ppm/°C Temperature Drift over the Specified Range of -40°C to $+85^\circ\text{C}$
- SOT-23 3-Lead Package
- This Device is Pb-Free, Halogen Free/BFR Free, and RoHS Compliant

Typical Applications

- Battery Powered Systems
- A/D and D/A Converters
- Precision Regulator Systems
- Power Supplies
- Portable Medical Equipment

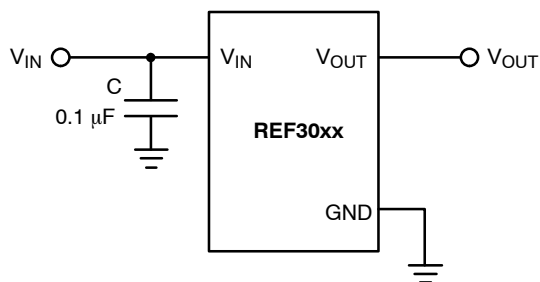
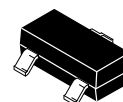

Figure 1. Application Circuit



ON Semiconductor®

<http://onsemi.com>



SOT23-3
TB SUFFIX
CASE 527AG

MARKING DIAGRAM

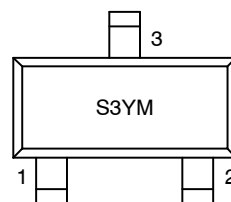

S3 = Specific Device Code
Y = Production Year
(Last Digit)
M = Production Month
(1 - 9, O, N, D)

PIN CONNECTIONS

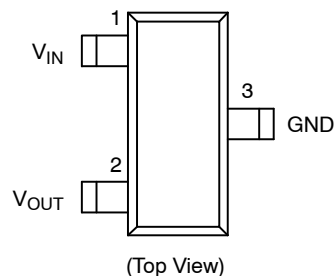

PIN FUNCTIONS

Pin No.	Pin Name	Function
1	V _{IN}	Supply Voltage Input
2	V _{OUT}	Output Voltage
3	GND	Ground

ORDERING INFORMATION

See detailed ordering and shipping information in the package dimensions section on page 2 of this data sheet.

Table 1. ORDERING INFORMATION

Device	Output Voltage	Marking	Package	Shipping †
REF3012TB-GT3	1.25 V	S3YM	SOT-23	3000 / Tape & Reel
REF3020TB-GT3	2.048 V			
REF3025TB-GT3	2.5 V			
REF3030TB-GT3	3.0 V			
REF3033TB-GT3	3.3 V			
REF3040TB-GT3 (Note 1)	4.096 V			

1. Contact factory for availability of these and other custom voltages.

†For information on tape and reel specifications, including part orientation and tape sizes, please refer to our Tape and Reel Packaging Specifications Brochure, BRD8011/D.

Table 2. ABSOLUTE MAXIMUM RATINGS (Note 2)

Rating	Value	Unit
V_{IN}	6.5	V
Storage Temperature Range	-55 to +125	°C
Junction Temperature Range	+150	°C

Stresses exceeding Maximum Ratings may damage the device. Maximum Ratings are stress ratings only. Functional operation above the Recommended Operating Conditions is not implied. Extended exposure to stresses above the Recommended Operating Conditions may affect device reliability.

2. Maximum terminal current is bounded by the maximum current handling of the switches, maximum power dissipation of the package.

Table 3. RECOMMENDED OPERATING CONDITIONS

Rating	Value	Unit
Temperature Range	-40 to +85	°C

REF3012, REF3020, REF3025, REF3030, REF3033, REF3040

Table 4. ELECTRICAL CHARACTERISTICS

($V_{IN} = 3.0\text{ V}$, $I_{OUT} = 0\text{ mA}$, $C_{OUT} = 0.001\text{ }\mu\text{F}$, -40°C to $+85^{\circ}\text{C}$ unless specified otherwise.)

Parameter	Test Conditions	Symbol	Min	Typ	Max	Unit
Output Voltage	REF3012 REF3020 REF3025 REF3030 ($V_{IN} = 5.0\text{ V}$) REF3033 ($V_{IN} = 5.0\text{ V}$) REF3040 ($V_{IN} = 5.0\text{ V}$)	V_{out}	1.2475 2.044 2.495 2.994 3.294 4.088	1.250 2.048 2.500 3.000 3.300 4.096	1.2525 2.052 2.505 3.006 3.306 4.104	V
Output Voltage Accuracy			-0.2		+0.2	%
Output Voltage Noise (Note 3)	$f = 0.1\text{ Hz to }10\text{ Hz}$			50		$\mu\text{Vp-p}$
Line Regulation	$2.7\text{ V} \leq V_{IN} \leq 5.5\text{ V}$			30	100	$\mu\text{V/V}$
Output voltage temp Drift	$-40^{\circ}\text{C} \leq T_A \leq +85^{\circ}\text{C}$	dV_{OUT}/dT		20	50	$\text{ppm}/^{\circ}\text{C}$
Long-Term Stability (Note 3)	0–1000 h			50		ppm
Load Regulation	$V_{IN} = 3\text{ V}$ $0\text{ mA} < I_{LOAD} < 10\text{ mA}$ $-10\text{ mA} < I_{LOAD} < 0\text{ mA}$	dV_{OUT}/dI_{LOAD}		100 150	250 350	$\mu\text{V}/\text{mA}$
Thermal Hysteresis (Note 3)	$\Delta T_A = 125^{\circ}\text{C}$	dT		100		ppm
Dropout Voltage	$V_{OUT} = 2.5\text{ V}$	$V_{IN} - V_{OUT}$		1	2.5	mV
Short-Circuit Current (Note 3)	$T_A = 25^{\circ}\text{C}$ OUT pin shorted to GND OUT pin shorted to IN	I_{SC}		50 20	60 40	mA
Turn On Settling Time	To 0.1% at $V_{IN} = 5\text{ V}$ with $C_L = 0$			2		ms
Power Supply Voltage	$I_L = 0$	V_S	2.7		5.5	V
Supply Current	$I_L = 0$	I_Q			30	μA
Temperature Range Specified Range Operating Range Storage Range			-40 -40 -55		+85 +85 +125	$^{\circ}\text{C}$

3. Guaranteed by design.

TYPICAL CHARACTERISTICS

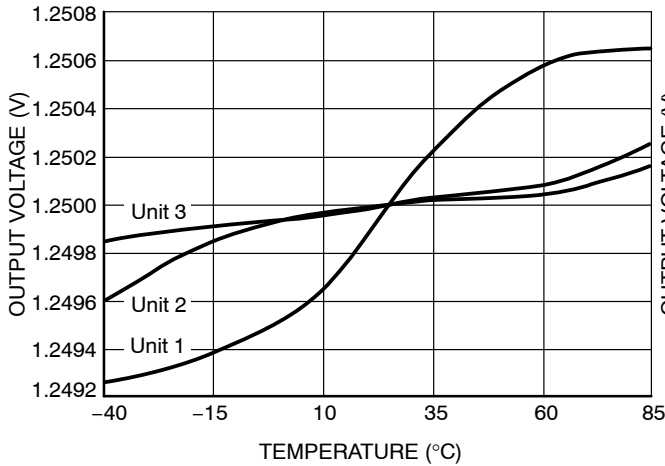

Figure 2. Output Voltage vs. Temperature

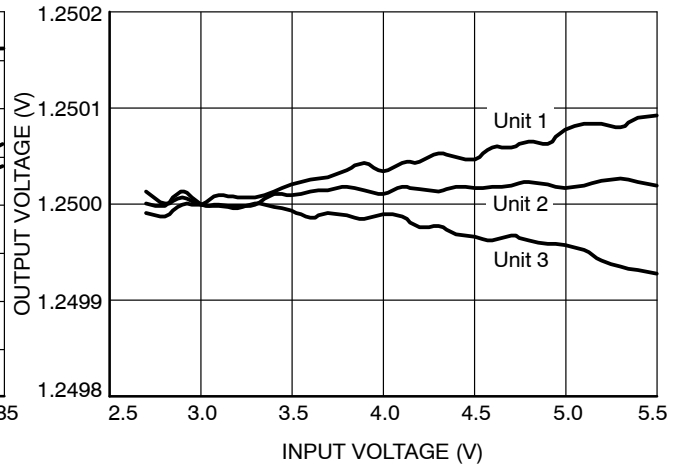

Figure 3. Output Voltage vs. Supply Voltage (No Load)

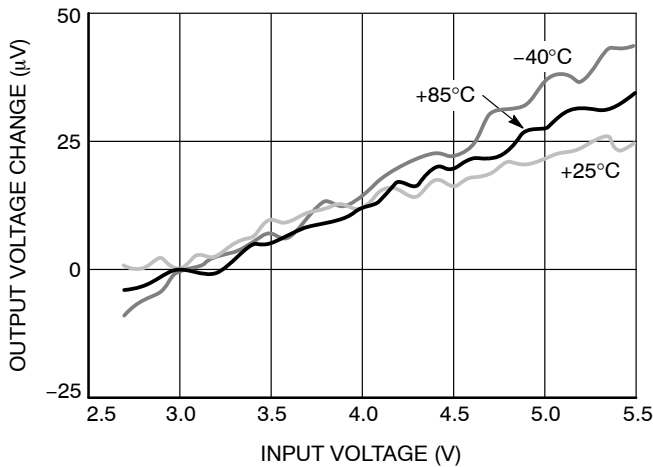

Figure 4. Line Regulation over Temperature

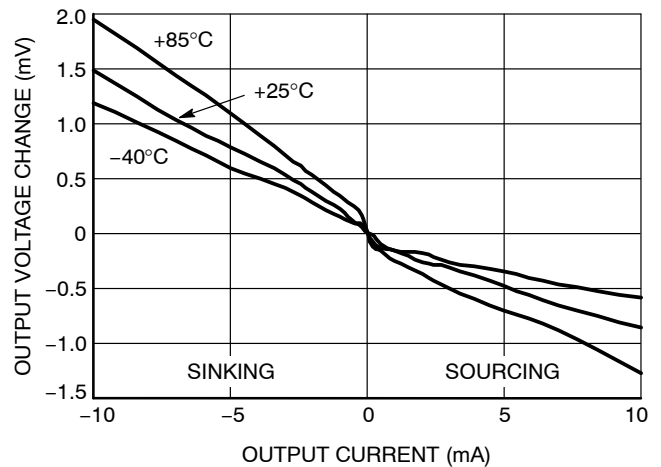

Figure 5. Load Regulation over Temperature

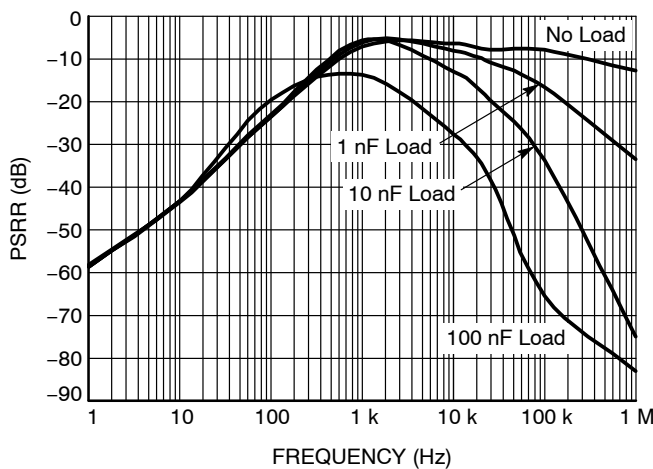

Figure 6. Power-Supply Rejection Ratio vs. Frequency

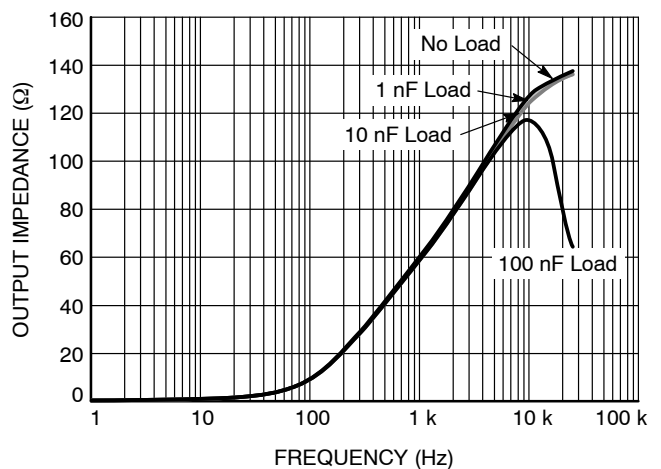

Figure 7. Output Impedance vs. Frequency

TYPICAL CHARACTERISTICS

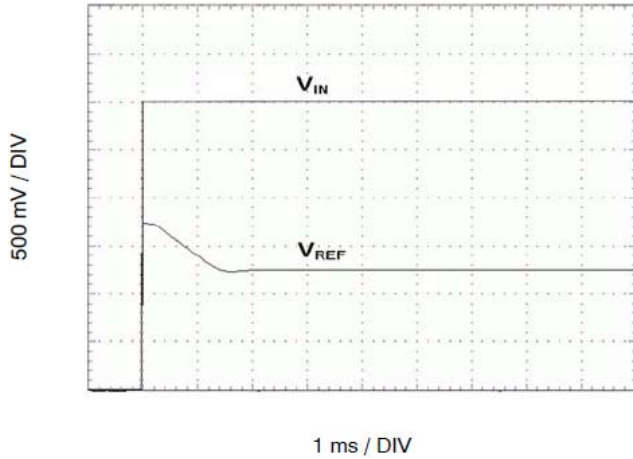

Figure 8. Step Response, $C_L = 0$, 3 V Startup

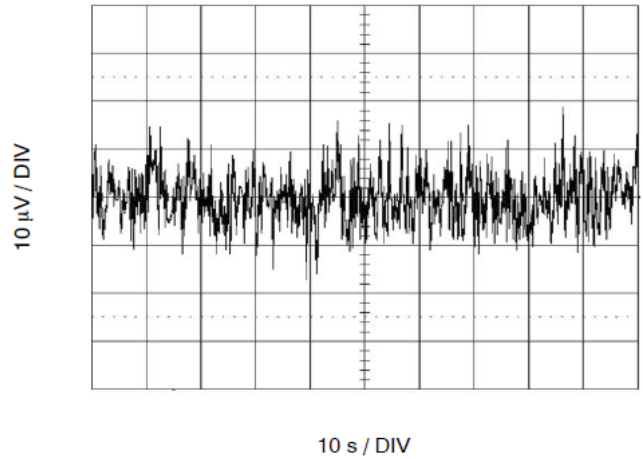

Figure 9. 0.1 Hz to 10 Hz Noise

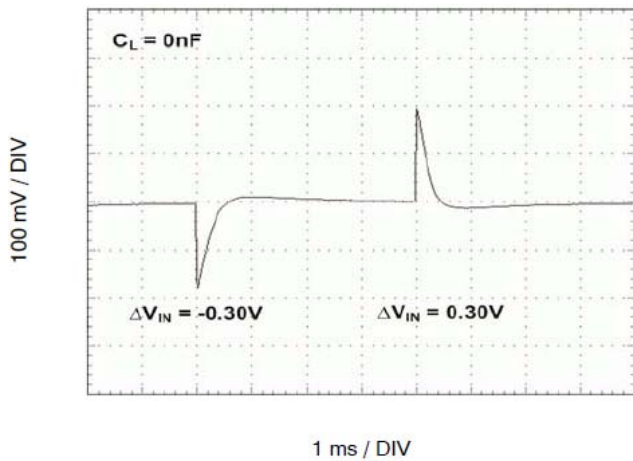

Figure 10. Line Transient Response

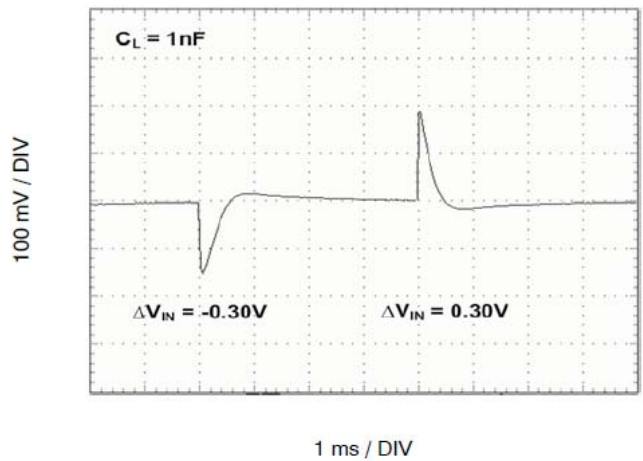

Figure 11. Line Transient Response with Cap. Load

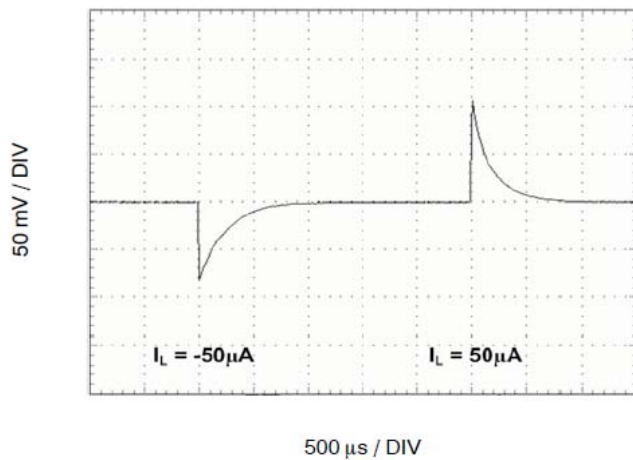

Figure 12. Load Transient ($I_L = 50 \mu A$)

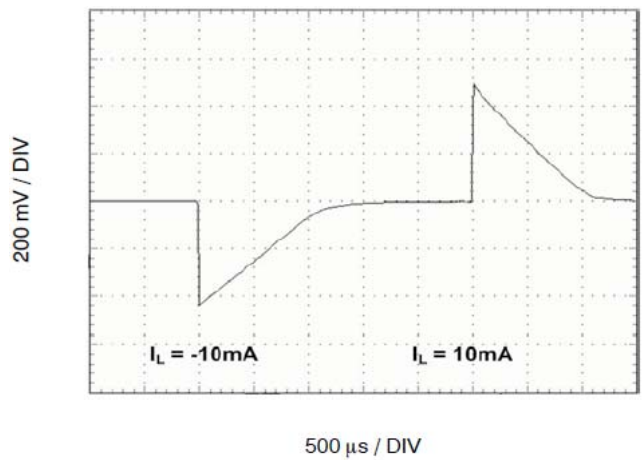

Figure 13. Load Transient ($I_L = 10 mA$)

APPLICATION INFORMATION

Application Information

A supply bypass capacitor of 0.1 μF is recommended.

In most applications, the REF30xx does not require an output bypass capacitor. For the effects of a capacitive load on device performance, see Figures 8 and 9 in the Typical Characteristics section.

Power Supply

The REF30xx family of references works at supply voltages between 2.7 V and 5.5 V. The maximum dropout voltage in this range is 2.5 mV.

While the power supply voltage rises to the specified level during power-up, the REF30xx will temporarily draw a higher than typical current. It is recommended to use a power supply with a fast rising edge.

Line Regulation

Line regulation is defined as the change in output voltage due to the change in the input voltage. For REF30xx, this change is less than 100 $\mu\text{V/V}$ across the specified supply voltage range.

Thermal Hysteresis

Thermal hysteresis is defined as the change in the output voltage after the device is cycled through the operating temperature range. This change is reported as a fraction of the nominal output voltage, in ppm. The initial output V_{PRE} is measured at 25°C. After the device is cooled to -40°C, heated to +80°C, then cooled back to 25°C, the final output voltage V_{POST} is measured. The thermal hysteresis is equal to

$$T_{\text{hHYST}} = \frac{|V_{\text{PRE}} - V_{\text{POST}}|}{V_{\text{NOM}}} \cdot 10^6 (\text{ppm}) \quad (\text{eq. 1})$$

where V_{NOM} is the nominal output voltage.

Temperature Drift

Temperature drift is defined as the change in the output voltage caused by a change in operating temperature. (See Figure 2 in the Typical Characteristics section.) The REF30xx family is designed to exhibit a temperature drift of less than 50 ppm/°C across its entire operating temperature range of -40°C to +85°C.

Noise Performance

The noise generated by the REF30xx family is typically less than 50 $\mu\text{Vp-p}$ between frequencies of 0.1 Hz to 10 Hz, as shown in the Typical Characteristic Curves. Output noise can be additionally reduced using a low-pass filter, although care should be taken, as capacitive loads affect the PSRR and the output impedance. (See the Typical Characteristics section.)

Load Regulation

Load regulation is defined as the change in output voltage due to a specified change in load current. The REF30xx family can sink or source up to 10 mA of current, with an output change of less than 250 $\mu\text{V/mA}$ when sourcing, or 350 $\mu\text{V/mA}$ when sinking current.

REF3012, REF3020, REF3025, REF3030, REF3033, REF3040

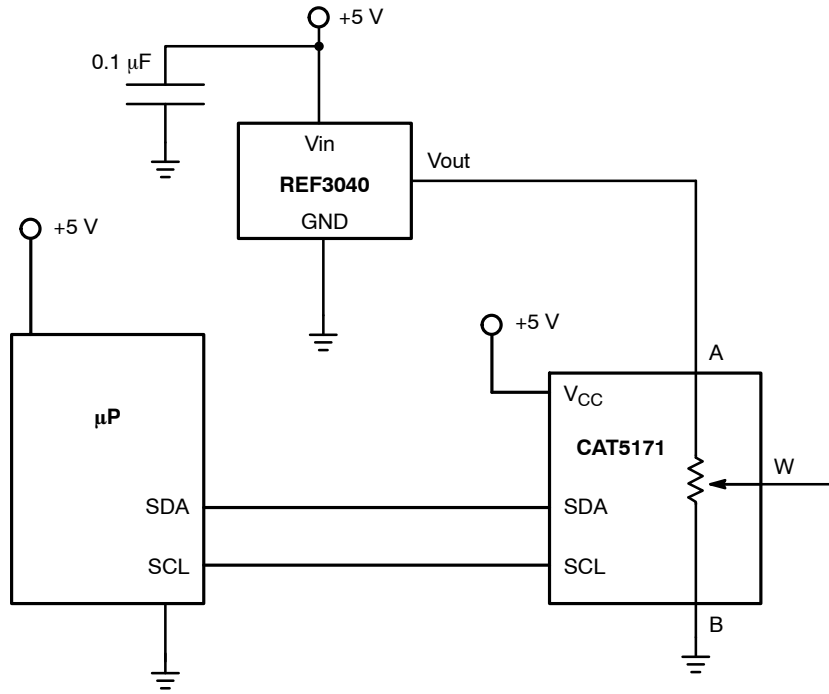

Figure 14. Adjustable Voltage Reference

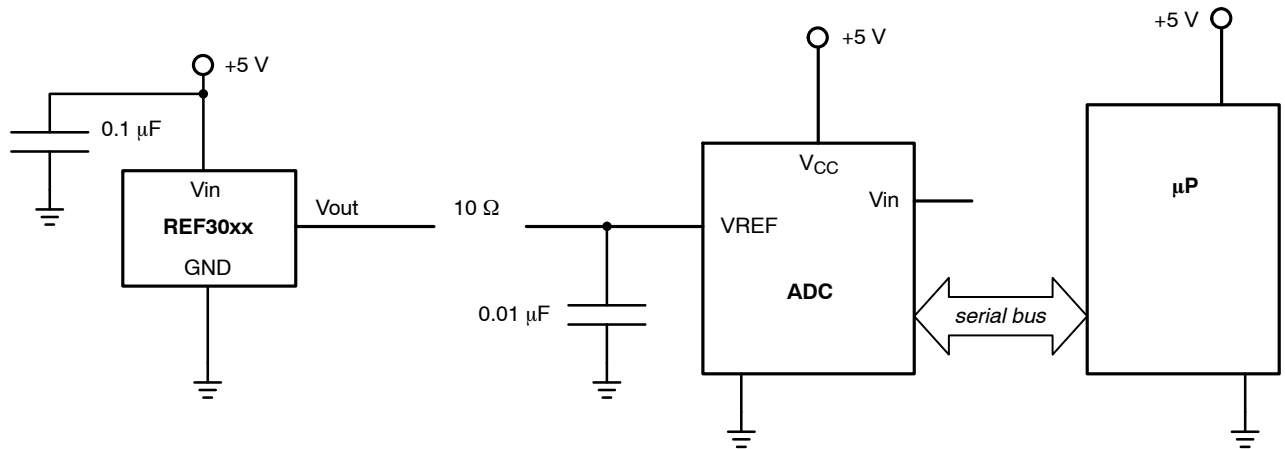
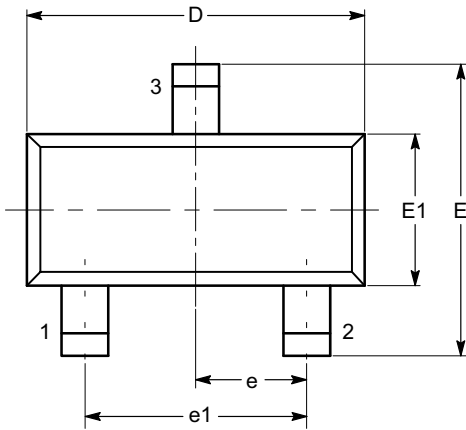

Figure 15. Data Acquisition System using REF30xx Voltage Reference, with Noise Filter

PACKAGE DIMENSIONS

SOT-23, 3 Lead
CASE 527AG-01
ISSUE O



TOP VIEW

SYMBOL	MIN	NOM	MAX
A	0.89		1.12
A1	0.013		0.10
b	0.37		0.50
c	0.085		0.18
D	2.80		3.04
E	2.10		2.64
E1	1.20		1.40
e	0.95 BSC		
e1	1.90 BSC		
L	0.40 REF		
L1	0.54 REF		
θ	0°		8°

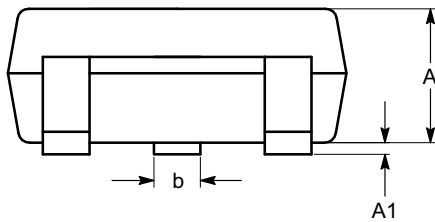

SIDE VIEW

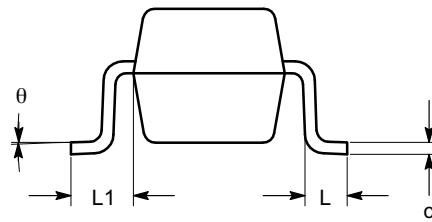

END VIEW

Notes:

- (1) All dimensions are in millimeters. Angles in degrees.
- (2) Complies with JEDEC TO-236.

ON Semiconductor and are registered trademarks of Semiconductor Components Industries, LLC (SCILLC). SCILLC reserves the right to make changes without further notice to any products herein. SCILLC makes no warranty, representation or guarantee regarding the suitability of its products for any particular purpose, nor does SCILLC assume any liability arising out of the application or use of any product or circuit, and specifically disclaims any and all liability, including without limitation special, consequential or incidental damages. "Typical" parameters which may be provided in SCILLC data sheets and/or specifications can and do vary in different applications and actual performance may vary over time. All operating parameters, including "Typicals" must be validated for each customer application by customer's technical experts. SCILLC does not convey any license under its patent rights nor the rights of others. SCILLC products are not designed, intended, or authorized for use as components in systems intended for surgical implant into the body, or other applications intended to support or sustain life, or for any other application in which the failure of the SCILLC product could create a situation where personal injury or death may occur. Should Buyer purchase or use SCILLC products for any such unintended or unauthorized application, Buyer shall indemnify and hold SCILLC and its officers, employees, subsidiaries, affiliates, and distributors harmless against all claims, costs, damages, and expenses, and reasonable attorney fees arising out of, directly or indirectly, any claim of personal injury or death associated with such unintended or unauthorized use, even if such claim alleges that SCILLC was negligent regarding the design or manufacture of the part. SCILLC is an Equal Opportunity/Affirmative Action Employer. This literature is subject to all applicable copyright laws and is not for resale in any manner.

PUBLICATION ORDERING INFORMATION

LITERATURE FULFILLMENT:
Literature Distribution Center for ON Semiconductor
P.O. Box 5163, Denver, Colorado 80217 USA
Phone: 303-675-2175 or 800-344-3860 Toll Free USA/Canada
Fax: 303-675-2176 or 800-344-3867 Toll Free USA/Canada
Email: orderlit@onsemi.com

N. American Technical Support: 800-282-9855 Toll Free
USA/Canada
Europe, Middle East and Africa Technical Support:
Phone: 421 33 790 2910
Japan Customer Focus Center
Phone: 81-3-5773-3850

ON Semiconductor Website: www.onsemi.com
Order Literature: <http://www.onsemi.com/orderlit>
For additional information, please contact your local Sales Representative