

## Class H(K) Fuseblocks Catalog Data

| Catalog Number | Covers         |               | Voltage | Current | Number of Poles | Label       |
|----------------|----------------|---------------|---------|---------|-----------------|-------------|
|                | w/o Indication | w/ Indication |         |         |                 |             |
| HM25100-1CR    | CVR-RH-25100   | CVRI-RH-25100 | 250     | 100     | 1               | HM25100-1CR |
| HM25100-2CR    |                |               |         |         | 2               | HM25100-2CR |
| HM25100-3CR    |                |               |         |         | 3               | HM25100-3CR |
| HM25200-1CR    | CVR-RH-25200   | CVRI-RH-25200 |         | 200     | 1               | HM25200-1CR |
| HM25200-2CR    |                |               |         |         | 2               | HM25200-2CR |
| HM25200-3CR    |                |               |         |         | 3               | HM25200-3CR |
| HM25400-1CR    | CVR-RH-25400   | CVRI-RH-25400 |         | 400     | 1               | HM25400-1CR |
| HM25400-2CR    |                |               |         |         | 2               | HM25400-2CR |
| HM25400-3CR    |                |               |         |         | 3               | HM25400-3CR |
| HM25600-1CR    | CVR-RH-25600   | CVRI-RH-25600 | 600     | 1       | HM25600-1CR     |             |
| HM25600-2CR    |                |               |         | 2       | HM25600-2CR     |             |
| HM25600-3CR    |                |               |         | 3       | HM25600-3CR     |             |

| Catalog Number | Covers         |               | Voltage | Current | Number of Poles | Label       |
|----------------|----------------|---------------|---------|---------|-----------------|-------------|
|                | w/o Indication | w/ Indication |         |         |                 |             |
| HM60100-1CR    | CVR-RH-60100   | CVRI-RH-60100 | 600     | 100     | 1               | HM60100-1CR |
| HM60100-2CR    |                |               |         |         | 2               | HM60100-2CR |
| HM60100-3CR    |                |               |         |         | 3               | HM60100-3CR |
| HM60200-1CR    | CVR-RH-60200   | CVRI-RH-60200 |         | 200     | 1               | HM60200-1CR |
| HM60200-2CR    |                |               |         |         | 2               | HM60200-2CR |
| HM60200-3CR    |                |               |         |         | 3               | HM60200-3CR |
| HM60400-1CR    | CVR-RH-60400   | CVRI-RH-60400 |         | 400     | 1               | HM60400-1CR |
| HM60400-2CR    |                |               |         |         | 2               | HM60400-2CR |
| HM60400-3CR    |                |               |         |         | 3               | HM60400-3CR |
| HM60600-1CR    | CVR-RH-60600   | CVRI-RH-60600 | 600     | 1       | HM60600-1CR     |             |
| HM60600-2CR    |                |               |         | 2       | HM60600-2CR     |             |
| HM60600-3CR    |                |               |         | 3       | HM60600-3CR     |             |



St. Louis MO 63178

---

TITLE:  
**Class H fuse holder-CUST**

---

SCALE: 1:1      SIZE: A3      SHEET: 1 OF 14

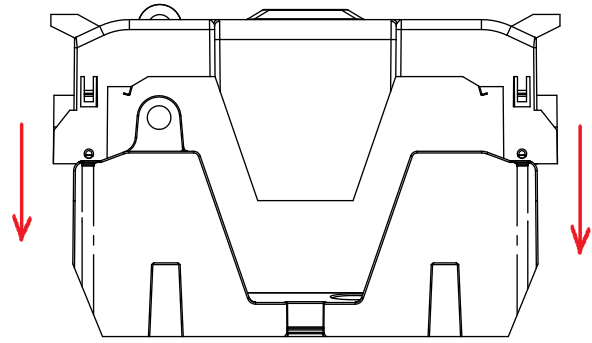

PUSH DOWN

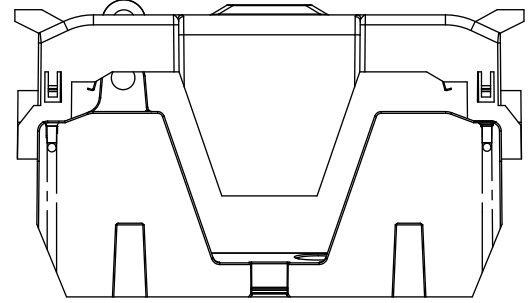
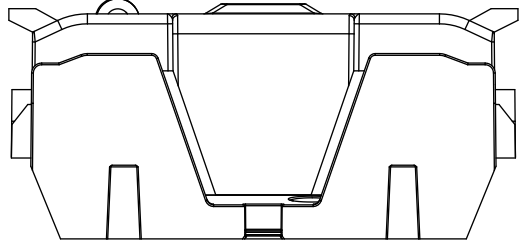

LIFT UP

LIFT UP, THEN  
ROTATE OVER

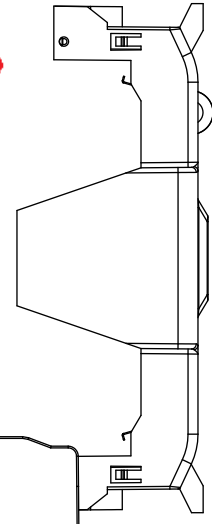
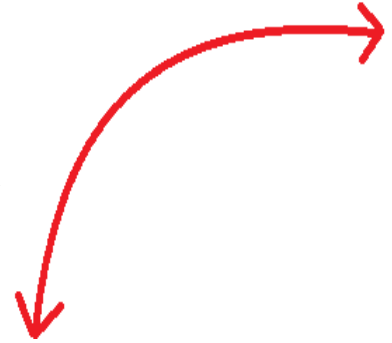

**COOPER Bussmann**  
St. Louis MO 63178

TITLE:  
**Class H fuse holder-CUST**

SCALE: 1:2      SIZE: A3      SHEET: 2 OF 14

www.Bussmann.com

**HM25100-1CR**

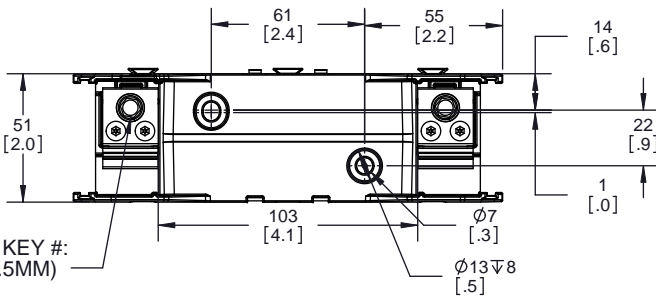

ALLEN KEY #: 3/16" (5.5MM)

**HM25100-1CR WITH CVR-RH-25100 INSTALLED**

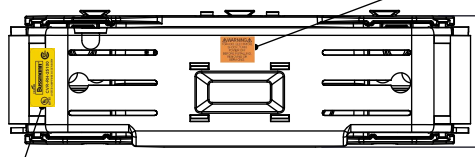

**WARNING**  
TO AVOID ELECTRICAL SHOCK, TURN POWER OFF BEFORE INSTALLING, REMOVING OR SERVICING.

**HM25100-1CR WITH CVRI-RH-25100 INSTALLED**

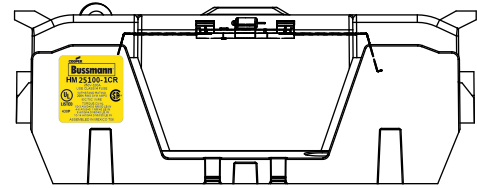
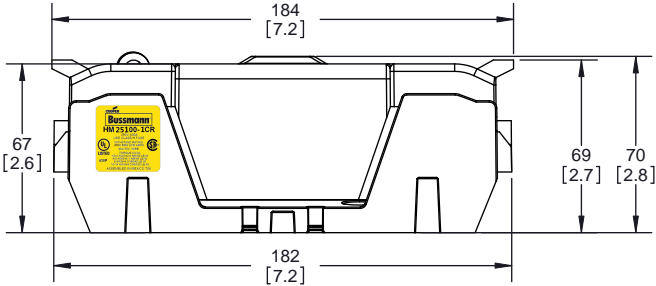
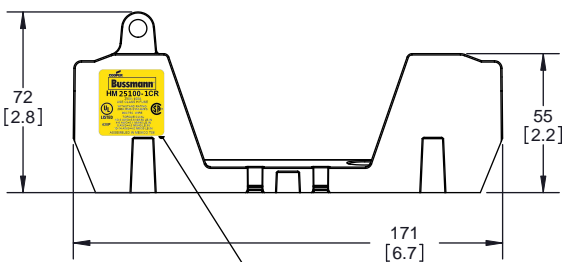
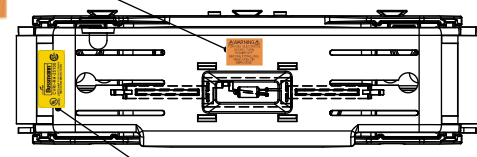

**CVR-RH-25100**

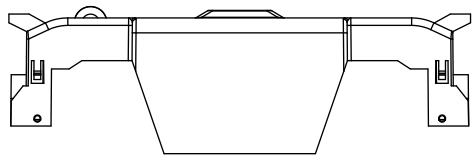

**CVRI-RH-25100**

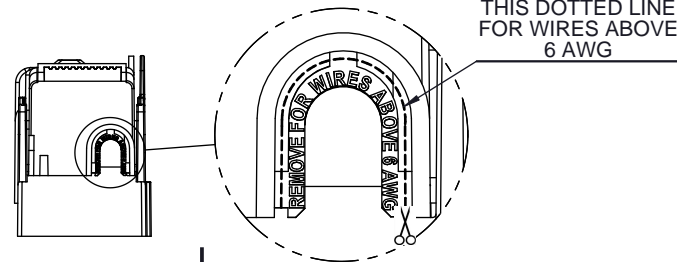
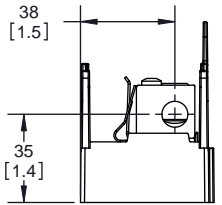
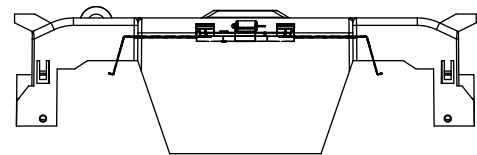

**COOPER Bussmann**  
St. Louis MO 63178

TITLE: **Class H fuse holder-CUST-250V**

SCALE: 1:1 SIZE: A3 SHEET: 3 OF 14

DESIGN UNITS: METRIC (mm)  
UNLESS OTHERWISE SPECIFIED [INCHES]

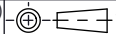

THIRD ANGLE PROJECTION

**HM25100-2CR**

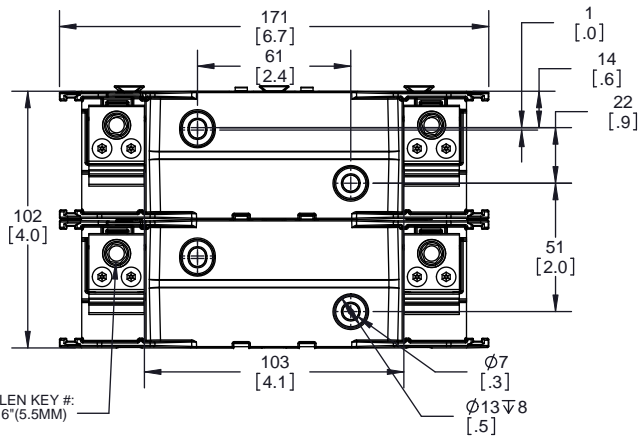

**HM25100-2CR  
WITH CVR-RH-25100 INSTALLED**

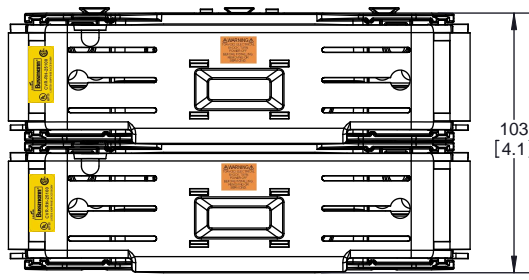

**HM25100-2CR  
WITH CVRI-RH-25100 INSTALLED**

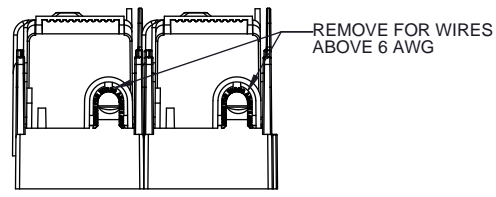
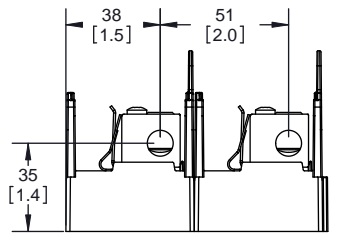
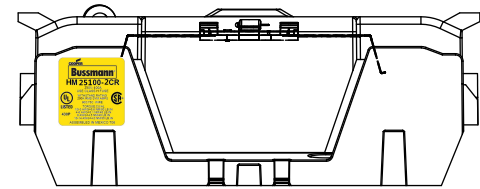
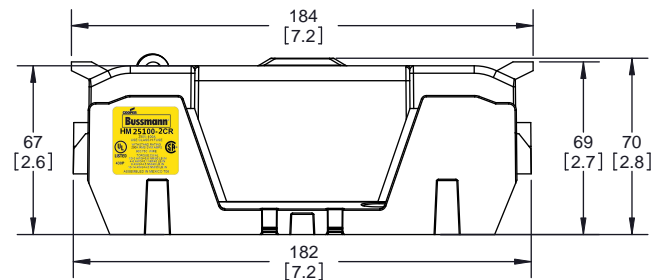
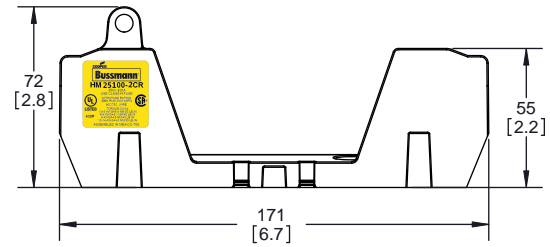
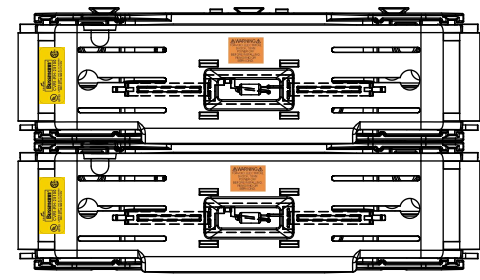

**COOPER Bussmann**  
St. Louis MO 63178

TITLE:  
**Class H fuse holder-CUST-250V**

SCALE: 1:1      SIZE: A3      SHEET: 4 OF 14



DESIGN UNITS: METRIC (mm)  
UNLESS OTHERWISE SPECIFIED  
[INCHES]

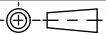

THIRD ANGLE PROJECTION

**HM25100-3CR**

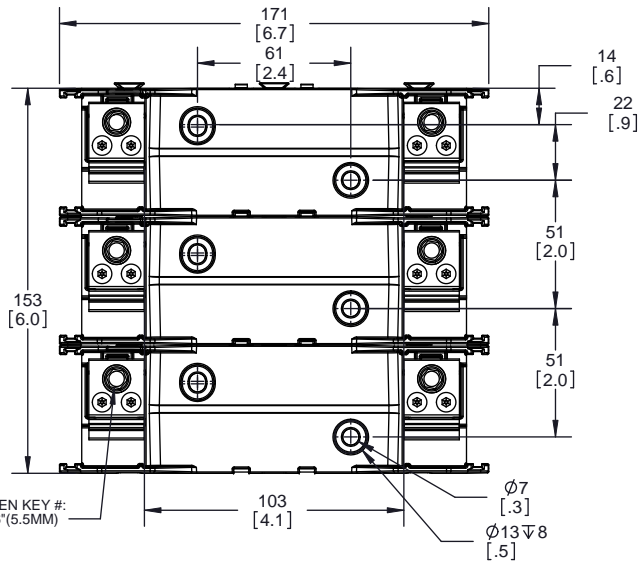

**HM25100-3CR  
WITH CVR-RH-25100 INSTALLED**

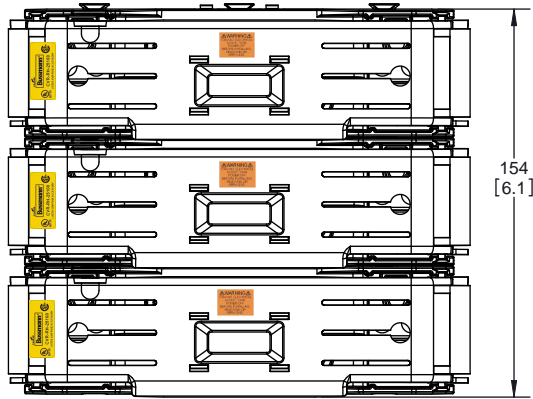

**HM25100-3CR  
WITH CVRI-RH-25100 INSTALLED**

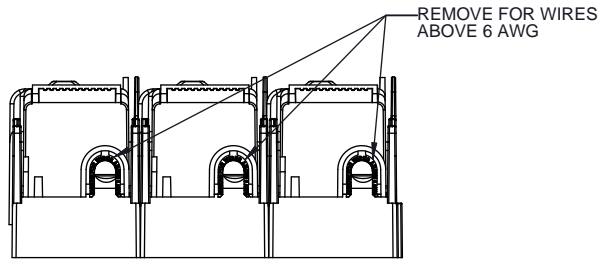
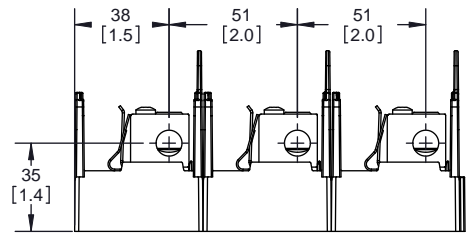
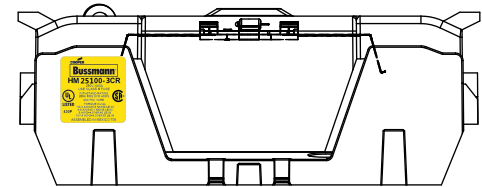
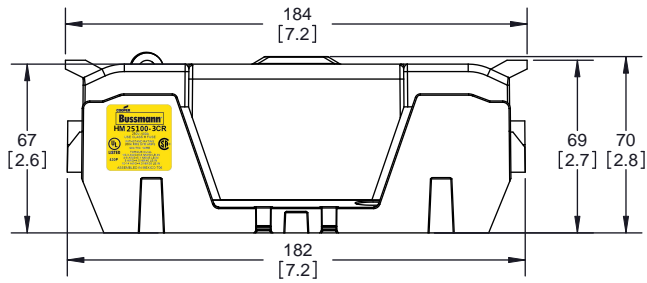
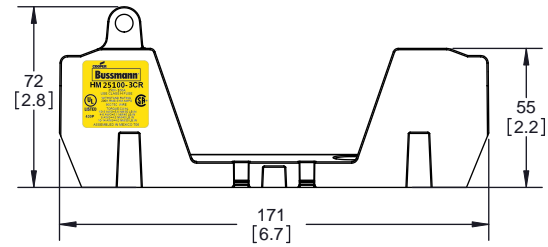
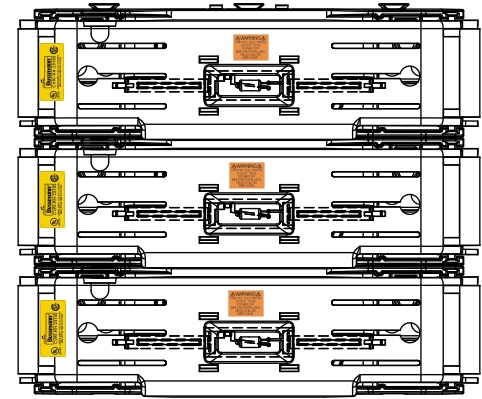

**COOPER Bussmann**  
St. Louis MO 63178

**Class H fuse holder-CUST-250V**

SCALE: 1:1      SIZE: A3      SHEET: 5 OF 14

HM25200-1CR

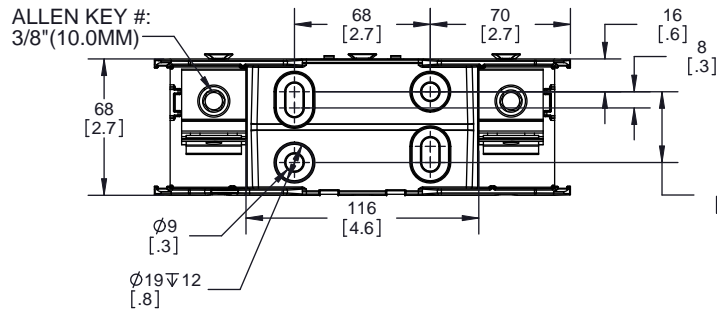

HM25200-1CR  
WITH CVR-RH-25200 INSTALLED

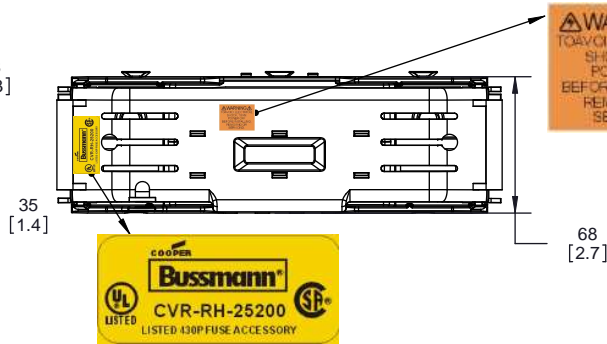

HM25200-1CR  
WITH CVRI-RH-25200 INSTALLED

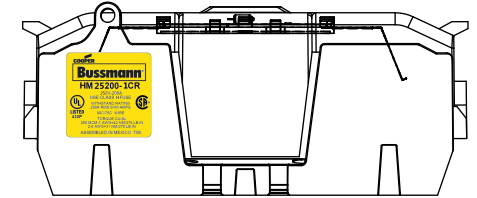
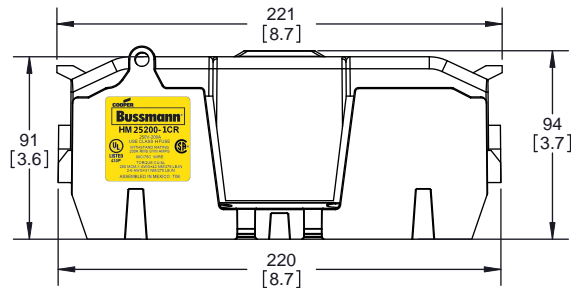
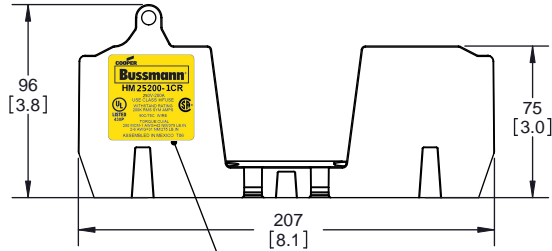
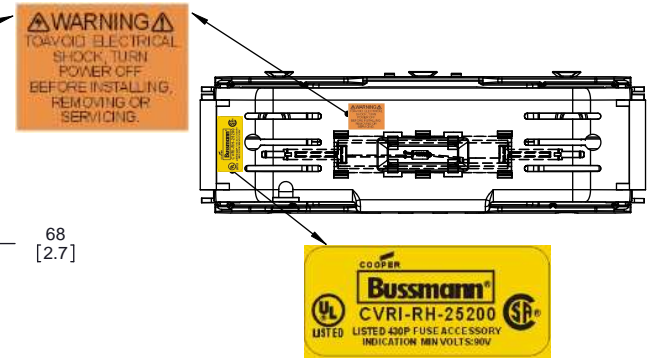

CVR-RH-25200

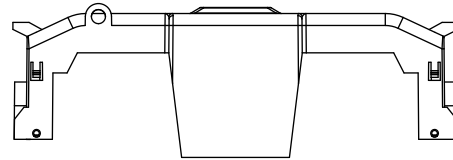

CVRI-RH-25200

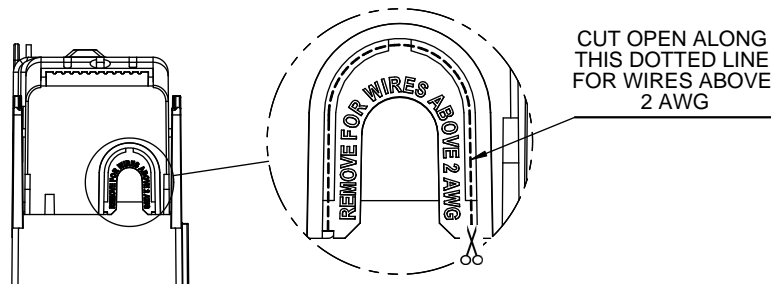
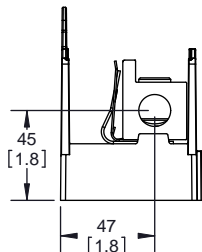
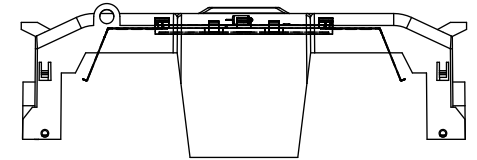

**COOPER Bussmann**  
St. Louis MO 63178

TITLE:  
**Class H fuse holder-CUST-250V**

SCALE: 1:1      SIZE: A3      SHEET: 6 OF 14

DESIGN UNITS: METRIC (mm)  
UNLESS OTHERWISE SPECIFIED [INCHES]

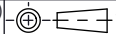

THIRD ANGLE PROJECTION

**HM25200-2CR**

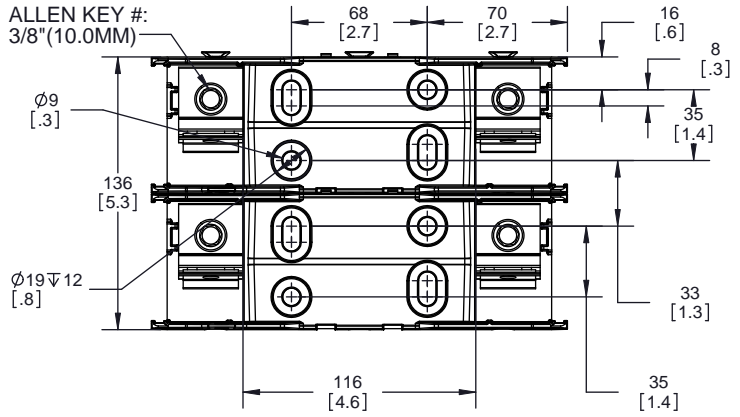

**HM25200-2CR  
WITH CVR-RH-25200 INSTALLED**

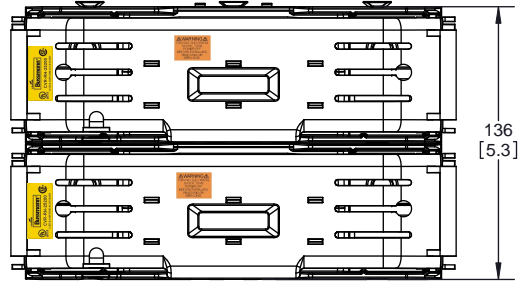

**HM25200-2CR  
WITH CVRI-RH-25200 INSTALLED**

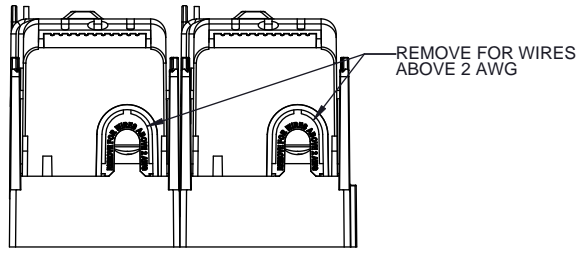
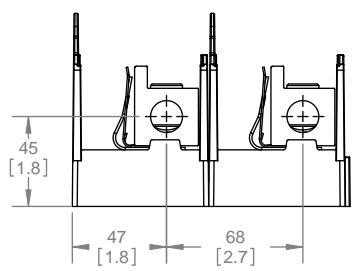
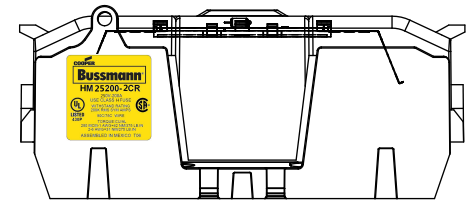
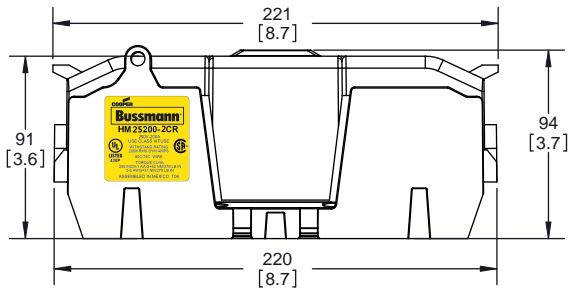
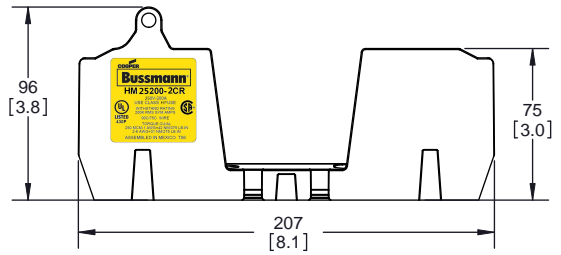

**COOPER Bussmann**  
St. Louis MO 63178

TITLE:  
**Class H fuse holder-CUST-250V**

SCALE: 1:1      SIZE: A3      SHEET: 7 OF 14

DESIGN UNITS: METRIC (mm)  
UNLESS OTHERWISE SPECIFIED  
[INCHES]

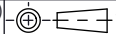

THIRD ANGLE PROJECTION

**HM25200-3CR**

**HM25200-3CR  
WITH CVR-RH-25200 INSTALLED**

**HM25200-3CR  
WITH CVRI-RH-25200 INSTALLED**

ALLEN KEY #:  
3/8" (10.0MM)

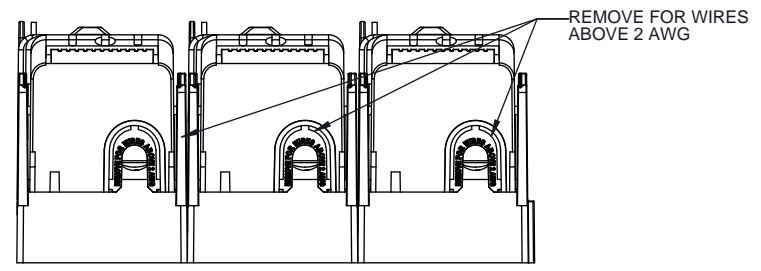
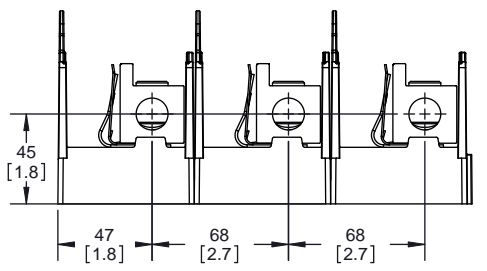
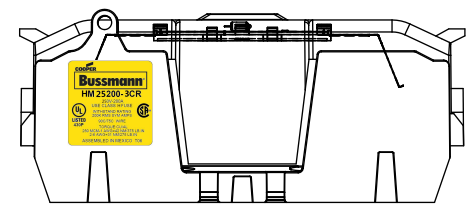
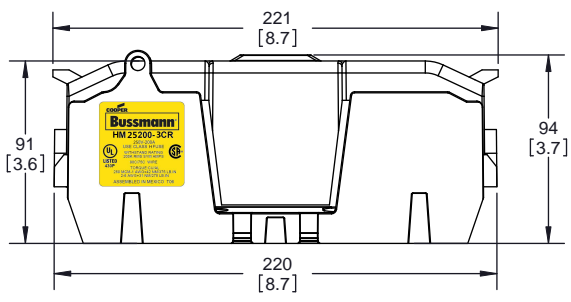
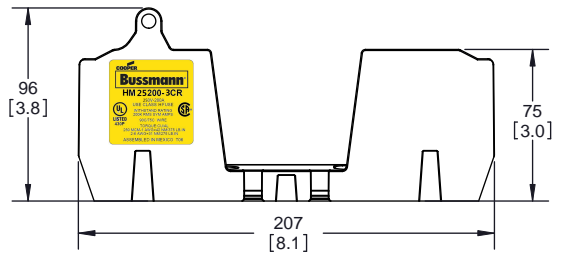
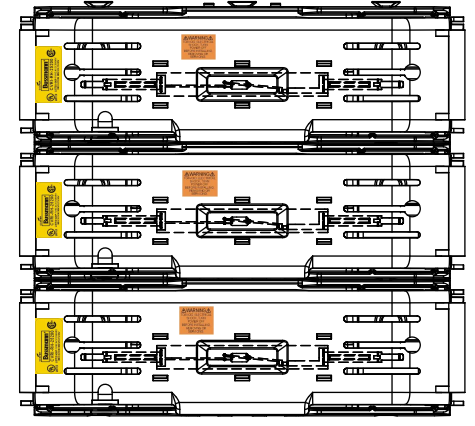
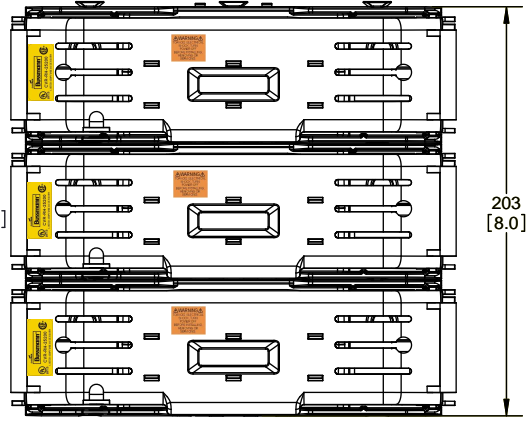
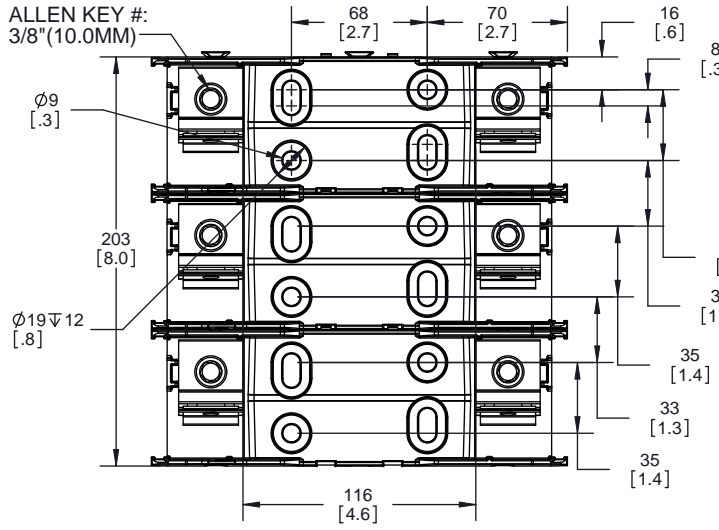

**COOPER Bussmann**  
St. Louis MO 63178

TITLE:  
**Class H fuse holder-CUST-250V**

SCALE: 1:1      SIZE: A3      SHEET: 8 OF 14

DESIGN UNITS: METRIC (mm)  
UNLESS OTHERWISE SPECIFIED  
[INCHES]

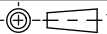

THIRD ANGLE PROJECTION

**HM25400-1CR**

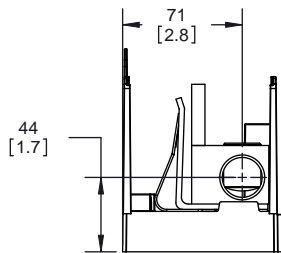
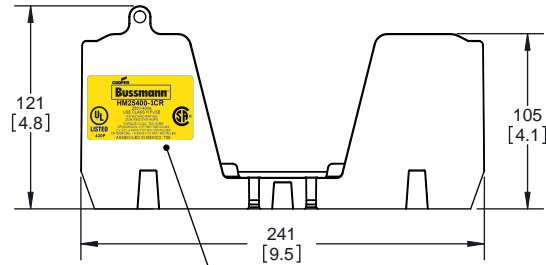
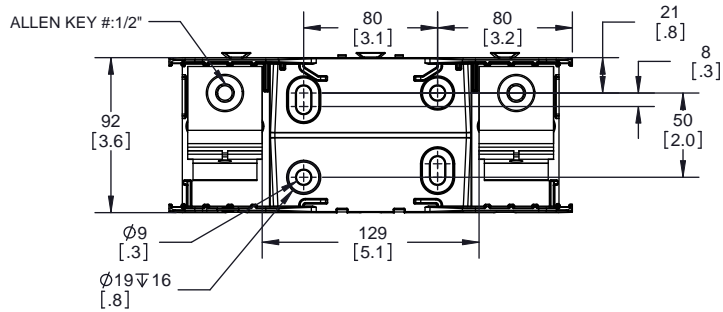

**HM25400-1CR  
WITH CVR-RH-25400 INSTALLED**

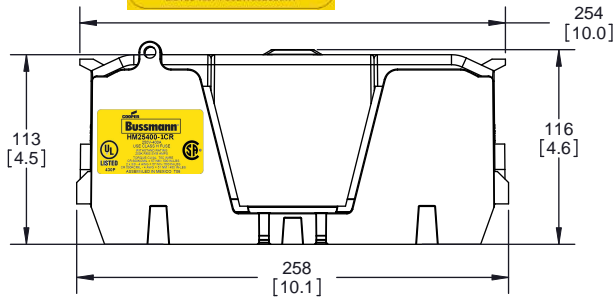
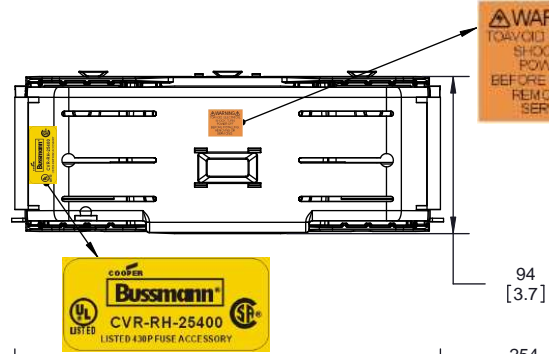

**CVR-RH-25400**

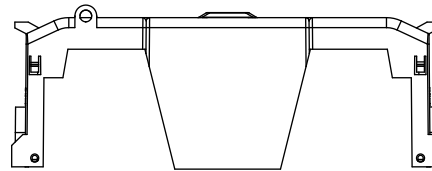

**HM25400-1CR  
WITH CVRI-RH-25400 INSTALLED**

**WARNING**  
TO AVOID ELECTRICAL SHOCK, TURN POWER OFF BEFORE INSTALLING, REMOVING OR SERVICING.

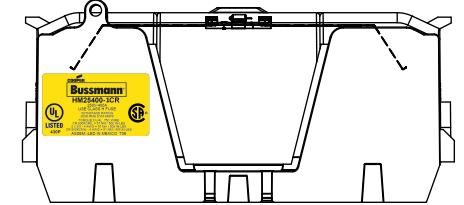
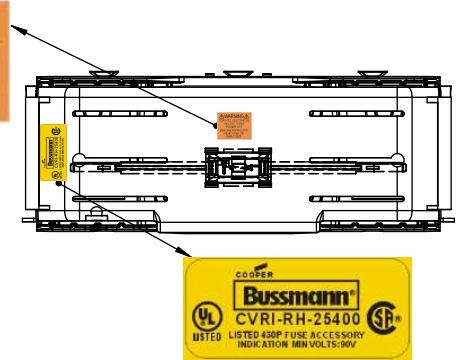

**CVRI-RH-25400**

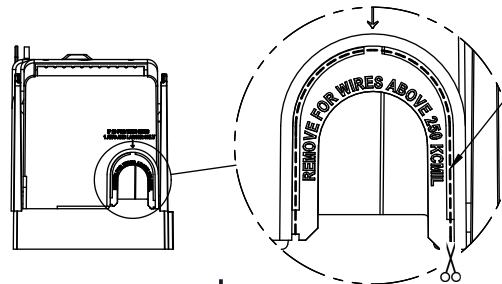
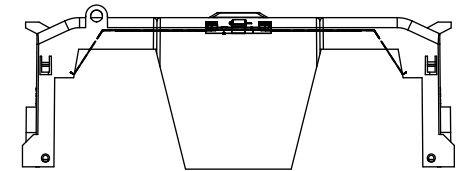

**COOPER Bussmann**  
St. Louis MO 63178

**Class H fuse holder-CUST-250V**

SCALE: 1:1 SIZE: A3 SHEET: 9 OF 14

DESIGN UNITS: METRIC (mm)  
UNLESS OTHERWISE SPECIFIED [INCHES]

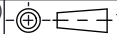

THIRD ANGLE PROJECTION

**HM25400-2CR**

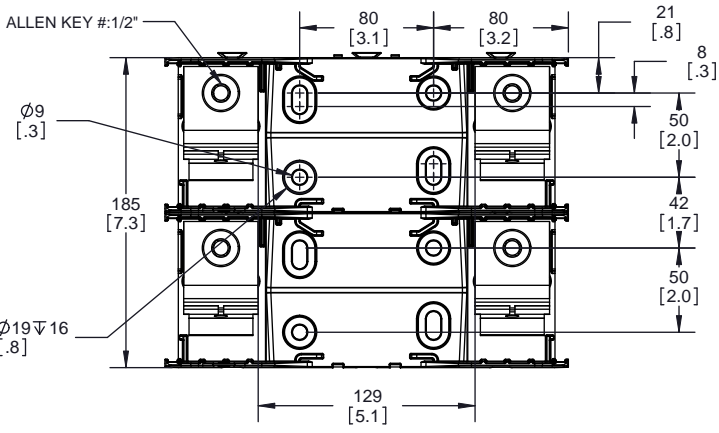

**HM25400-2CR  
WITH CVR-RH-25400 INSTALLED**

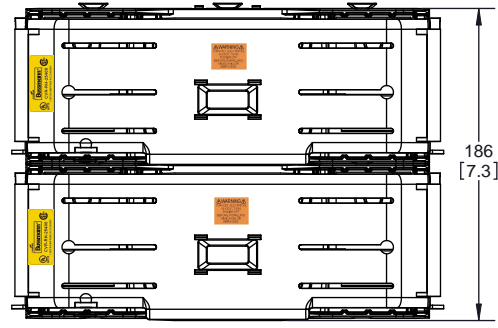

**HM25400-2CR  
WITH CVRI-RH-25400 INSTALLED**

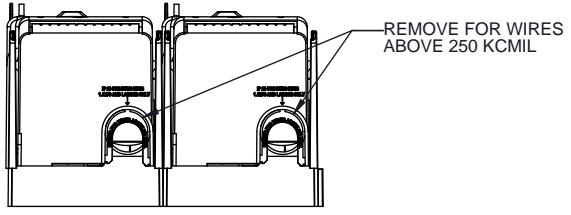
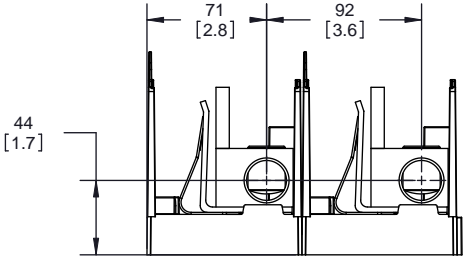
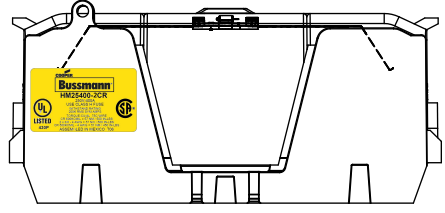
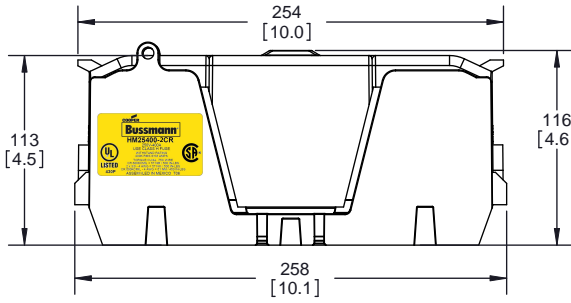
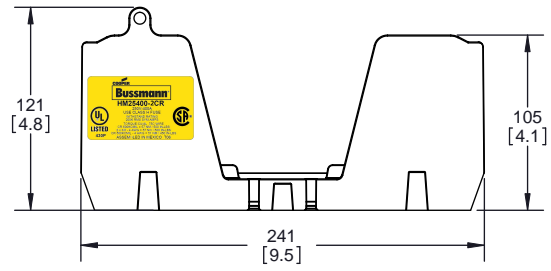
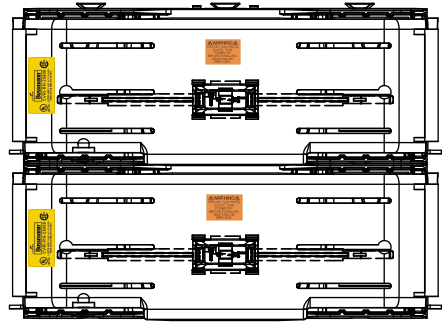

**COOPER Bussmann**  
St. Louis MO 63178

TITLE:  
**Class H fuse holder-CUST-250V**

SCALE: 1:1      SIZE: A3      SHEET: 10 OF 14

DESIGN UNITS: METRIC (mm)  
UNLESS OTHERWISE SPECIFIED [INCHES]

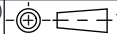

THIRD ANGLE PROJECTION

**HM25400-3CR**

**HM25400-3CR  
WITH CVR-RH-25400 INSTALLED**

**HM25400-3CR  
WITH CVRI-RH-25400 INSTALLED**

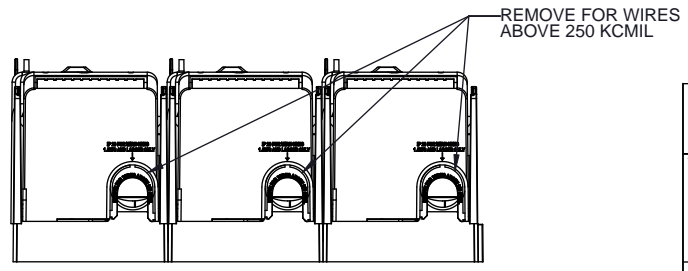
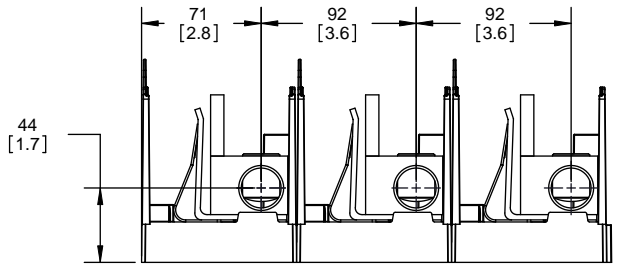
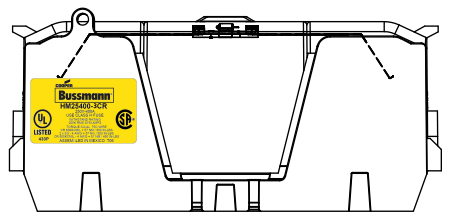
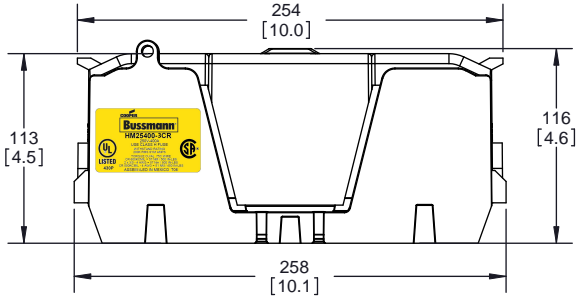
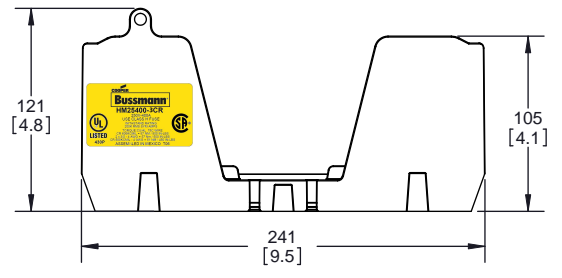
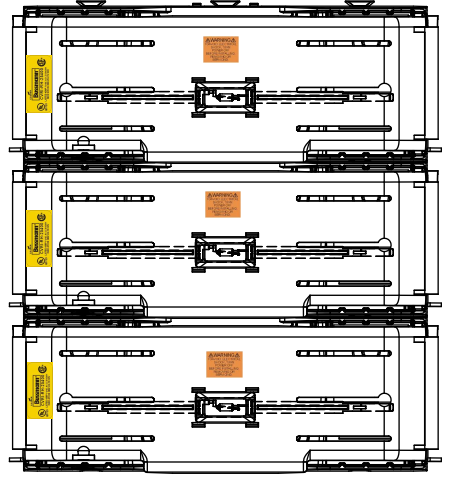
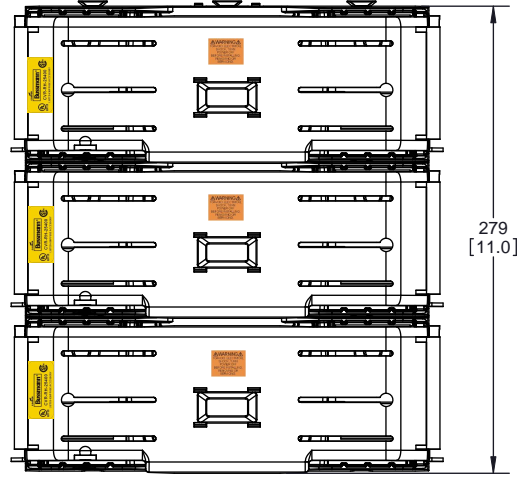
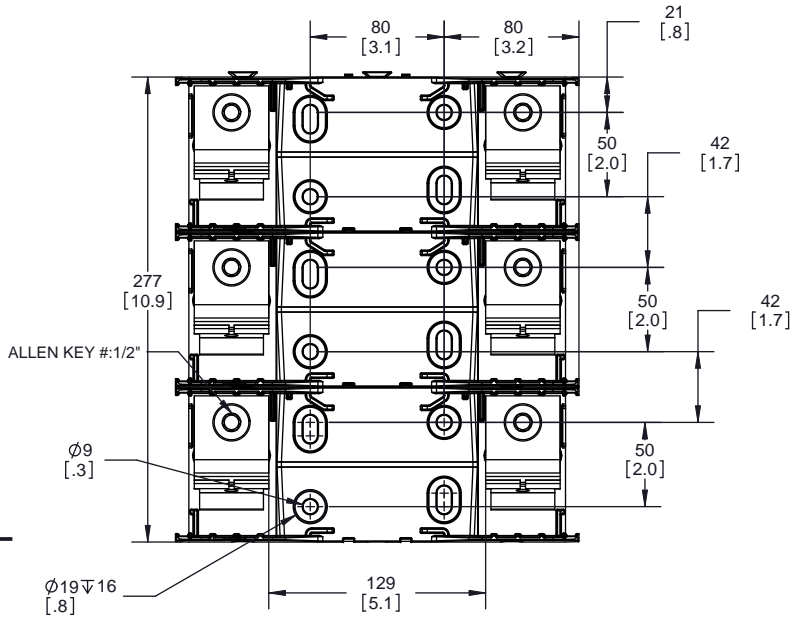

|  |             |                    |
|--|-------------|--------------------|
| <b>COOPER Bussmann</b><br>St. Louis MO 63178   |             |                    |
| TITLE:<br><b>Class H fuse holder-CUST-250V</b> |             |                    |
| SCALE:<br>1:1                                  | SIZE:<br>A3 | SHEET:<br>11 OF 14 |



DESIGN UNITS: METRIC (mm) UNLESS OTHERWISE SPECIFIED  
 THIRD ANGLE PROJECTION

**HM25600-1CR**

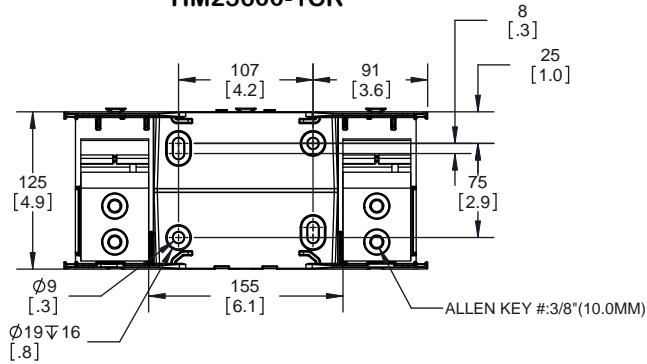

**HM25600-1CR WITH CVR-RH-25600 INSTALLED**

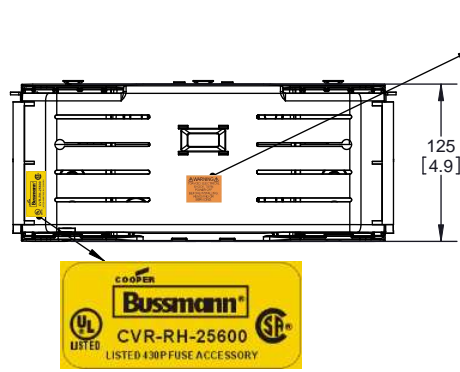

**HM25600-1CR WITH CVRI-RH-25600 INSTALLED**

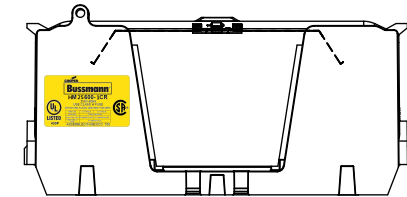
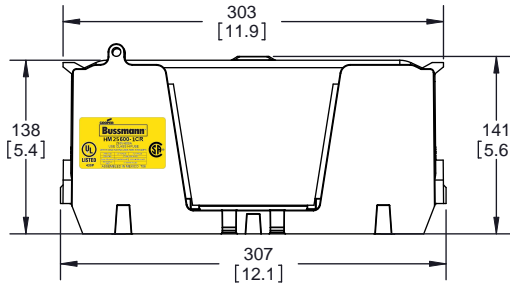
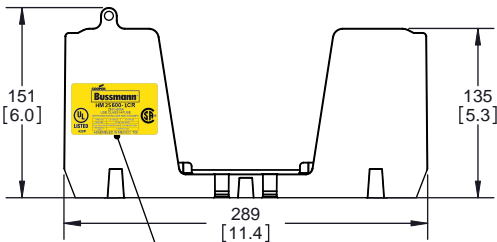
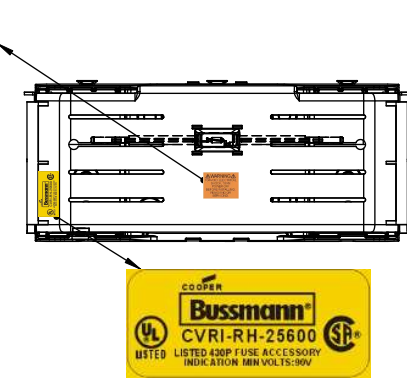

**CVR-RH-25600**

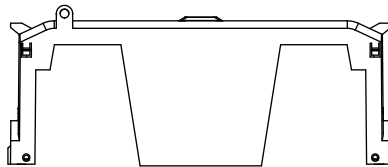

**CVRI-RH-25600**

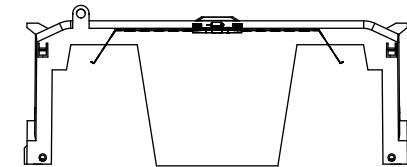

**COOPER Bussmann**  
**HM 25600-1CR**  
 250V-600A  
 USE CLASS H FUSE  
 WITHSTAND RATING: 10K RMS SYM AMPS

| WIRE SIZE       | CUT TORQUE         | AL TORQUE          |
|-----------------|--------------------|--------------------|
| 500 KCMIL       | 57 INM / 500 N-LBS |                    |
| DUAL 3/2-4 AWG  | 67 INM/500 IN-LBS  | 33.9 INM/300 N-LBS |
| 150 KCMIL-4 AWG | 51 INM/450 N-LBS   |                    |

UL LISTED 430P ASSEMBLED IN MEXICO T06

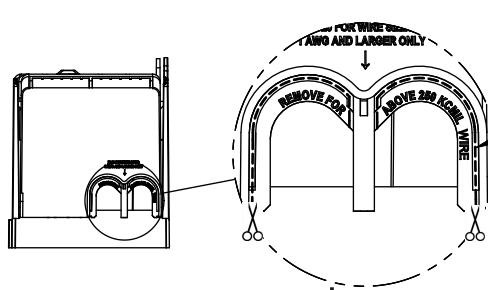
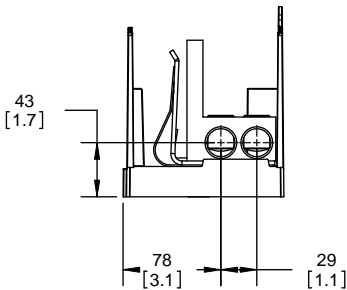

CUT OPEN ALONG THIS DOTTED LINE FOR WIRES ABOVE 250 KCMIL

**COOPER Bussmann**  
 St. Louis MO 63178

TITLE: **Class H fuse holder-CUST-250V**

SCALE: 1:1 SIZE: A3 SHEET: 12 OF 14



DESIGN UNITS: METRIC (mm)  
UNLESS OTHERWISE SPECIFIED  
[INCHES]

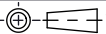

THIRD ANGLE PROJECTION

**HM25600-2CR**

**HM25600-2CR  
WITH CVR-RH-25600 INSTALLED**

**HM25600-2CR  
WITH CVRI-RH-25600 INSTALLED**

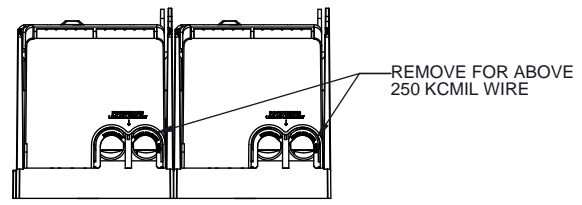
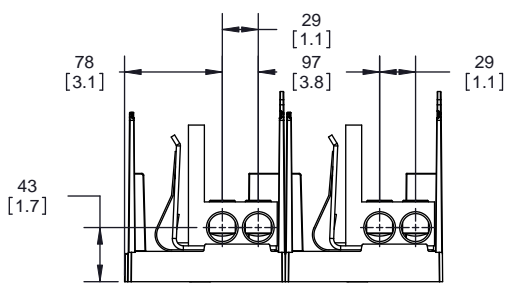
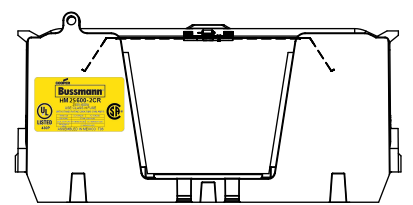
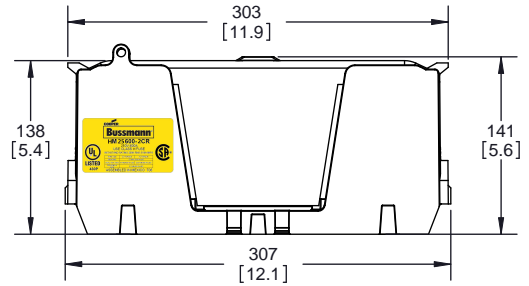
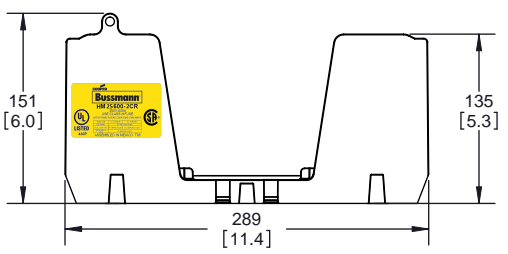
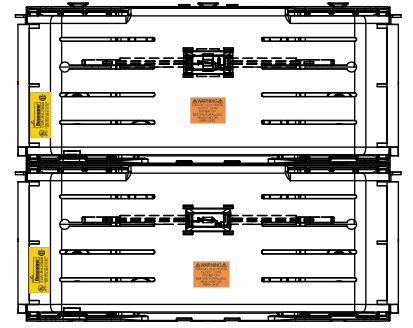
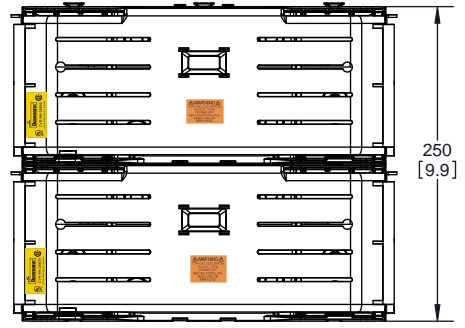
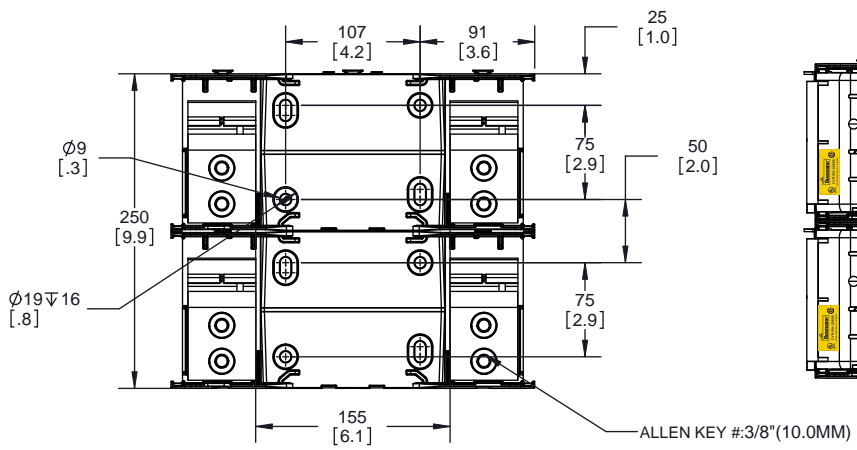

**COOPER Bussmann**  
St. Louis MO 63178

TITLE:  
**Class H fuse holder-CUST-250V**

SCALE: 1:1      SIZE: A3      SHEET: 13 OF 14

DESIGN UNITS: METRIC (mm)  
UNLESS OTHERWISE SPECIFIED  
[INCHES]

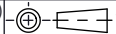

THIRD ANGLE PROJECTION

**HM25600-3CR**

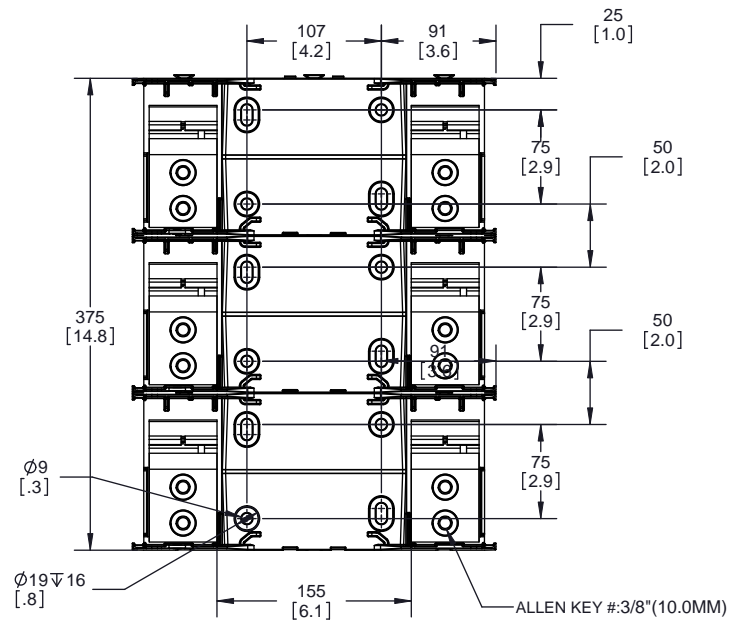

**HM25600-3CR  
WITH CVR-RH-25600 INSTALLED**

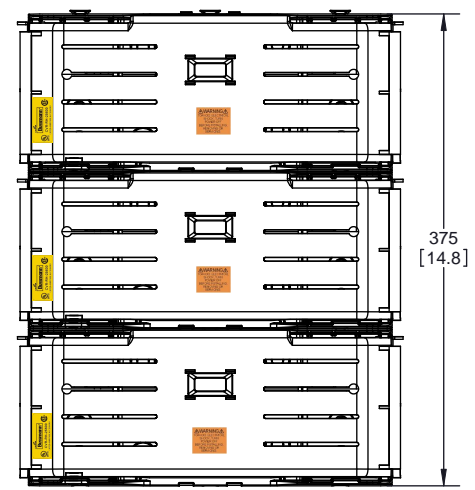

**HM25600-3CR  
WITH CVRI-RH-25600 INSTALLED**

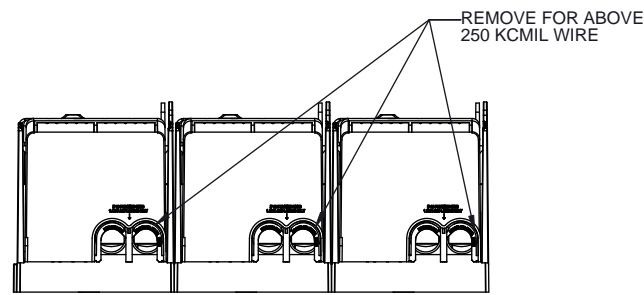
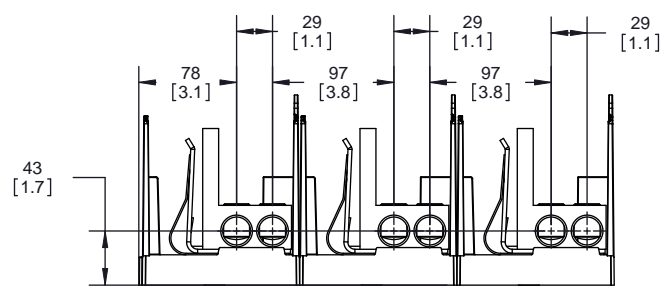
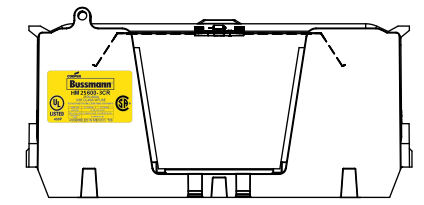
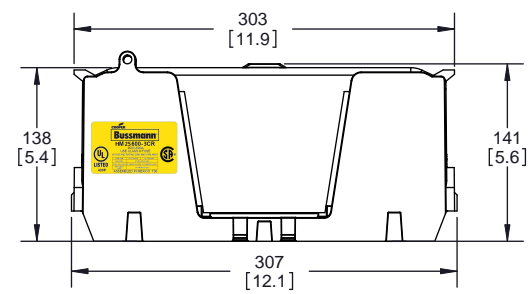
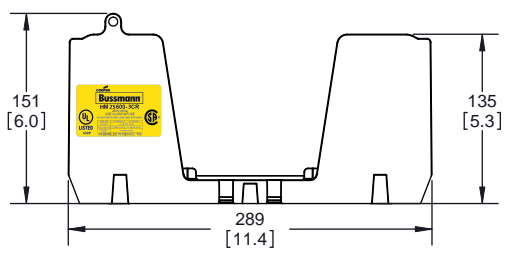
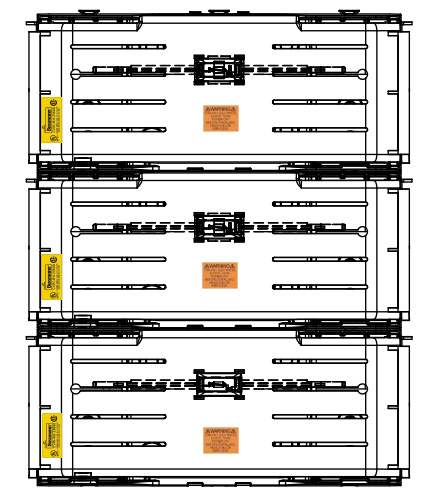

**COOPER Bussmann**  
St. Louis MO 63178

TITLE: **Class H fuse holder-CUST-250V**

SCALE: 1:1      SIZE: A3      SHEET: 14 OF 14

**HM60100-1CR**

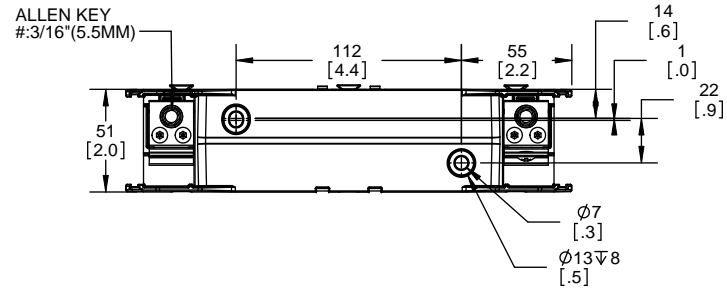

**HM60100-1CR WITH CVR-RH-60100 INSTALLED**

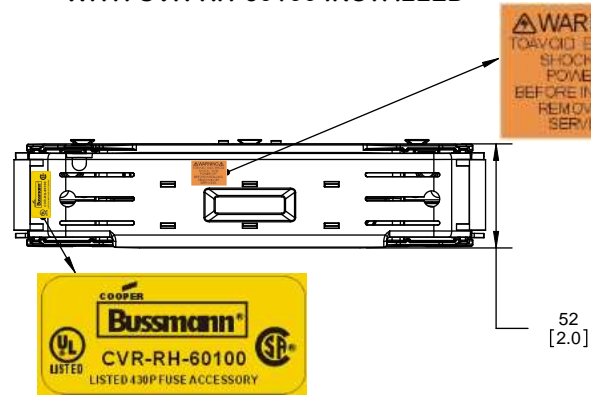

**HM60100-1CR WITH CVRI-RH-60100 INSTALLED**

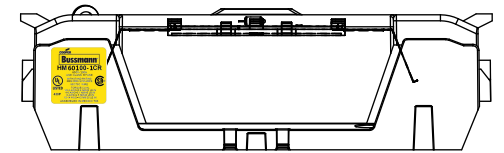
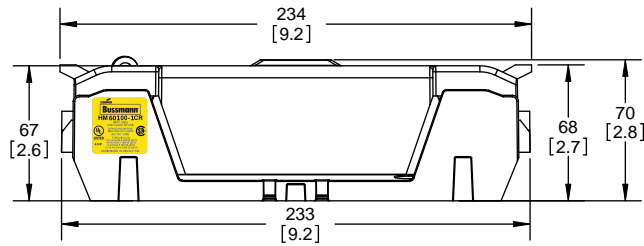
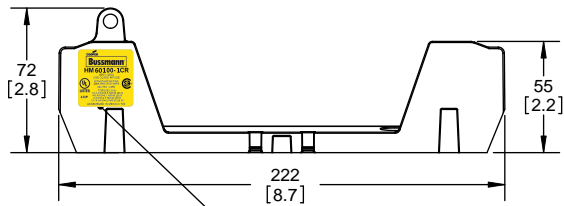
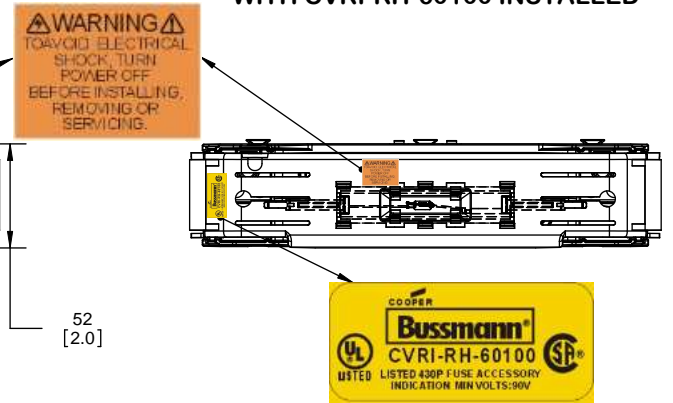

**CVR-RH-60100**

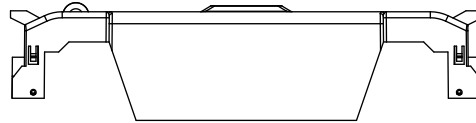

**CVRI-RH-60100**

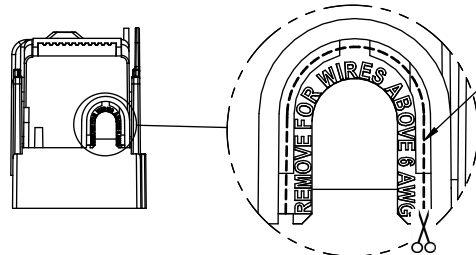
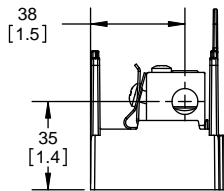
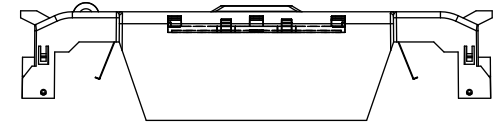

CUT OPEN ALONG THIS DOTTED LINE FOR WIRES ABOVE 6 AWG

**COOPER Bussmann**  
 St. Louis MO 63178

TITLE: **Class H fuse holder-CUST-600V**

SCALE: 1:1 SIZE: A3 SHEET: 1 OF 12

DESIGN UNITS: METRIC (mm)  
UNLESS OTHERWISE SPECIFIED  
[INCHES]

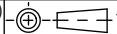

THIRD ANGLE PROJECTION

| REVISIONS |      |             |  | DATE | ECN | BY |
|-----------|------|-------------|--|------|-----|----|
| REV       | ZONE | DESCRIPTION |  |      |     |    |
|           |      |             |  |      |     |    |

**HM60100-2CR**

**HM60100-2CR  
WITH CVR-RH-60100 INSTALLED**

**HM60100-2CR  
WITH CVRI-RH-60100 INSTALLED**

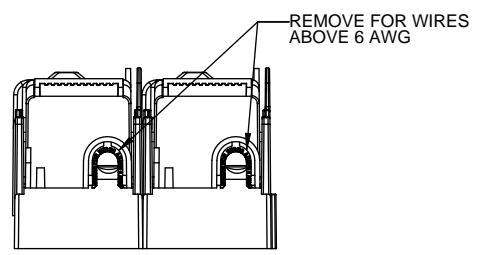
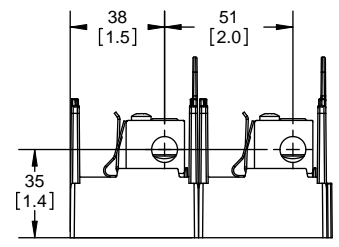
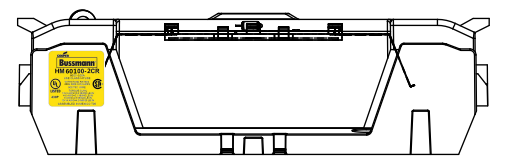
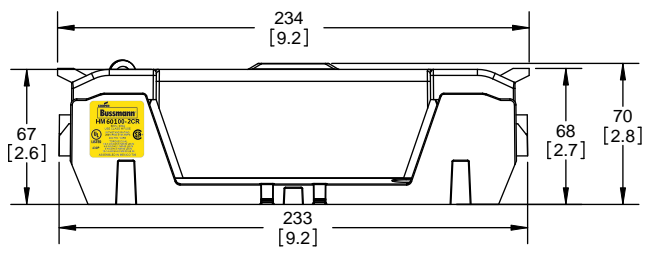
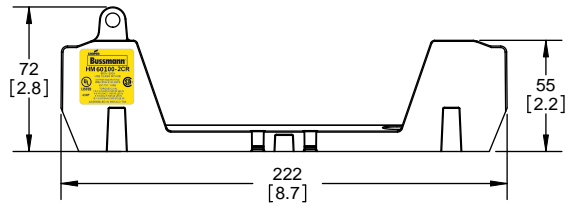
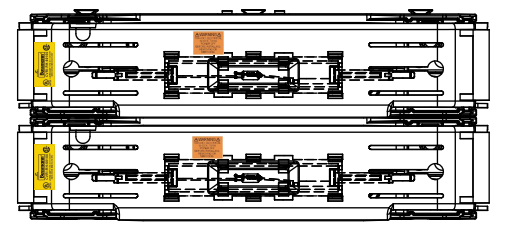
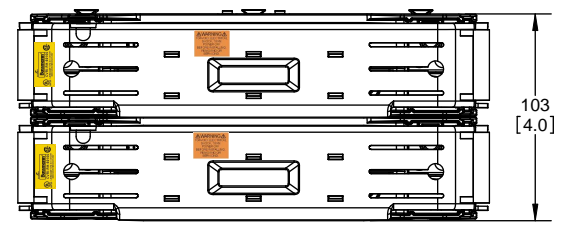
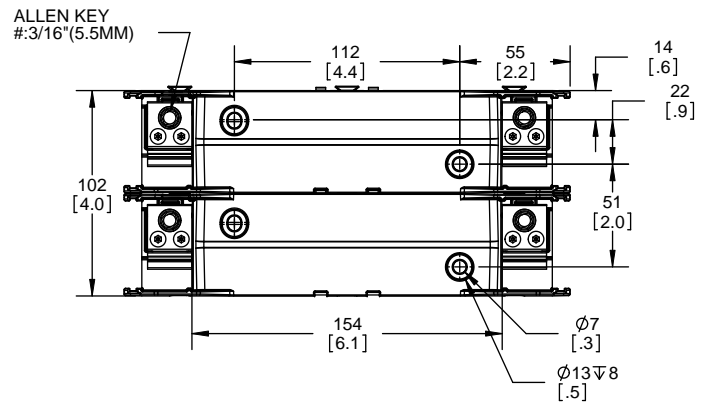

**COOPER Bussmann**  
St. Louis MO 63178

TITLE:  
**Class H fuse holder-CUST-600V**

SCALE: 1:1    SIZE: A3    SHEET: 2 OF 12

| REVISIONS |      |             | DATE | ECN | BY |
|-----------|------|-------------|------|-----|----|
| REV       | ZONE | DESCRIPTION |      |     |    |

**HM60100-3CR**

**HM60100-3CR  
WITH CVR-RH-60100 INSTALLED**

**HM60100-3CR  
WITH CVRI-RH-60100 INSTALLED**

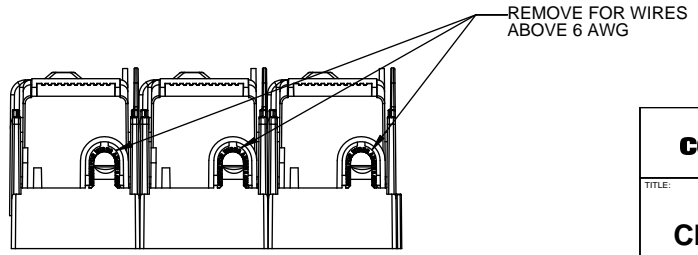
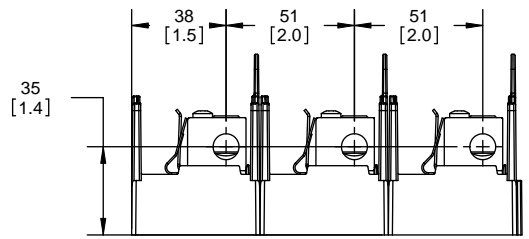
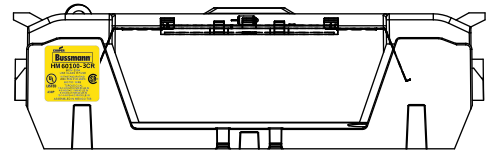
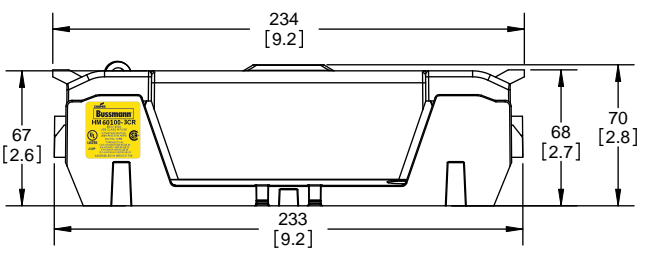
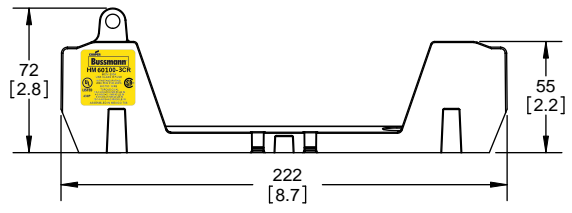
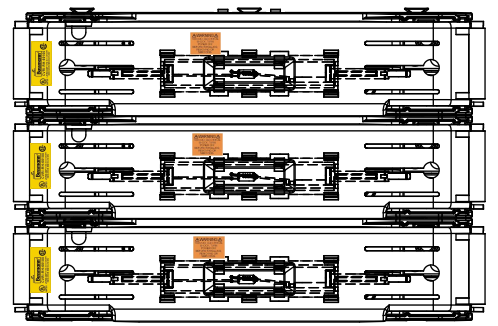
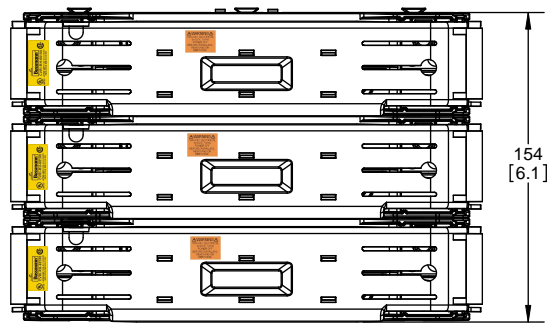
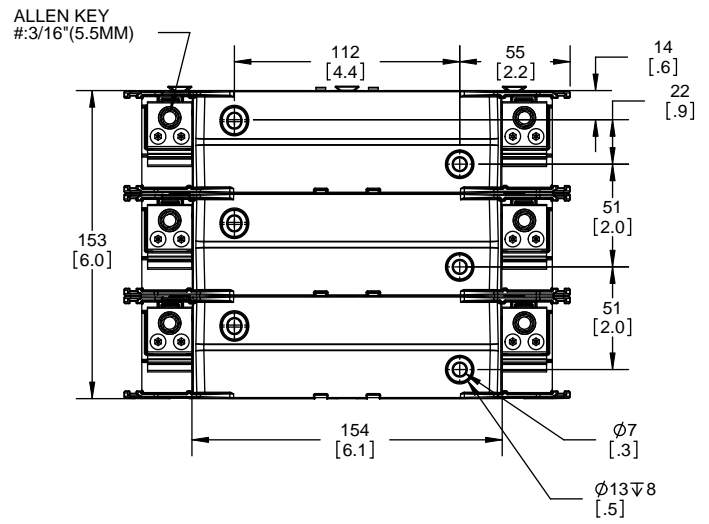

**COOPER Bussmann**  
St. Louis MO 63178

TITLE:  
**Class H fuse holder-CUST-600V**

SCALE: 1:1      SIZE: A3      SHEET: 3 OF 12

| REVISIONS |      |             |  | DATE | ECN | BY |
|-----------|------|-------------|--|------|-----|----|
| REV       | ZONE | DESCRIPTION |  |      |     |    |

**HM60200-1CR**

**HM60200-1CR WITH CVR-RH-60200 INSTALLED**

**HM60200-1CR WITH CVRI-RH-60200 INSTALLED**

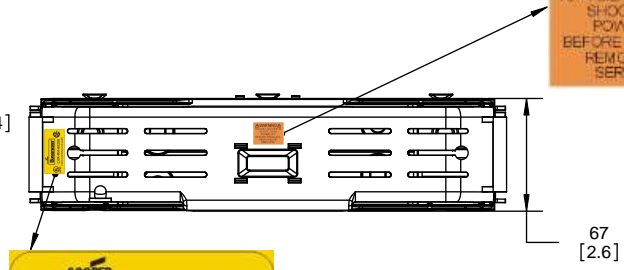
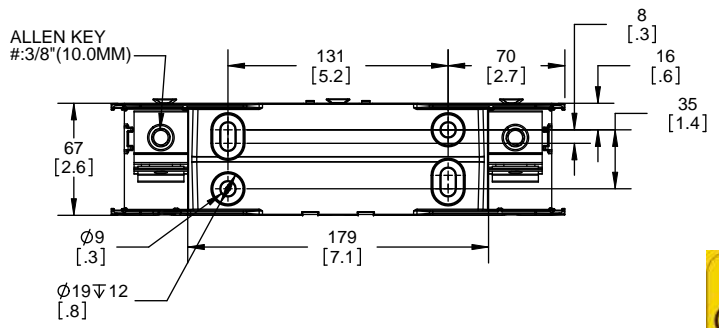

**WARNING**  
TO AVOID ELECTRICAL SHOCK, TURN POWER OFF BEFORE INSTALLING, REMOVING OR SERVICING.

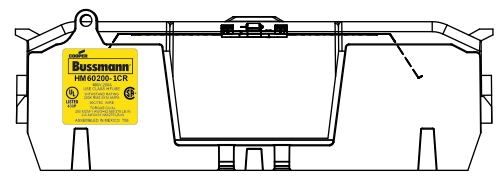
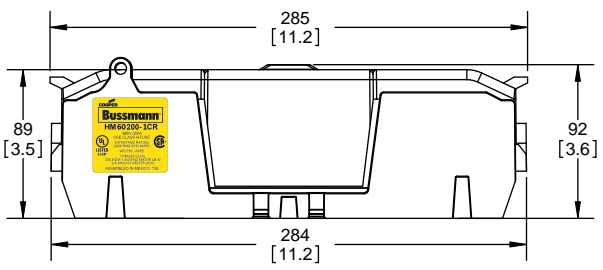
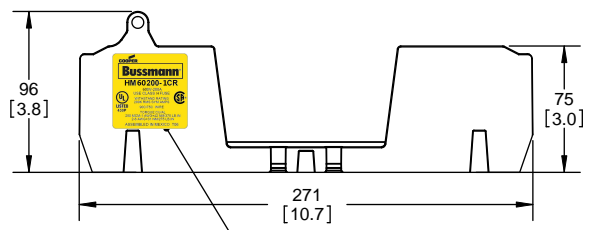
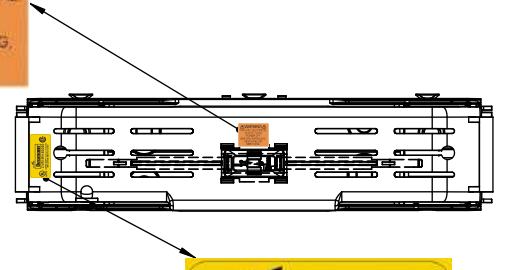

**CVR-RH-60200**

**CVRI-RH-60200**

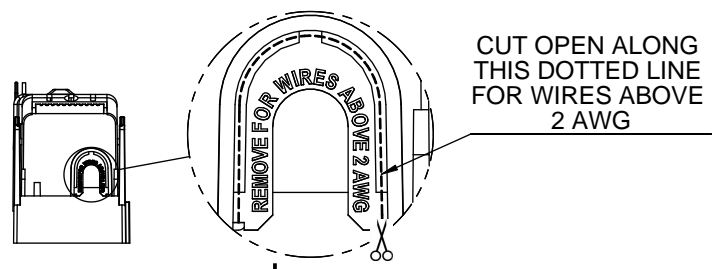
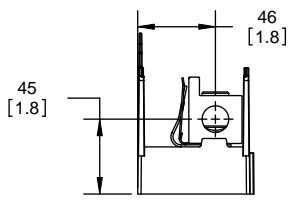
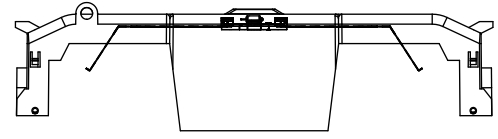
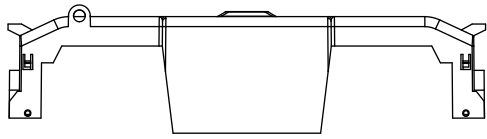

**COOPER Bussmann**  
St. Louis MO 63178

TITLE: **Class H fuse holder-CUST-600V**

SCALE: 1:1      SIZE: A3      SHEET: 4 OF 12

**HM60200-2CR**

**HM60200-2CR  
WITH CVR-RH-60200 INSTALLED**

**HM60200-2CR  
WITH CVRI-RH-60200 INSTALLED**

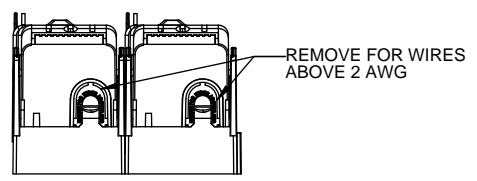
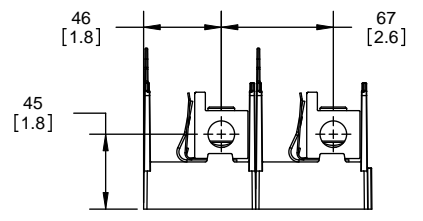
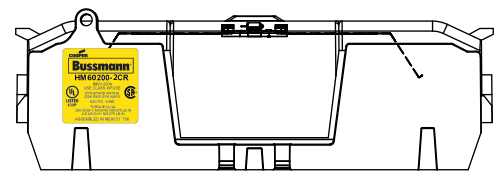
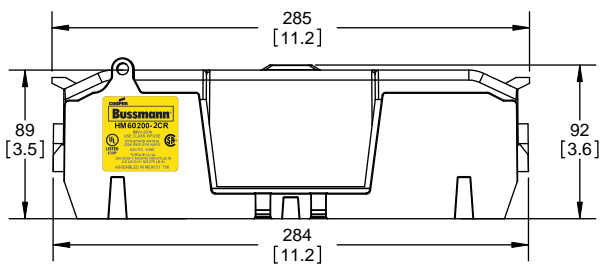
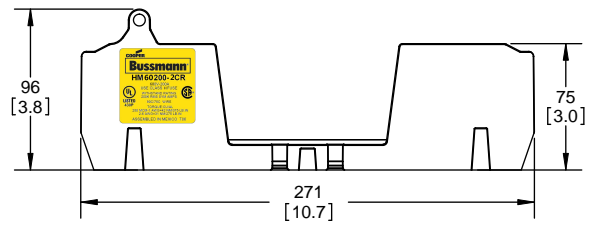
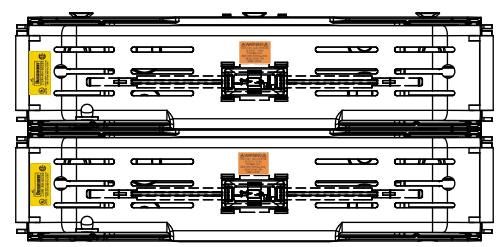
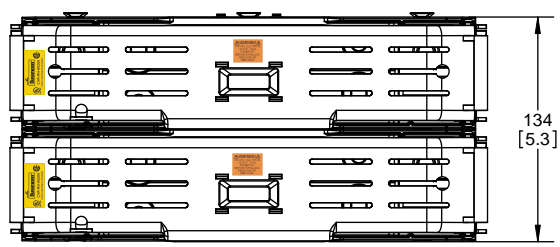
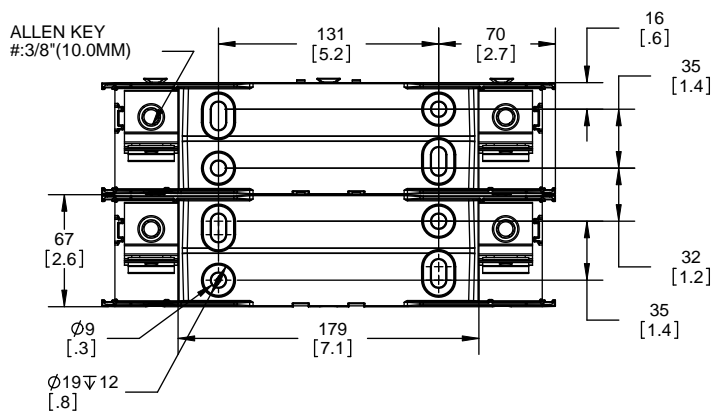

**COOPER Bussmann**  
St. Louis MO 63178

TITLE:  
**Class H fuse holder-CUST-600V**

SCALE: 1:1 SIZE: A3 SHEET: 5 OF 12

A

**HM60200-3CR**                      **HM60200-3CR WITH CVR-RH-60200 INSTALLED**                      **HM60200-3CR WITH CVRI-RH-60200 INSTALLED**

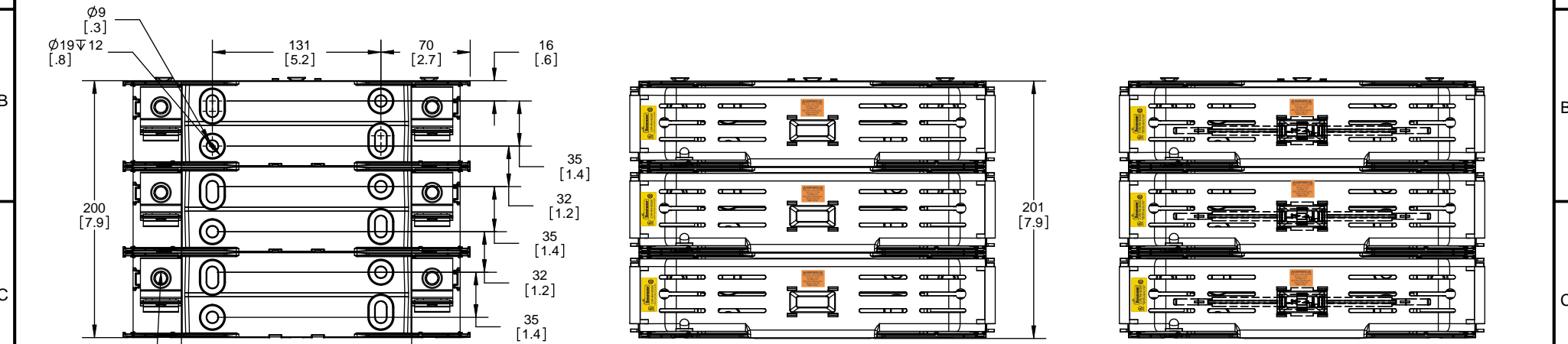

ALLEN KEY #: 3/8" (10.0MM)

B

C

**HM60200-3CR**                      **HM60200-3CR WITH CVR-RH-60200 INSTALLED**                      **HM60200-3CR WITH CVRI-RH-60200 INSTALLED**

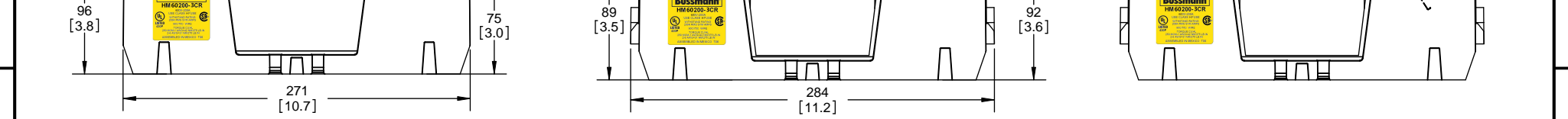

D

E

**HM60200-3CR**                      **HM60200-3CR WITH CVR-RH-60200 INSTALLED**                      **HM60200-3CR WITH CVRI-RH-60200 INSTALLED**

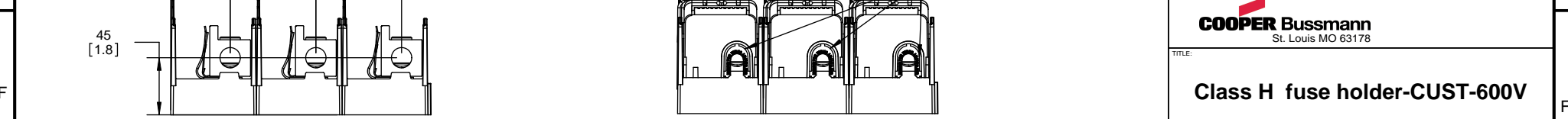

F

**COOPER Bussmann**  
St. Louis MO 63178

TITLE: **Class H fuse holder-CUST-600V**

SCALE: 1:1      SIZE: A3      SHEET: 6 OF 12

Drawing template A3 - Rev 05



**HM60400-1CR**



**HM60400-1CR WITH CVR-RH-60400 INSTALLED**



**HM60400-1CR WITH CVRI-RH-60400 INSTALLED**

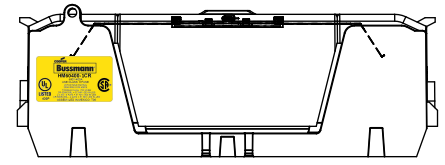
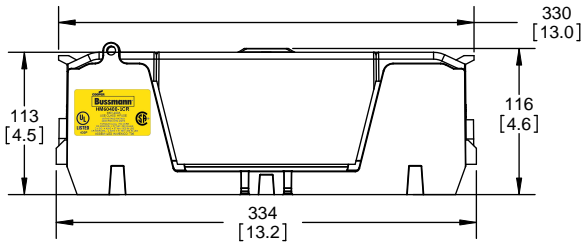
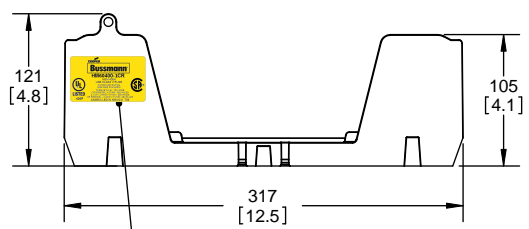

**COOPER Bussmann HM60400-1CR**  
600V-400A  
USE CLASS H FUSE  
WITHSTAND RATING  
10K RMS SYM AMPS  
TORQUE: CU/AL 75C WIRE  
CR 600KCMIL = 57 NM / 500 IN-LBS  
2 x 3/0 - 4 AWG = 57 NM / 500 IN-LBS  
CR 500KCMIL - 4 AWG = 51 NM / 450 IN-LBS  
ASSEMBLED IN MEXICO T06

**UL LISTED 430P**

**CVR-RH-60400**

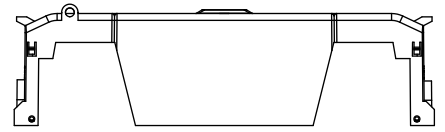

**CVRI-RH-60400**



CUT OPEN ALONG THIS DOTTED LINE FOR WIRES ABOVE 250 KCMIL

**COOPER Bussmann**  
St. Louis MO 63178

TITLE:  
**Class H fuse holder-CUST-600V**

SCALE: 1:1 SIZE: A3 SHEET: 7 OF 12

DESIGN UNITS: METRIC (mm)  
UNLESS OTHERWISE SPECIFIED [INCHES]

THIRD ANGLE PROJECTION

| REVISIONS |      |             | DATE | ECN | BY |
|-----------|------|-------------|------|-----|----|
| REV       | ZONE | DESCRIPTION |      |     |    |

**HM60400-2CR**



**HM60400-2CR  
WITH CVR-RH-60400 INSTALLED**



**HM60400-2CR  
WITH CVRI-RH-60400 INSTALLED**

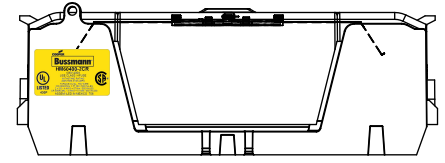
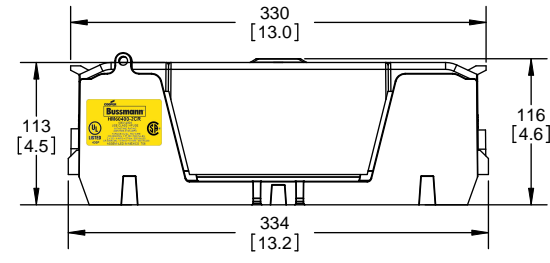
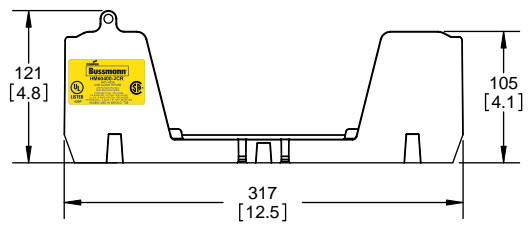

**COOPER Bussmann**  
St. Louis MO 63178

TITLE:  
**Class H fuse holder-CUST-600V**

SCALE: 1:1    SIZE: A3    SHEET: 8 OF 12

| REVISIONS |      |             | DATE | ECN | BY |
|-----------|------|-------------|------|-----|----|
| REV       | ZONE | DESCRIPTION |      |     |    |

**HM60400-3CR**

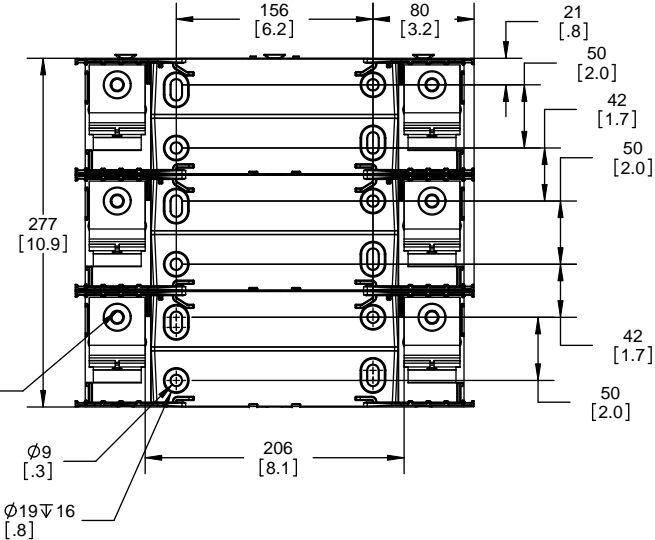

**HM60400-3CR  
WITH CVR-RH-60400 INSTALLED**

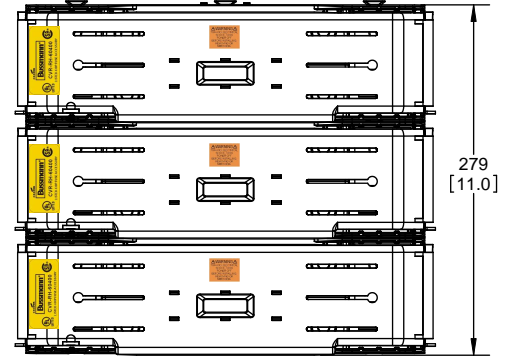

**HM60400-3CR  
WITH CVRI-RH-60400 INSTALLED**

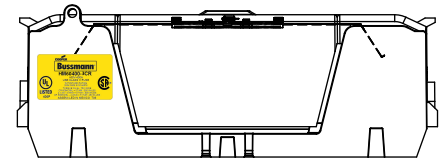
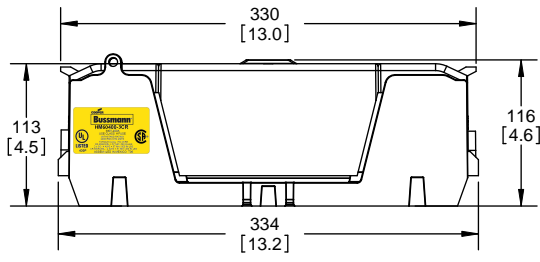
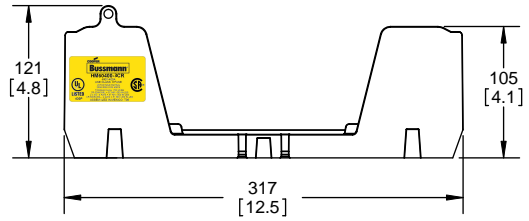
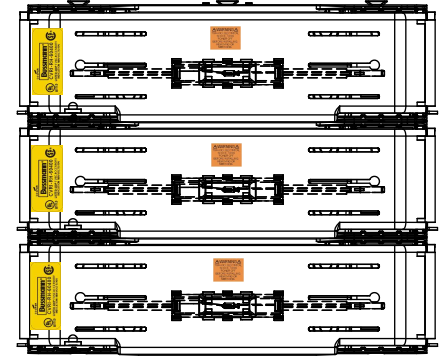

**COOPER Bussmann**  
St. Louis MO 63178

TITLE:  
**Class H fuse holder-CUST-600V**

SCALE: 1:1      SIZE: A3      SHEET: 9 OF 12

**HM60600-1CR**

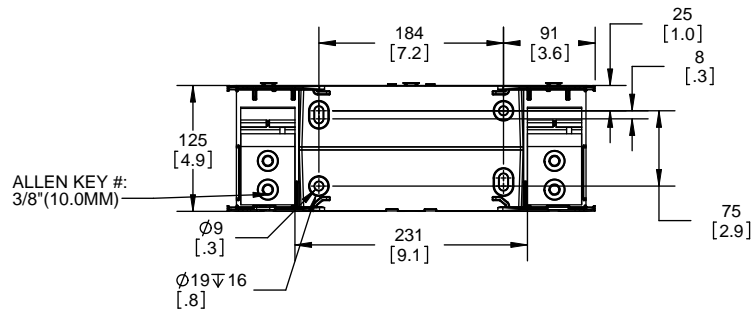

**HM60600-1CR WITH CVR-RH-60600 INSTALLED**

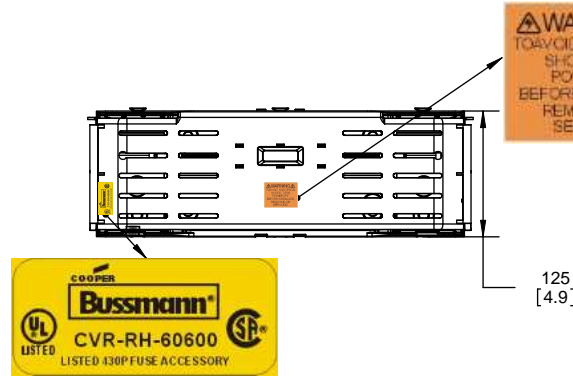

**HM60600-1CR WITH CVRI-RH-60600 INSTALLED**

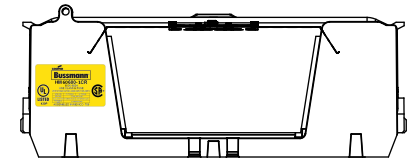
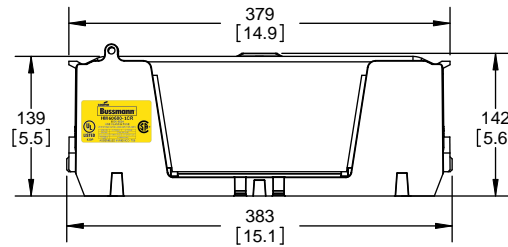
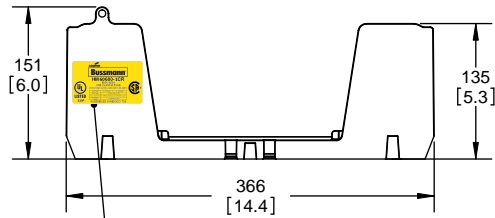
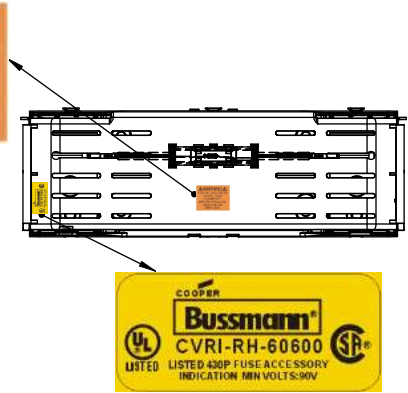

**CVR-RH-60600**

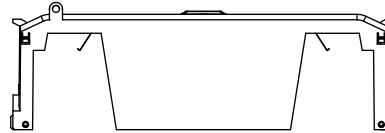

**CVRI-RH-60600**

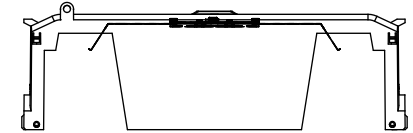

**COOPER Bussmann**  
**HM 60600-1CR**  
 600V-600A  
 USE CLASS H FUSE  
 WITHSTAND RATING: 10K RMS SYM AMPS

| WIRE SIZE       | CUT TORQUE         | AL TORQUE          |
|-----------------|--------------------|--------------------|
| 500 KCMIL       | 57 NM / 500 IN-LBS |                    |
| DUAL 3/0-4 AWG  | 57 NM/500 IN-LBS   | 33.9 NM/300 IN-LBS |
| 500 KCMIL-4 AWG | 51 NM/450 IN-LBS   |                    |

UL LISTED 430P ASSEMBLED IN MEXICO T06 SA

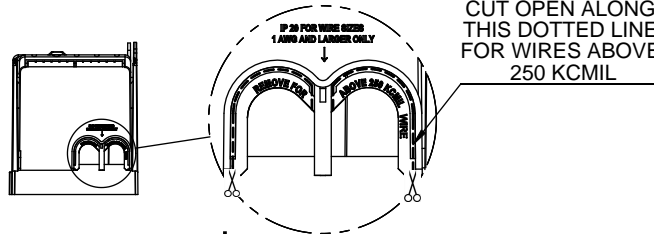
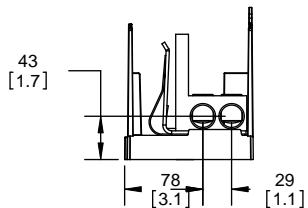

**COOPER Bussmann**  
 St. Louis MO 63178

TITLE: **Class H fuse holder-CUST-600V**

SCALE: 1:5 SIZE: A3 SHEET: 10 OF 12

**HM60600-2CR**

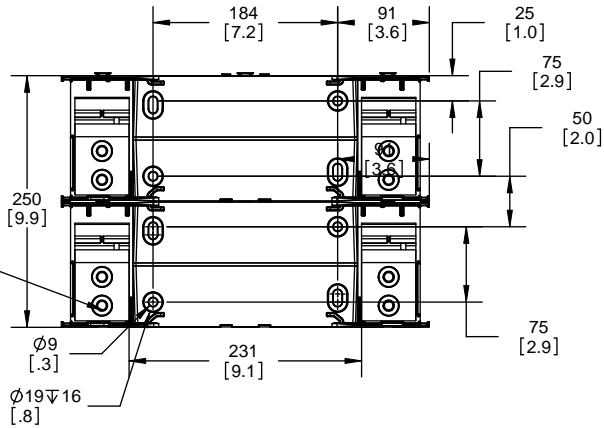

ALLEN KEY #:  
3/8" (10.0MM)

**HM60600-2CR  
WITH CVR-RH-60600 INSTALLED**

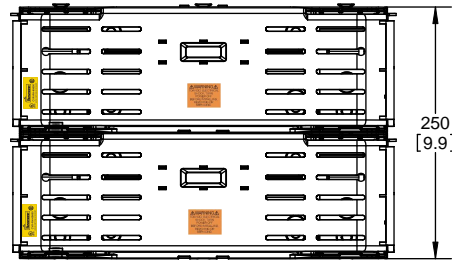

**HM60600-2CR  
WITH CVRI-RH-60600 INSTALLED**

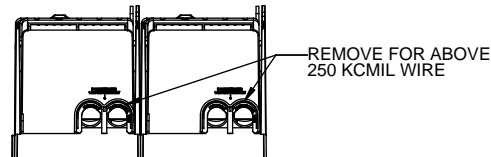
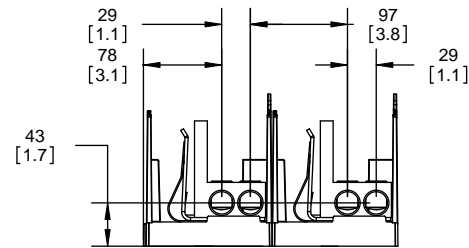
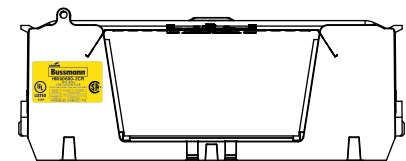
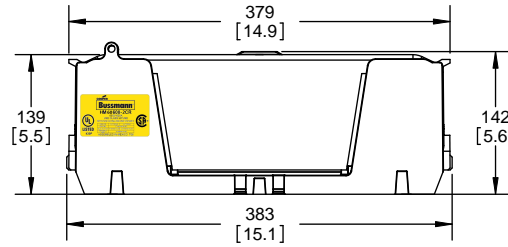
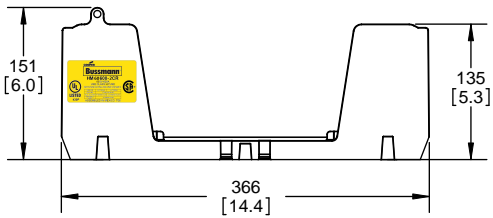
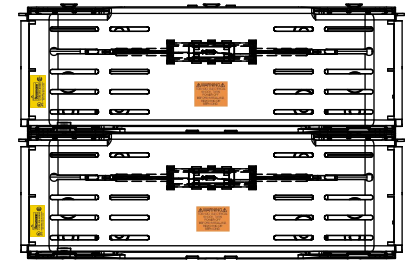

**COOPER Bussmann**  
St. Louis MO 63178

TITLE:  
**Class H fuse holder-CUST-600V**

SCALE: 1:5      SIZE: A3      SHEET: 11 OF 12

**HM60600-3CR**

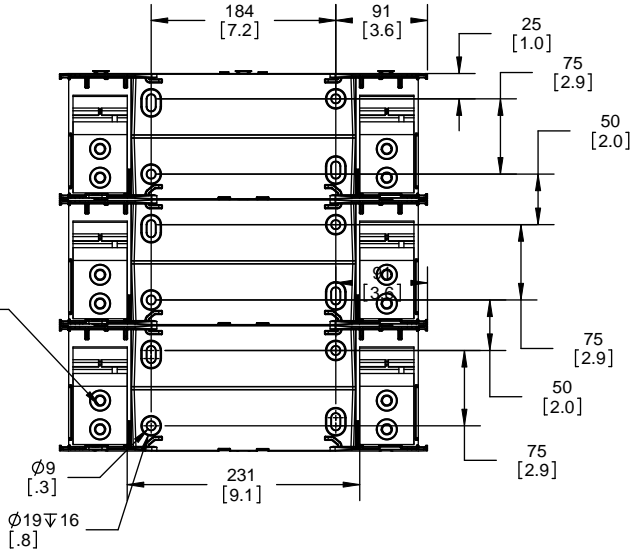

**HM60600-3CR  
WITH CVR-RH-60600 INSTALLED**

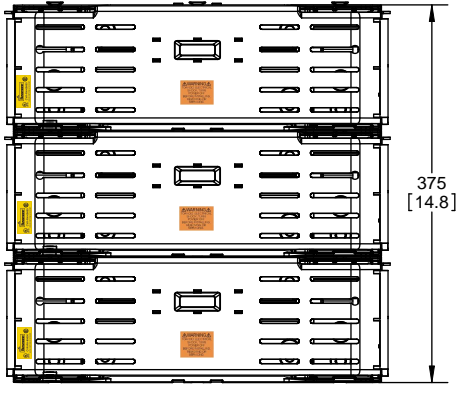

**HM60600-3CR  
WITH CVRI-RH-60600 INSTALLED**

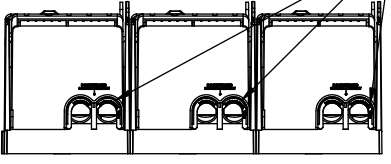
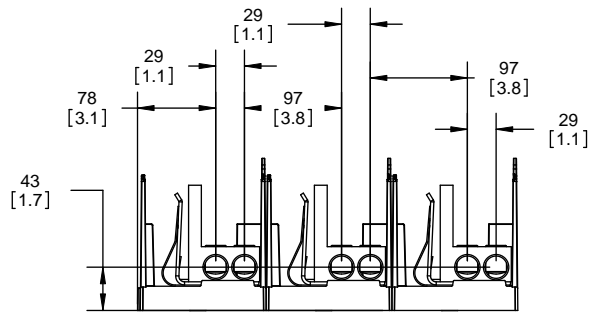
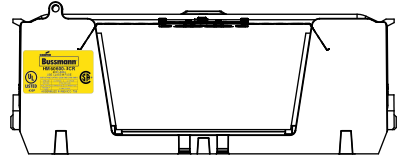
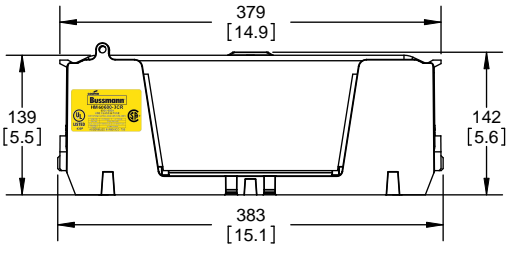
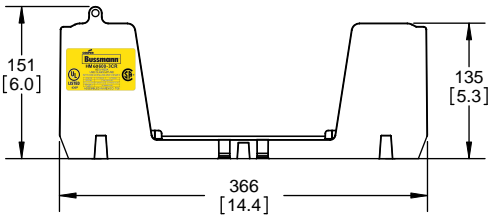
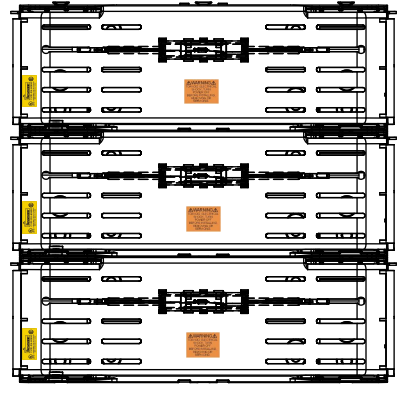

REMOVE FOR ABOVE  
250 KCMIL WIRE

**COOPER Bussmann**  
St. Louis MO 63178

TITLE:  
**Class H fuse holder-CUST-600V**

SCALE: 1:5      SIZE: A3      SHEET: 12 OF 12