

THIS DRAWING IS UNPUBLISHED. RELEASED FOR PUBLICATION
 © COPYRIGHT - BY TYCO ELECTRONICS CORPORATION. ALL RIGHTS RESERVED.

LOC	DIST	REVISIONS					
FT	0	P	LTR	DESCRIPTION	DATE	DWN	APVD
			A	REVISED PER ECO-06-15651	7/5/06	SS	SRY

NOTES:

- 1. MATERIAL: TIN PLATED, COPPER ALLOY.
- 2. FOR USE WITH SSB6, SSB7, JC6 & NC6 BARRIER STRIPS.

DOUBLE SIDED

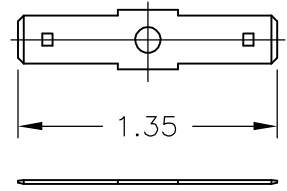

ITEM #1 - CAT NO. QC-20
TOP HARDWARE CODE - 20

SINGLE SIDED

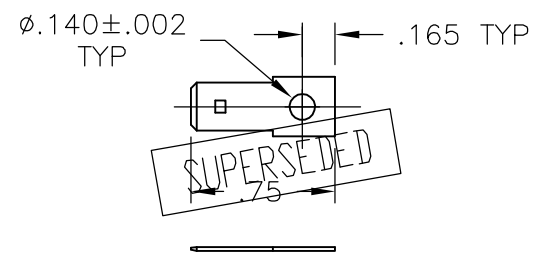

ITEM #4 - CAT NO. QC-23
TOP HARDWARE CODE - 23

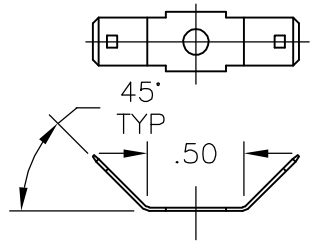

ITEM #2 - CAT NO. QC-21
TOP HARDWARE CODE - 21

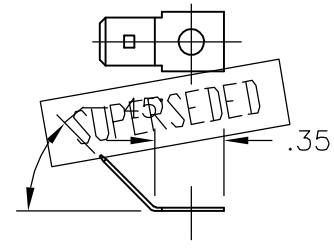

ITEM #5 - CAT NO. QC-24
TOP HARDWARE CODE - 24

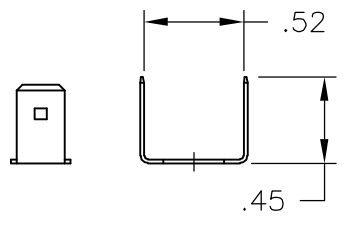

ITEM #3 - CAT NO. QC-22
TOP HARDWARE CODE - 22

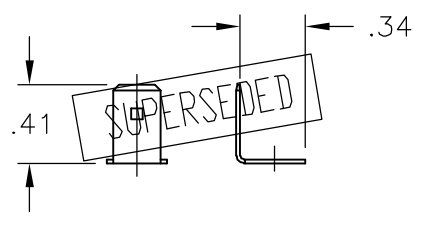

ITEM #6 - CAT NO. QC-25
TOP HARDWARE CODE - 25

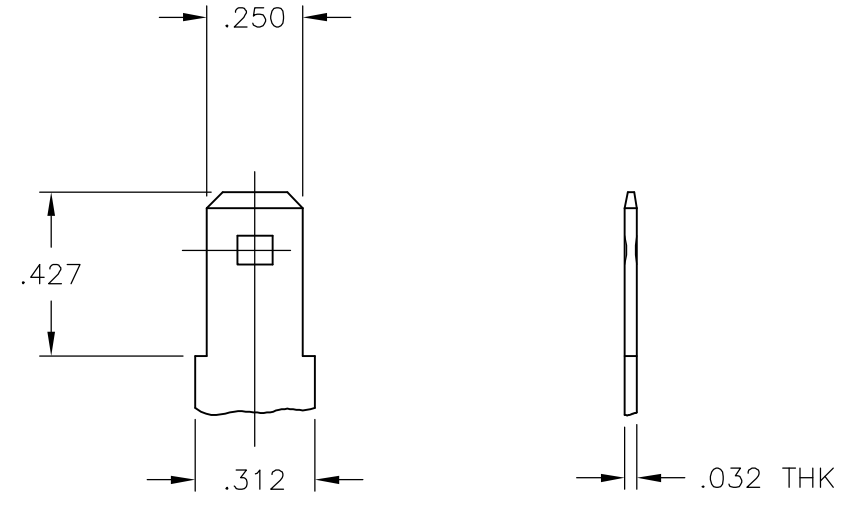

DETAIL OF MALE TAB
SCALE 4:1

SUPERSEDED	S.S. 90°	QC-25	6-1437402-7	6
SUPERSEDED	S.S. 45°	QC-24	6-1437402-6	5
SUPERSEDED	S.S. FLAT	QC-23	6-1437402-5	4
	D.S. 90°	QC-22	6-1437402-4	3
	D.S. 45°	QC-21	6-1437418-6	2
	D.S. FLAT	QC-20	6-1437402-3	1
	DESCRIPTION	CAT NO.	PART NO.	ITEM NO.

THIS DRAWING IS A CONTROLLED DOCUMENT.		DWN S SCHLEGEL 17DEC02	Tyco Electronics Corporation Harrisburg, PA 17105-3608	
DIMENSIONS: INCHES		CHK S YODER 12/17/02		
TOLERANCES UNLESS OTHERWISE SPECIFIED:		APVD S YODER 12/17/02	NAME	
0 PLC ± - 1 PLC ± - 2 PLC ± .01 3 PLC ± .005 4 PLC ± - ANGLES ± .5°		PRODUCT SPEC	QUICK CONNECT TABS .250 WIDE X .032 THICK	
MATERIAL		APPLICATION SPEC	SIZE	RESTRICTED TO
- ⚠		FINISH	—	—
		WEIGHT	A3 00779	—
		CUSTOMER DRAWING	CAGE CODE	—
			G=6-1437402-3	—
			DRAWING NO	—
			SCALE 2:1	—
			SHEET 1 OF 1	—
			REV A	—