

嵌合図
MATED CONNECTORS

NOTES

1. 嵌合相手: 502380-****
MATE WITH: 502380-****
2. 端子テール部 及び ネイルの平坦度: 0.1MAX.
TAIL AND NAIL COPLANARITY TO BE 0.1 MAX.
3. 極数/2=偶数に適用。
APPLY FOR CKT. SIZE / 2 = EVEN.
4. 端子テール部 及び ネイルに錫めっきを使用しているため、
外観に摺動痕が付く場合がございます。
BECAUSE THE TIN PLATING MIGHT BE USED FOR THE TAIL AND NAIL.
5. 本製品のプラスチック部に黒点等が確認される場合や
色合いが異なる場合がありますが、製品性能に影響はありません。
THERE IS NO INFLUENCE IN THE PRODUCT PERFORMANCE THOUGH
THE BLACK SPOT ETC. MIGHT BE CONFIRMED TO THE PLASTIC PART
OF THIS PRODUCT AND THE SHADE MIGHT BE DIFFERENT.
6. ELV AND ROHS COMPLIANT.

2	10.7	11.5	17.5	21	22.1	502386-1571	502386-1507	15
2	9.45	10.25	16.25	19.75	20.85	502386-1471	502386-1407	14
2	8.2	9	15	18.5	19.6	502386-1371	502386-1307	13
2	6.95	7.75	13.75	17.25	18.35	502386-1271	502386-1207	12
2	5.7	6.5	12.5	16	17.1	502386-1171	502386-1107	11
2	4.45	5.25	11.25	14.75	15.85	502386-1071	502386-1007	10
2	3.2	4	10	13.5	14.6	502386-0971	502386-0907	9
2.6	1.95	2.75	8.75	12.25	13.35	502386-0871	502386-0807	8
F	E	D	C	B	A	EMBOSSED TAPE ORDER No.	製品番号 MATERIAL NO.	極数 (CKT. NO.)

番号 NO.	部品 PART	材質 MATERIAL
①	ハウジング HOUSING	耐熱性樹脂 UL94V-0 色: ナチュラル HEATPROOF RESIN UL94V-0 COLOR:NATURAL
②	ターミナル TERMINAL	銅合金 COPPER ALLOY 金めっき: 0.1 micro-meter MIN. GOLD ニッケルめっき(下地): 1.0 micro-meter MIN. NICKEL (UNDER PLATING)
③	ネイル NAIL	銅合金 COPPER ALLOY 錫めっき: 1.0 micro-meter MIN. TIN ニッケルめっき(下地): 1.0 micro-meter MIN. NICKEL (UNDER PLATING)

REVISED EC NO: J2016-0012 DRWN:TAKAIKE 2015/07/24 CHKD:KASAKAWA 2015/07/03 APPR:NUKITA 2015/07/21	GENERAL TOLERANCES (UNLESS SPECIFIED)		DIMENSION STYLE MM ONLY		SCALE	DESIGN UNITS METRIC	THIRD ANGLE PROJECTION
	0.25 UNDER	UNDER	±0.03	DRAWN BY Y.AOYAGI	DATE 2008/10/16	TITLE 1.25 W/B CONN. SINGLE R/A REC. ASS'Y 8-15CKT.	
	0.25 OVER	0.5 UNDER	±0.05	CHECKED BY T.HARUYAMA	DATE 2008/10/16		
	0.5 OVER	1.0 UNDER	±0.1	APPROVED BY N.UKITA	DATE 2008/10/16		
1.0 OVER	30 UNDER	±0.2	MATERIAL NO.		DOCUMENT NO. SD-502386-004	SHEET NO. 1 OF 2	
30 OVER		±0.3	SIZE A3		THIS DRAWING CONTAINS INFORMATION THAT IS PROPRIETARY TO MOLEX INCORPORATED AND SHOULD NOT BE USED WITHOUT WRITTEN PERMISSION		
ANGULAR		±3 °	DRAFT WHERE APPLICABLE MUST REMAIN WITHIN DIMENSIONS				

10 9 8 7 6 5 4 3 2 1

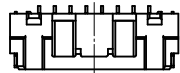

8 CKT.



12 CKT.

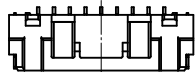

9 CKT.

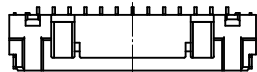

13 CKT.

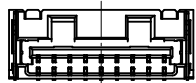

10 CKT.

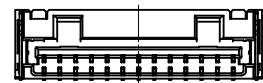

14 CKT.

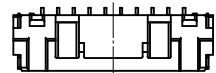

11 CKT.



15 CKT.

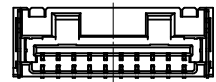

極数の種類

KIND OF CKT. NO. (FRONT VIEW)

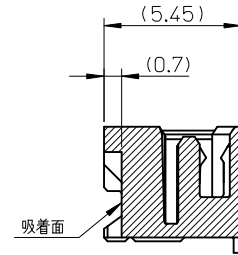
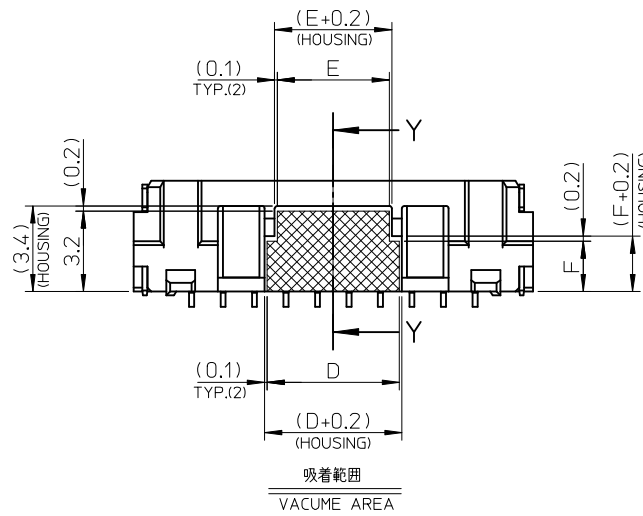

SECTION Y-Y

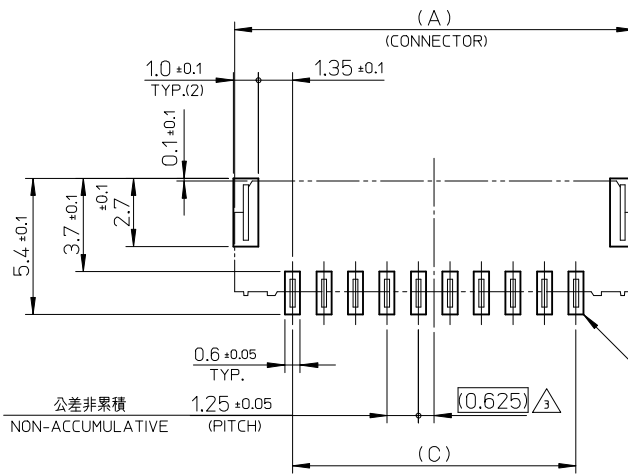

回路番号 1
CKT. NO. 1

基板パターンレイアウト (参考)

RECOMMENDED P.C.B. PATTERN LAYOUT (REF.)

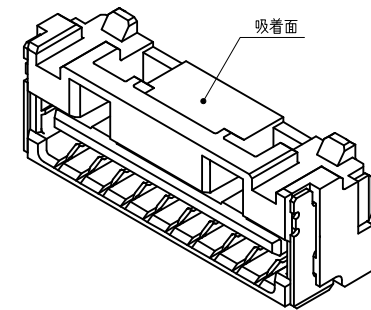

REVISED EC NO: J2016-0012 DRWN:TAKAIKE 2015/07/24 CHKD:KASAKAWA 2015/07/27 APPR:NUKITA 2015/07/27	GENERAL TOLERANCES (UNLESS SPECIFIED)		DIMENSION STYLE MM ONLY		SCALE	DESIGN UNITS METRIC	THIRD ANGLE PROJECTION	
	0.25 UNDER	UNDER	±0.03	DRAWN BY	DATE	TITLE		
	0.25 OVER	0.5 UNDER	±0.05	Y. AOYAGI	2008/10/17	1.25 W/B CONN. SINGLE R/A REC. ASS'Y 8-15CKT.		
	0.5 OVER	1.0 UNDER	±0.1	T. HARUYAMA	2008/10/17			
	1.0 OVER	10 UNDER	±0.2	N. UKITA	2008/10/17			
30 OVER	30 UNDER	±0.25	SEE TABLE		SD-502386-004		2 OF 2	
ANGULAR	±3 °	±0.3	THIS DRAWING CONTAINS INFORMATION THAT IS PROPRIETARY TO MOLEX INCORPORATED AND SHOULD NOT BE USED WITHOUT WRITTEN PERMISSION					

9 8 7 6 5 4 3 2 1

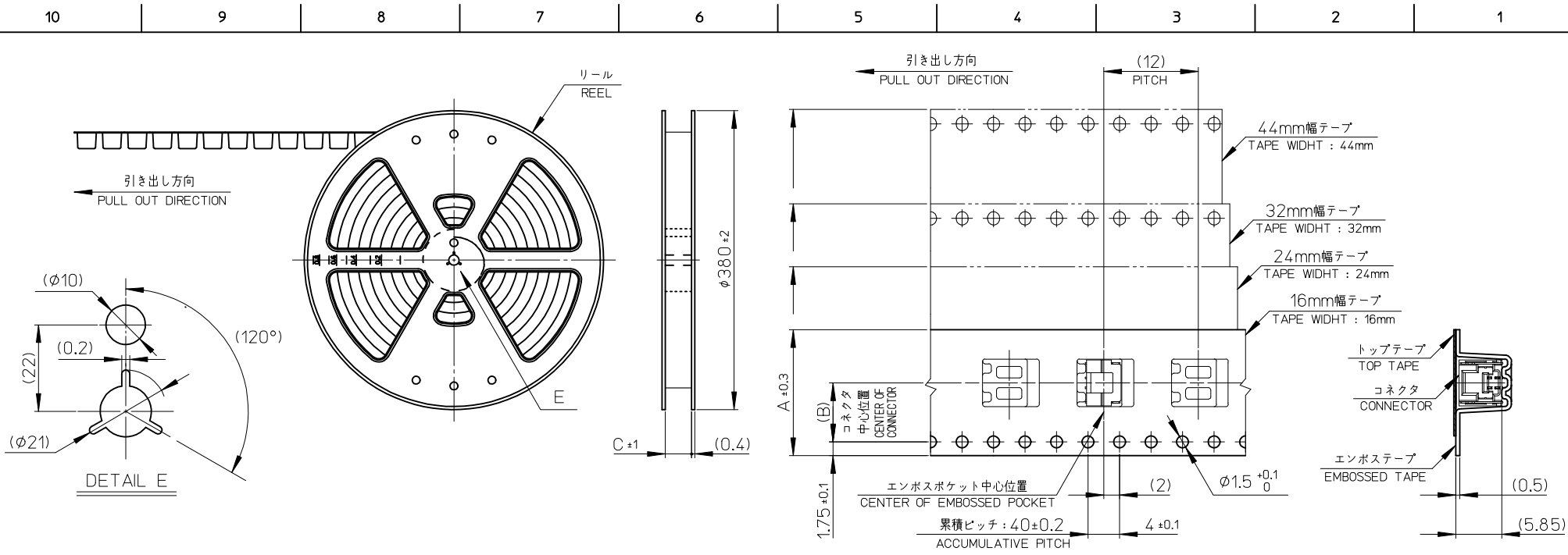

NOTES

- 製品詳細寸法は製品単体図面を参照して下さい。
FOR DETAIL OF CONNECTOR DIMENSIONS, PLEASE SEE THE DRAWING OF CONNECTOR ITSELF (NOT PACKAGED).
- 梱包数量 : 1200個
NUMBER OF CONNECTORS : 1200 PIECES/REEL.
- リードテープ長さ
LEAD TAPE LENGTH

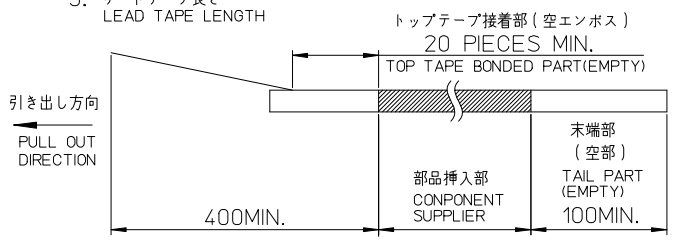

- 材料
MATERIAL
キャリアテープ : ポリスチレン
CARRIER TAPE : POLYSTYRENE
トップテープ : ポリエステル, ポリエチレン, ポリエチレンテレフタレート
TOP TAPE : POLYESTER, POLYETHYLENE, POLYETHYLENE TEREPHTHALATE
リール : ポリスチレン <リサイクル材を含む>
REEL : POLYSTYRENE <RECYCLE MATERIAL CONTAINED>
- ELV 及び RoHS 適合品
ELV AND ROHS COMPLIANT

45.5	20.2	44	502386-1507	502386-1571	502386-***71	15
45.5	20.2	44	502386-1407	502386-1471		14
33.5	14.2	32	502386-1307	502386-1371		13
33.5	14.2	32	502386-1207	502386-1271		12
33.5	14.2	32	502386-1107	502386-1171		11
33.5	14.2	32	502386-1007	502386-1071		10
25.5	11.5	24	502386-0907	502386-0971		9
25.5	11.5	24	502386-0807	502386-0871		8
25.5	11.5	24	502386-0707	502386-0771		7
25.5	11.5	24	502386-0607	502386-0671		6
25.5	11.5	24	502386-0507	502386-0571	5	
25.5	11.5	24	502386-0407	502386-0471	4	
17.5	7.5	16	502386-0307	502386-0371	3	
17.5	7.5	16	502386-0207	502386-0271	2	
C	B	エンボステープ幅 A WIDTH OF TAPE	コネクタ CONNECTOR	製品番号 MATERIAL NO.	モデル番号 MODEL NO.	極数 (KT. NO.)

REVISED EC NO: J2016-0012 DRWN: TAKAIKE 2015/07/24 CHKD: KASAKAWA 2015/07/27 APPR: NUKITA 2015/07/27	GENERAL TOLERANCES (UNLESS SPECIFIED)			DIMENSION STYLE MM ONLY		SCALE	DESIGN UNITS METRIC	THIRD ANGLE PROJECTION
	0.25 UNDER	UNDER	±0.03	DRAWN BY Y. AOYAGI	DATE 2008/10/17	TITLE 1.25 W/B CONN. SINGLE R/A REC. EMBTP PKG		
	0.25 OVER	0.5 UNDER	±0.05	CHECKED BY T. HARUYAMA	DATE 2008/10/17			
	0.5 OVER	1.0 UNDER	±0.1	APPROVED BY N. UKITA	DATE 2008/10/17			
	1.0 OVER	10 UNDER	±0.2	MATERIAL NO.		DOCUMENT NO. SD-502386-005	SHEET NO. 1 OF 1	
10 OVER	30 UNDER	±0.25	SEE TABLE		THIS DRAWING CONTAINS INFORMATION THAT IS PROPRIETARY TO MOLEX INCORPORATED AND SHOULD NOT BE USED WITHOUT WRITTEN PERMISSION			
30 OVER		±0.3	DRAFT WHERE APPLICABLE MUST REMAIN WITHIN DIMENSIONS					

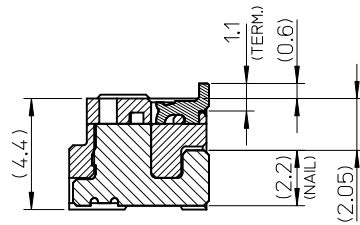
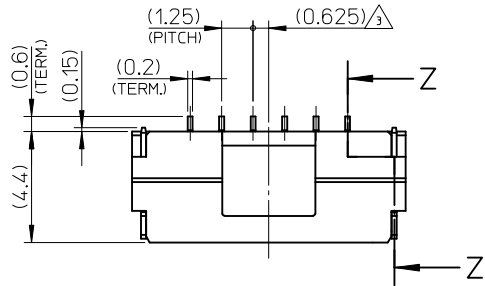

SECTION Z-Z

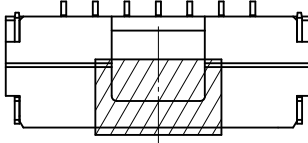

カプトンテープ付き
WITH KAPTON TAPE

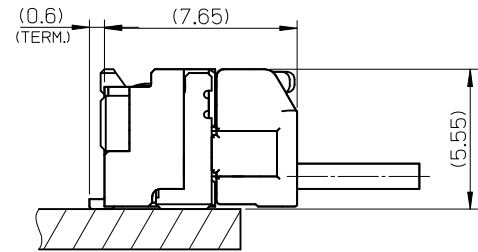
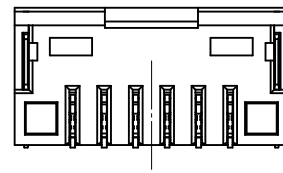
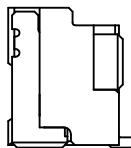
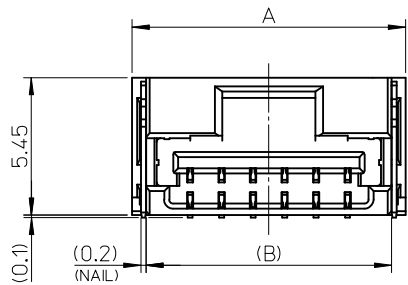
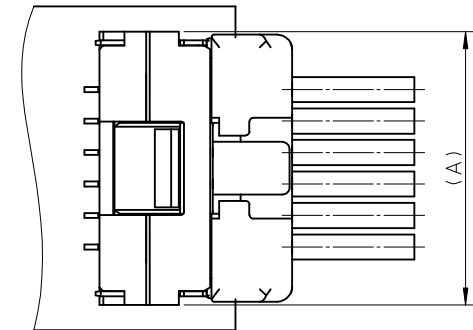

嵌合図

MATED CONNECTORS

NOTES

- 嵌合相手: 502380-****
MATE WITH : 502380-****
- 端子テール部 及び ネイルの平坦度: 0.1MAX.
TAIL AND NAIL COPLANARITY TO BE 0.1 MAX.
- 極数/2=偶数に適用。
APPLY FOR CKT. SIZE / 2 = EVEN.
- 端子テール部 及び ネイルに錫めっきを使用しているため、
外観に摺動痕が付く場合が御座います。
THE WOUND OF FRICTION MIGHT ADHERE TO EXTERNALS
BECAUSE THE TIN PLATING IS USED FOR THA TAIL AND NAIL.
- 本製品のプラスチック部に黒点等が確認される場合や
色合いが異なる場合がありますが、製品性能に影響はありません。
THERE IS NO INFLUENCE IN THE PRODUCT PERFORMANCE THOUGH
THE BLACK SPOT ETC. MIGHT BE CONFIRMED TO THE PLASTIC PART
OF THIS PRODUCT AND THE SHADE MIGHT BE DIFFERENT.
- ELV 及び RoHS 適合品
ELV AND RoHS COMPLIANT

3.4	7.5	11	12.1	502386-0707	7
3.4	6.25	9.75	10.85	502386-0607	6
3.4	5	8.5	9.6	502386-0507	5
3.4	3.75	7.25	8.35	502386-0407	4
2.6	2.5	6	7.1	502386-0307	3
2.2	1.25	4.75	5.85	502386-0207	2
D	C	B	A	EMBOSSED TAPE PACKAGE オーダー番号 ORDER No.	極数 CKT. NO.

番号 NO.	部品 PART	材質 MATERIAL
①	ハウジング HOUSING	耐熱性樹脂 UL94V-0 色: ナチュラル HEATPROOF RESIN UL94V-0 COLOR : NATURAL
②	ターミナル TERMINAL	銅合金 COPPER ALLOY 金めっき : 0.1 micro-meter MIN. GOLD ニッケルめっき(下地): 1.0 micro-meter MIN. NICKEL (UNDER PLATING)
③	ネイル NAIL	銅合金 COPPER ALLOY 錫めっき: 1.0 micro-meter MIN. TIN ニッケルめっき(下地): 1.0 micro-meter MIN. NICKEL (UNDER PLATING)

RELEASED EC NO.: J2016-0012 DRWN: TAKAIKE 2015/07/23 CHKD: KASAKAWA 2015/07/21 APPR: NUKITA 2015/07/21	GENERAL TOLERANCES (UNLESS SPECIFIED)		DIMENSION STYLE MM ONLY		SCALE	DESIGN UNITS	TITLE 1.25 W/B CONN. SINGLE R/A REC. ASS'Y 2-7CKT. molex DOCUMENT NO. SD-502386-006 SHEET NO. 1 OF 2
	0.25 UNDER	UNDER	±0.03	DRAWN BY	DATE	TITLE	
	0.25 OVER	0.5 UNDER	±0.05	TAKAIKE	2015/02/23		
	0.5 OVER	1.0 UNDER	±0.1	CHECKED BY	DATE		
1.0 OVER	10 UNDER	±0.2	KASAKAWA	2015/07/21			
10 OVER	30 UNDER	±0.25	APPROVED BY	DATE			
30 OVER		±0.3	NUKITA	2015/07/21			
ANGULAR	±3 °		MATERIAL NO.				
DRAFT WHERE APPLICABLE MUST REMAIN WITHIN DIMENSIONS			SIZE	THIS DRAWING CONTAINS INFORMATION THAT IS PROPRIETARY TO MOLEX INCORPORATED AND SHOULD NOT BE USED WITHOUT WRITTEN PERMISSION			



2 CKT.



3 CKT.



4 CKT.

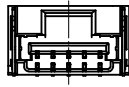
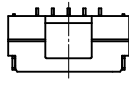

5 CKT.

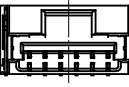
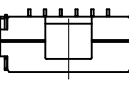

6 CKT.

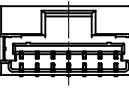
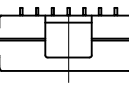

7 CKT.

極数の種類

KIND OF CKT. NO.(FRONT VIEW)

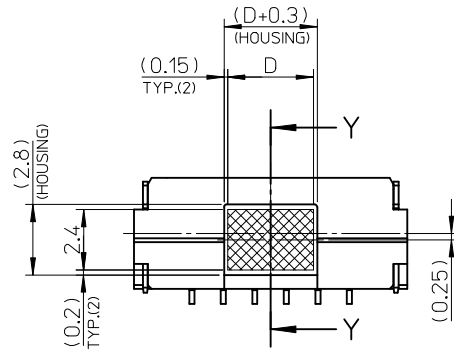

吸着範囲
VACUME AREA

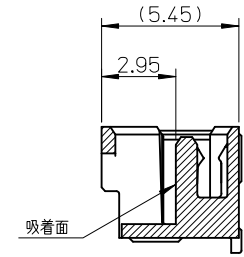

SECTION Y-Y

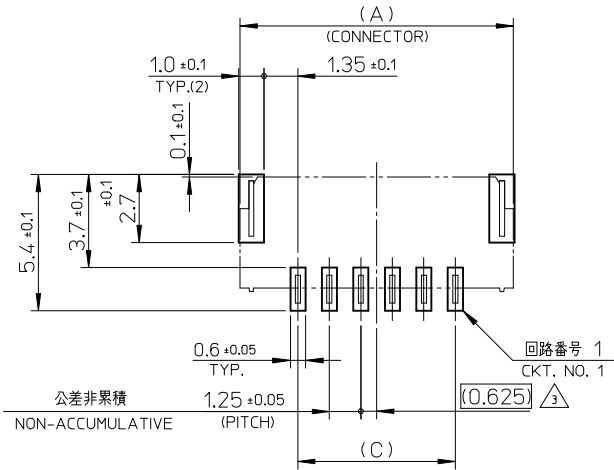

公差非累積
NON-ACCUMULATIVE

基板パターンレイアウト (参考)

RECCOMENDED P.C.B. PATTERN LAYOUT (REF.)

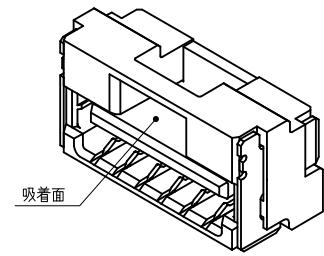

RELEASED EC NO.: J2016-0012 DRWN: TAKAIKE 2015/02/23 CHK'D: KASAKAWA 2015/07/21 APPR: NUKITA 2015/07/21 A	GENERAL TOLERANCES (UNLESS SPECIFIED)			DIMENSION STYLE MM ONLY		SCALE	DESIGN UNITS METRIC	THIRD ANGLE PROJECTION
	0.25 UNDER	UNDER	± 0.03	DRAWN BY	DATE	TITLE	1.25 W/B CONN. SINGLE R/A REC. ASS'Y 2-7CKT.	
	0.25 OVER	0.5 UNDER	± 0.05	TAKAIKE	2015/02/23			
	0.5 OVER	1.0 UNDER	± 0.1	CHECKED BY	DATE			
	1.0 OVER	10 UNDER	± 0.2	KASAKAWA	2015/07/21			
10 OVER	30 UNDER	± 0.25	APPROVED BY	DATE				
30 OVER		± 0.3	NUKITA	2015/07/21				
ANGULAR	± 3 °		MATERIAL NO.		DOCUMENT NO.		SHEET NO.	
DRAFT WHERE APPLICABLE MUST REMAIN WITHIN DIMENSIONS			SEE TABLE		SD-502386-006		2 OF 2	
			THIS DRAWING CONTAINS INFORMATION THAT IS PROPRIETARY TO MOLEX INCORPORATED AND SHOULD NOT BE USED WITHOUT WRITTEN PERMISSION					