

FEATURES

- Programmable Differential Gain via Two External Resistors
- Adjustable Output Common Mode Voltage
- Operates and Specified with 3V, 5V, ±5V Supplies
- 0.5dB Ripple 4th Order Lowpass Filter with 10MHz Cutoff
- 82dB S/N with 3V Supply and 2V_{P-P} Output
- Low Distortion, 2V_{P-P}, 800Ω Load
 - 1MHz: 88dBc 2nd, 97dBc 3rd
 - 5MHz: 74dBc 2nd, 77dBc 3rd
- Fully Differential Inputs and Outputs
- Compatible with Popular Differential Amplifier Pinouts
- SO-8 and DFN-12 Packages

APPLICATIONS

- High Speed ADC Antialiasing and DAC Smoothing in Networking or Cellular Base Station Applications
- High Speed Test and Measurement Equipment
- Medical Imaging
- Drop-In Replacement for Differential Amplifiers

LT, LT, LTC, LTM, Linear Technology and the Linear logo are registered trademarks of Linear Technology Corporation. All other trademarks are the property of their respective owners.

DESCRIPTION

The LT[®]6600-10 combines a fully differential amplifier with a 4th order 10MHz lowpass filter approximating a Chebyshev frequency response. Most differential amplifiers require many precision external components to tailor gain and bandwidth. In contrast, with the LT6600-10, two external resistors program differential gain, and the filter's 10MHz cutoff frequency and passband ripple are internally set. The LT6600-10 also provides the necessary level shifting to set its output common mode voltage to accommodate the reference voltage requirements of A/Ds.

Using a proprietary internal architecture, the LT6600-10 integrates an antialiasing filter and a differential amplifier/driver without compromising distortion or low noise performance. At unity gain the measured in band signal-to-noise ratio is an impressive 82dB. At higher gains the input referred noise decreases so the part can process smaller input differential signals without significantly degrading the output signal-to-noise ratio.

The LT6600-10 also features low voltage operation. The differential design provides outstanding performance for a 2V_{P-P} signal level while the part operates with a single 3V supply.

For similar devices with other cutoff frequencies, refer to the LT6600-20, LT6600-15, LT6600-5 and LT6600-2.5.

TYPICAL APPLICATION (S8 pin numbers shown)

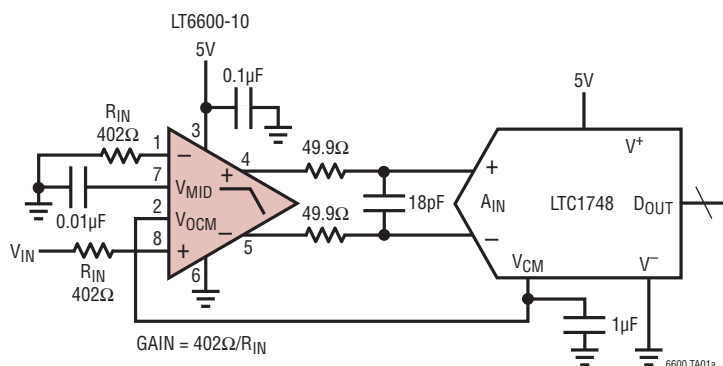

An 8192 Point FFT Spectrum

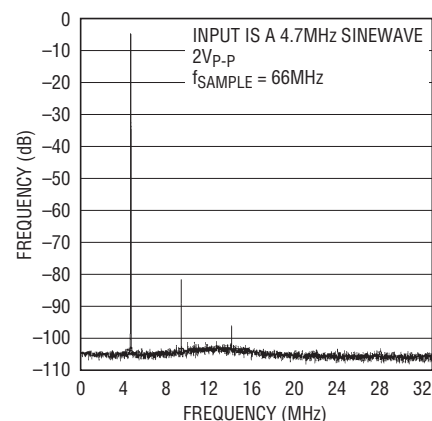

ABSOLUTE MAXIMUM RATINGS (Note 1)

Total Supply Voltage	11V	Junction Temperature	150°C
Input Current (Note 8).....	±10mA	Storage Temperature Range.....	-65°C to 150°C
Operating Temperature Range (Note 6)....	-40°C to 85°C	Lead Temperature (Soldering, 10 sec)	300°C
Specified Temperature Range (Note 7)	-40°C to 85°C		

PIN CONFIGURATION

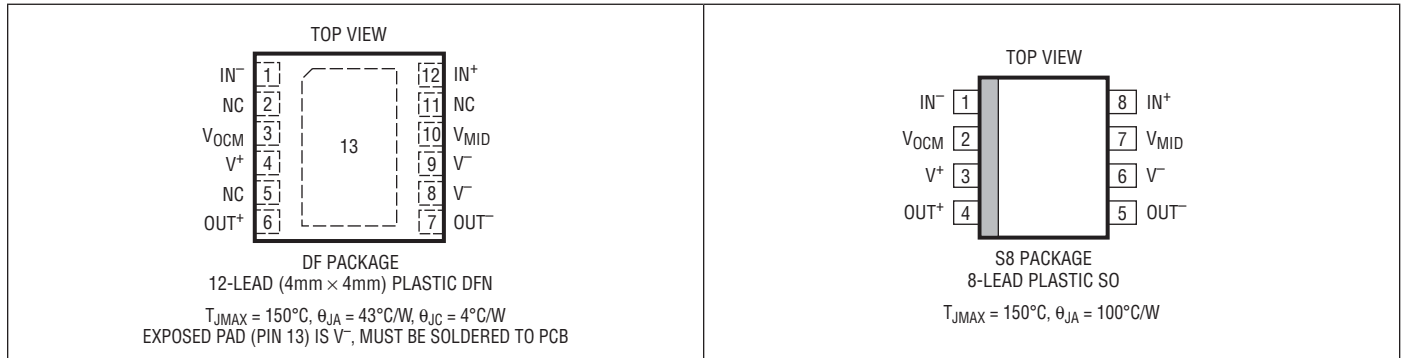

ORDER INFORMATION

LEAD FREE FINISH	TAPE AND REEL	PART MARKING	PACKAGE DESCRIPTION	TEMPERATURE RANGE
LT6600CS8-10#PBF	LT6600CS8-10#TRPBF	660010	8-Lead Plastic SO	0°C to 70°C
LT6600IS8-10#PBF	LT6600IS8-10#TRPBF	600I10	8-Lead Plastic SO	-40°C to 85°C
LT6600CDF-10#PBF	LT6600CDF-10#TRPBF	60010	12-Lead (4mm × 4mm) Plastic DFN	0°C to 70°C
LT6600IDF-10#PBF	LT6600IDF-10#TRPBF	60010	12-Lead (4mm × 4mm) Plastic DFN	-40°C to 85°C
LEAD BASED FINISH	TAPE AND REEL	PART MARKING	PACKAGE DESCRIPTION	TEMPERATURE RANGE
LT6600CS8-10	LT6600CS8#TR	660010	8-Lead Plastic SO	0°C to 70°C
LT6600IS8-10	LT6600IS8-10#TR	600I10	8-Lead Plastic SO	-40°C to 85°C

Consult LTC Marketing for parts specified with wider operating temperature ranges. Consult LTC Marketing for information on non-standard lead based finish parts. The temperature grade is identified by a label on the shipping container for the DFN Package.

For more information on lead free part marking, go to: <http://www.linear.com/leadfree/>

For more information on tape and reel specifications, go to: <http://www.linear.com/tapeandreel/>

ELECTRICAL CHARACTERISTICS The ● denotes the specifications which apply over the full operating temperature range, otherwise specifications are at $T_A = 25^\circ\text{C}$. Unless otherwise specified $V_S = 5\text{V}$ ($V^+ = 5\text{V}$, $V^- = 0\text{V}$), $R_{IN} = 402\Omega$, and $R_{LOAD} = 1\text{k}$.

PARAMETER	CONDITIONS		MIN	TYP	MAX	UNITS
Filter Gain, $V_S = 3\text{V}$	$V_{IN} = 2V_{P-P}$, $f_{IN} = \text{DC to } 260\text{kHz}$		-0.4	0	0.5	dB
		$V_{IN} = 2V_{P-P}$, $f_{IN} = 1\text{MHz}$ (Gain Relative to 260kHz)	● -0.1	0	0.1	dB
		$V_{IN} = 2V_{P-P}$, $f_{IN} = 5\text{MHz}$ (Gain Relative to 260kHz)	● -0.4	-0.1	0.3	dB
		$V_{IN} = 2V_{P-P}$, $f_{IN} = 8\text{MHz}$ (Gain Relative to 260kHz)	● -0.3	0.1	1	dB
		$V_{IN} = 2V_{P-P}$, $f_{IN} = 10\text{MHz}$ (Gain Relative to 260kHz)	● -0.2	0.3	1.7	dB
		$V_{IN} = 2V_{P-P}$, $f_{IN} = 30\text{MHz}$ (Gain Relative to 260kHz)	●	-28	-25	dB
		$V_{IN} = 2V_{P-P}$, $f_{IN} = 50\text{MHz}$ (Gain Relative to 260kHz)	●	-44		dB
Filter Gain, $V_S = 5\text{V}$	$V_{IN} = 2V_{P-P}$, $f_{IN} = \text{DC to } 260\text{kHz}$		-0.5	0	0.5	dB
		$V_{IN} = 2V_{P-P}$, $f_{IN} = 1\text{MHz}$ (Gain Relative to 260kHz)	● -0.1	0	0.1	dB
		$V_{IN} = 2V_{P-P}$, $f_{IN} = 5\text{MHz}$ (Gain Relative to 260kHz)	● -0.4	-0.1	0.3	dB
		$V_{IN} = 2V_{P-P}$, $f_{IN} = 8\text{MHz}$ (Gain Relative to 260kHz)	● -0.4	0.1	0.9	dB
		$V_{IN} = 2V_{P-P}$, $f_{IN} = 10\text{MHz}$ (Gain Relative to 260kHz)	● -0.3	0.2	1.4	dB
		$V_{IN} = 2V_{P-P}$, $f_{IN} = 30\text{MHz}$ (Gain Relative to 260kHz)	●	-28	-25	dB
		$V_{IN} = 2V_{P-P}$, $f_{IN} = 50\text{MHz}$ (Gain Relative to 260kHz)	●	-44		dB
Filter Gain, $V_S = \pm 5\text{V}$	$V_{IN} = 2V_{P-P}$, $f_{IN} = \text{DC to } 260\text{kHz}$		-0.6	-0.1	0.4	dB
Filter Gain, $R_{IN} = 100\Omega$, $V_S = 3\text{V}, 5\text{V}, \pm 5\text{V}$	$V_{IN} = 0.5V_{P-P}$, $f_{IN} = \text{DC to } 260\text{kHz}$		11.4	12	12.6	dB
Filter Gain Temperature Coefficient (Note 2)	$f_{IN} = 260\text{kHz}$, $V_{IN} = 2V_{P-P}$			780		ppm/C
Noise	Noise BW = 10kHz to 10MHz, $R_{IN} = 402\Omega$			56		μV_{RMS}
Distortion (Note 4)	1MHz, $2V_{P-P}$, $R_L = 800\Omega$	2nd Harmonic		88		dBc
		3rd Harmonic		97		dBc
	5MHz, $2V_{P-P}$, $R_L = 800\Omega$	2nd Harmonic		74		dBc
		3rd Harmonic		77		dBc
Differential Output Swing	Measured Between Pins 4 and 5 Pin 7 Shorted to Pin 2	$V_S = 5\text{V}$	● 3.85	5.0		$V_{P-P \text{ DIFF}}$
		$V_S = 3\text{V}$	● 3.85	4.9		$V_{P-P \text{ DIFF}}$
Input Bias Current	Average of Pin 1 and Pin 8		● -85	-40		μA
Input Referred Differential Offset	$R_{IN} = 402\Omega$	$V_S = 3\text{V}$	●	5	20	mV
		$V_S = 5\text{V}$	●	10	30	mV
		$V_S = \pm 5\text{V}$	●	8	35	mV
	$R_{IN} = 100\Omega$	$V_S = 3\text{V}$	●	5	13	mV
		$V_S = 5\text{V}$	●	5	22	mV
		$V_S = \pm 5\text{V}$	●	5	30	mV
Differential Offset Drift				10		$\mu\text{V}/^\circ\text{C}$

ELECTRICAL CHARACTERISTICS

The ● denotes the specifications which apply over the full operating temperature range, otherwise specifications are at $T_A = 25^\circ\text{C}$. Unless otherwise specified $V_S = 5\text{V}$ ($V^+ = 5\text{V}$, $V^- = 0\text{V}$), $R_{IN} = 402\Omega$, and $R_{LOAD} = 1\text{k}$.

PARAMETER	CONDITIONS	MIN	TYP	MAX	UNITS	
Input Common Mode Voltage (Note 3)	Differential Input = $500\text{mV}_{\text{P-P}}$, $R_{IN} = 100\Omega$	$V_S = 3\text{V}$ ●	0.0	1.5	V	
		$V_S = 5\text{V}$ ●	0.0	3.0	V	
		$V_S = \pm 5\text{V}$ ●	-2.5	1.0	V	
Output Common Mode Voltage (Note 5)	Differential Input = $2\text{V}_{\text{P-P}}$, Pin 7 = OPEN	$V_S = 3\text{V}$ ●	1.0	1.5	V	
		$V_S = 5\text{V}$ ●	1.5	3.0	V	
		$V_S = \pm 5\text{V}$ ●	-1.0	2.0	V	
Output Common Mode Offset (With Respect to Pin 2)		$V_S = 3\text{V}$ ●	-35	5	40	mV
		$V_S = 5\text{V}$ ●	-40	0	40	mV
		$V_S = \pm 5\text{V}$ ●	-55	-5	35	mV
Common Mode Rejection Ratio			61		dB	
Voltage at V_{MID} (Pin 7)	$V_S = 5\text{V}$ (S8) ● $V_S = 5\text{V}$ (DFN) ● $V_S = 3\text{V}$ ●	2.46	2.51	2.55	V	
		2.45	2.51	2.56	V	
			1.5		V	
V_{MID} Input Resistance		4.3	5.5	7.7	k Ω	
V_{OCM} Bias Current	$V_{\text{OCM}} = V_{\text{MID}} = V_S/2$	$V_S = 5\text{V}$ ●	-15	-3	μA	
		$V_S = 3\text{V}$ ●	-10	-3	μA	
Power Supply Current	$V_S = 3\text{V}$, $V_S = 5\text{V}$ ● $V_S = 3\text{V}$, $V_S = 3\text{V}$ ● $V_S = \pm 5\text{V}$ ●		35	39	mA	
				43	mA	
			36	46	mA	

Note 1: Stresses beyond those listed under Absolute Maximum Ratings may cause permanent damage to the device. Exposure to any Absolute Maximum Rating condition for extended periods may affect device reliability and lifetime.

Note 2: This is the temperature coefficient of the internal feedback resistors assuming a temperature independent external resistor (R_{IN}).

Note 3: The input common mode voltage is the average of the voltages applied to the external resistors (R_{IN}). Specification guaranteed for $R_{IN} \geq 100\Omega$.

Note 4: Distortion is measured differentially using a differential stimulus. The input common mode voltage, the voltage at V_{OCM} , and the voltage at V_{MID} are equal to one half of the total power supply voltage.

Note 5: Output common mode voltage is the average of the voltages at Pins 4 and 5. The output common mode voltage is equal to the voltage applied to V_{OCM} .

Note 6: The LT6600C is guaranteed functional over the operating temperature range -40°C to 85°C .

Note 7: The LT6600C is guaranteed to meet 0°C to 70°C specifications and is designed, characterized and expected to meet the extended temperature limits, but is not tested at -40°C and 85°C . The LT6600I is guaranteed to meet specified performance from -40°C to 85°C .

Note 8: The inputs are protected by back-to-back diodes. If the differential input voltage exceeds 1.4V, the input current should be limited to less than 10mA.

TYPICAL PERFORMANCE CHARACTERISTICS

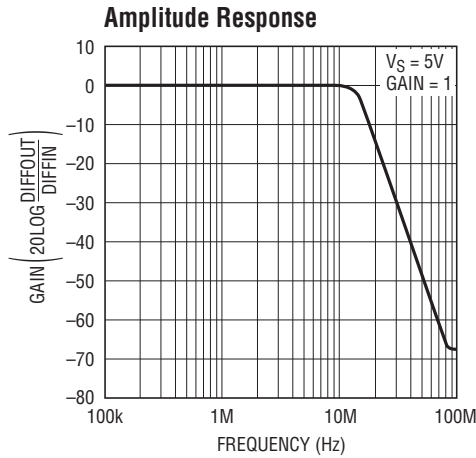

6600 G01

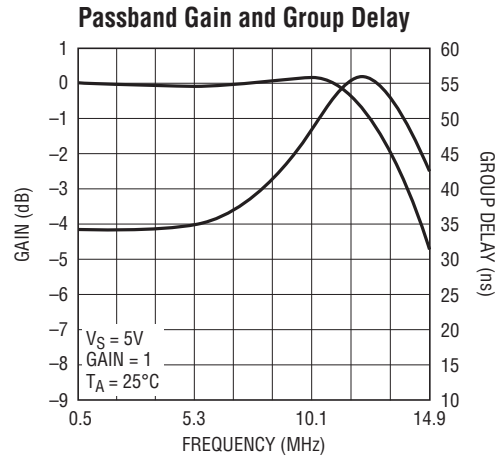

6600 G02

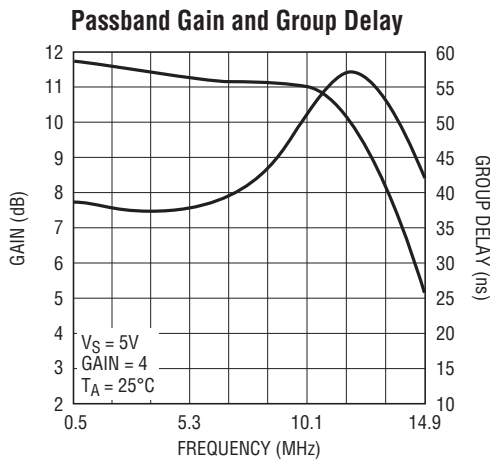

6600 G03

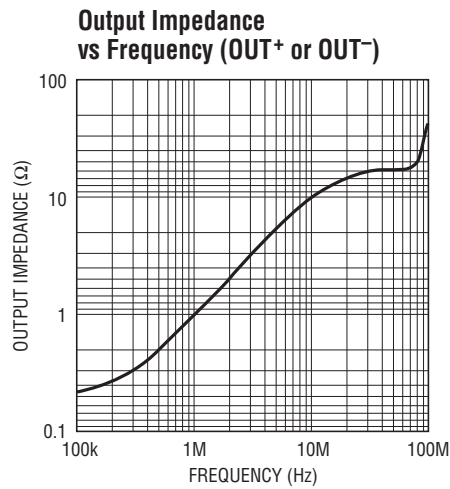

6600 G04

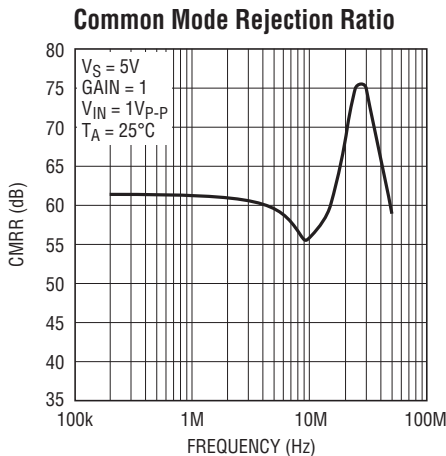

6600 G05

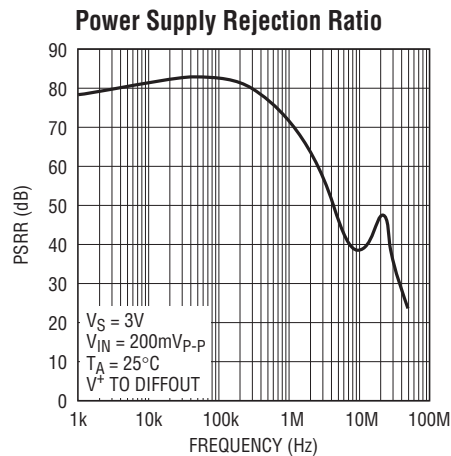

6600 G06

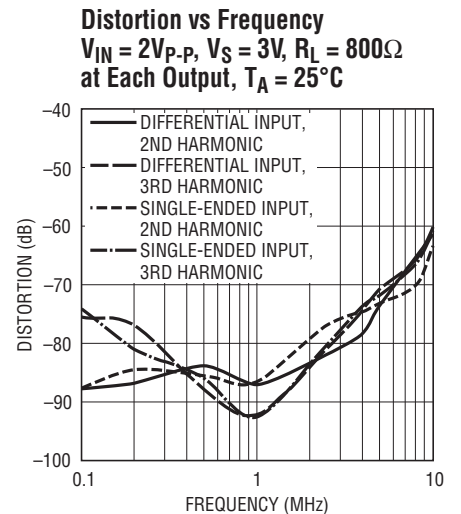

6600 G07

TYPICAL PERFORMANCE CHARACTERISTICS

Distortion vs Frequency

$V_{IN} = 2V_{p-p}$, $V_S = \pm 5V$, $R_L = 800\Omega$ at Each Output, $T_A = 25^\circ C$

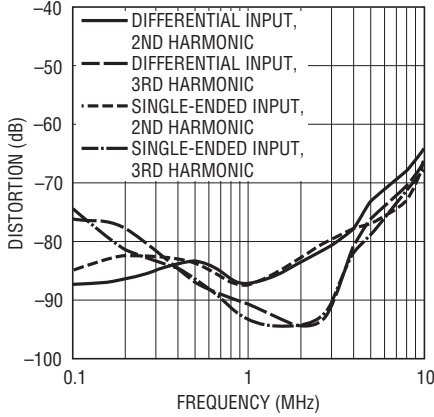

Distortion vs Signal Level

$V_S = 3V$, $R_L = 800\Omega$ at Each Output, $T_A = 25^\circ C$

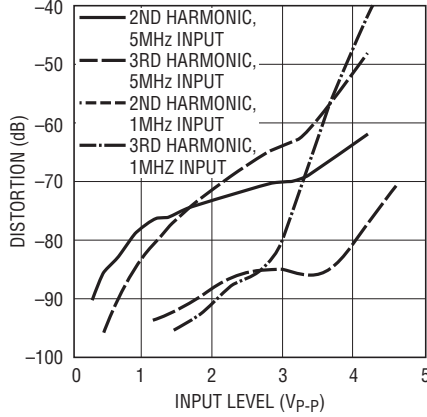

Distortion vs Signal Level

$V_S = \pm 5V$, $R_L = 800\Omega$ at Each Output, $T_A = 25^\circ C$

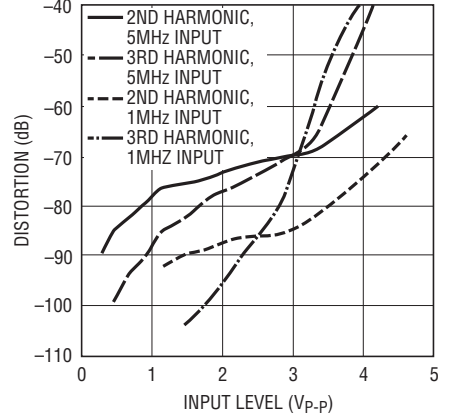

Distortion vs Input Common Mode Level, $2V_{p-p}$, 1MHz Input, 1x Gain, $R_L = 800\Omega$ at Each Output, $T_A = 25^\circ C$

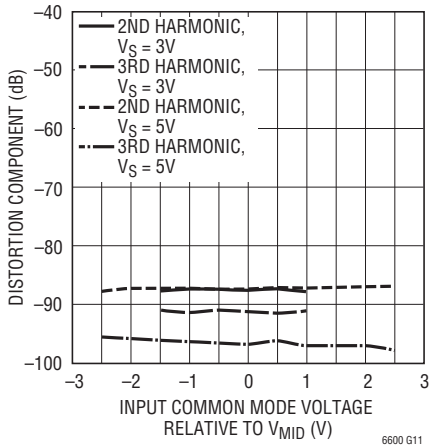

Distortion vs Input Common Mode Level, $0.5V_{p-p}$, 1MHz Input, 4x Gain, $R_L = 800\Omega$ at Each Output, $T_A = 25^\circ C$

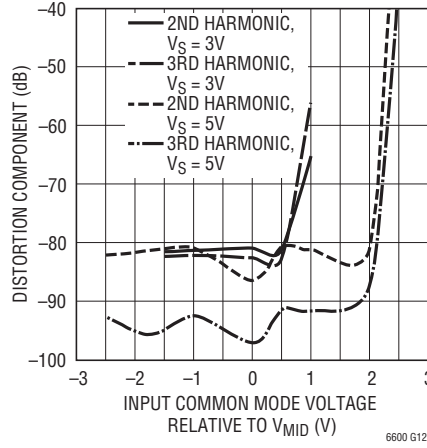

Power Supply Current vs Power Supply Voltage

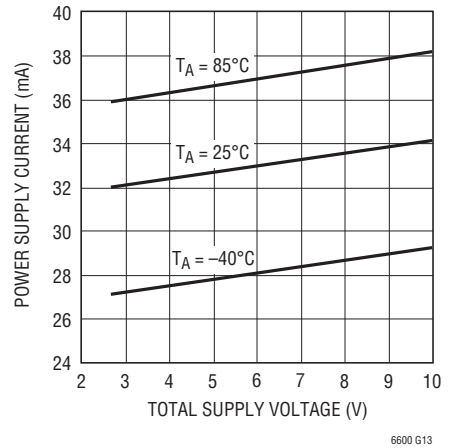

Transient Response, Differential Gain = 1

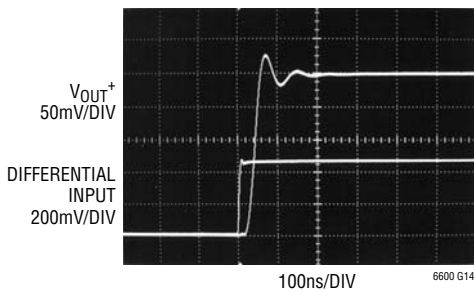

Distortion vs Output Common Mode, $2V_{p-p}$ 1MHz Input, 1x Gain, $T_A = 25^\circ C$

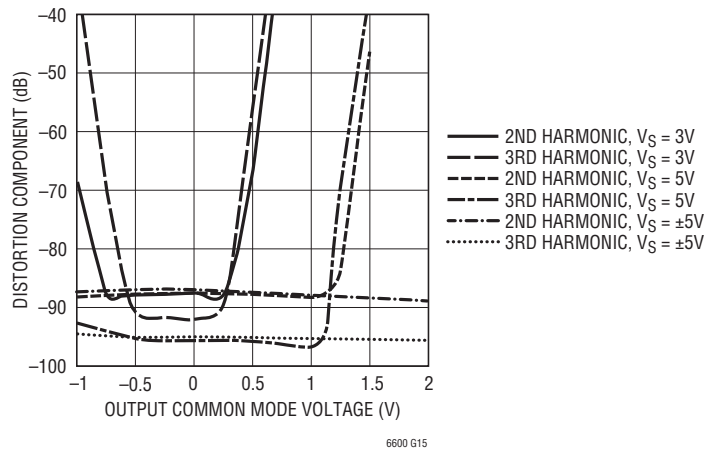

PIN FUNCTIONS (DFN/S8)

IN⁻ and IN⁺ (Pins 1, 12/Pins 1, 8): Input Pins. Signals can be applied to either or both input pins through identical external resistors, R_{IN}. The DC gain from differential inputs to the differential outputs is 1580Ω/R_{IN}.

NC (Pin 2, 5, 11/NA): No Connection.

V_{OCM} (Pin 3/Pin 2): Is the DC Common Mode Reference Voltage for the 2nd Filter Stage. Its value programs the common mode voltage of the differential output of the filter. This is a high impedance input, which can be driven from an external voltage reference, or can be tied to V_{MID} on the PC board. V_{OCM} should be bypassed with a 0.01μF ceramic capacitor unless it is connected to a ground plane.

V⁺ and V⁻ (Pins 4, 8, 9/Pins 3, 6): Power Supply Pins. For a single 3.3V or 5V supply (V⁻ grounded) a quality 0.1μF ceramic bypass capacitor is required from the positive supply pin (V⁺) to the negative supply pin (V⁻). The bypass

should be as close as possible to the IC. For dual supply applications, bypass V⁺ to ground and V⁻ to ground with a quality 0.1μF ceramic capacitor.

OUT⁺ and OUT⁻ (Pins 6, 7/Pins 4, 5): Output Pins. These are the filter differential outputs. Each pin can drive a 100Ω and/or 50pF load to AC ground.

V_{MID} (Pin 10/Pin 7): The V_{MID} pin is internally biased at mid-supply, see block diagram. For single-supply operation the V_{MID} pin should be bypassed with a quality 0.01μF ceramic capacitor to V⁻. For dual supply operation, V_{MID} can be bypassed or connected to a high quality DC ground. A ground plane should be used. A poor ground will increase noise and distortion. V_{MID} sets the output common mode voltage of the 1st stage of the filter. It has a 5.5kΩ impedance, and it can be overridden with an external low impedance voltage source.

BLOCK DIAGRAM

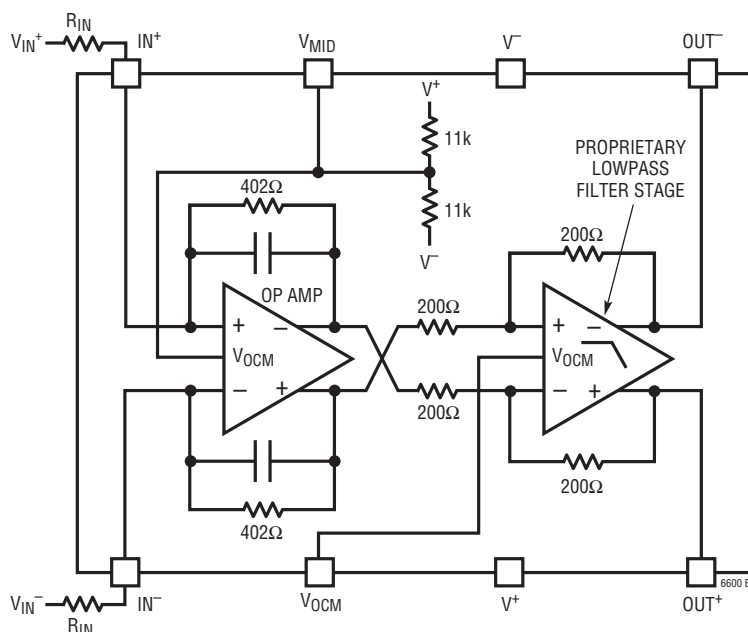

APPLICATIONS INFORMATION

Interfacing to the LT6600-10

Note: The referenced pin numbers correspond to the S8 package. See the Pin Functions section for the equivalent DFN-12 package pin numbers.

The LT6600-10 requires 2 equal external resistors, R_{IN} , to set the differential gain to $402\Omega/R_{IN}$. The inputs to the filter are the voltages V_{IN}^+ and V_{IN}^- presented to these external components, Figure 1. The difference between V_{IN}^+ and V_{IN}^- is the differential input voltage. The average of V_{IN}^+ and V_{IN}^- is the common mode input voltage. Similarly, the voltages V_{OUT}^+ and V_{OUT}^- appearing at Pins 4 and 5 of the LT6600-10 are the filter outputs. The difference between V_{OUT}^+ and V_{OUT}^- is the differential output voltage. The average of V_{OUT}^+ and V_{OUT}^- is the common mode output voltage.

Figure 1 illustrates the LT6600-10 operating with a single 3.3V supply and unity passband gain; the input signal is DC coupled. The common mode input voltage is 0.5V and the differential input voltage is $2V_{P-P}$. The common mode output voltage is 1.65V and the differential output voltage is $2V_{P-P}$ for frequencies below 10MHz. The common mode output voltage is determined by the voltage at V_{OCM} . Since V_{OCM} is shorted to V_{MID} the output common mode is the mid-supply voltage. In addition, the common mode input voltage can be equal to the mid-supply voltage of V_{MID} (refer to the Distortion vs Input Common Mode Level graphs in the Typical Performance Characteristics section).

Figure 2 shows how to AC couple signals into the LT6600-10. In this instance, the input is a single-ended signal. AC-coupling allows the processing of single-ended or differential signals with arbitrary common mode levels. The 0.1 μ F coupling capacitor and the 402 Ω gain setting resistor form a high pass filter, attenuating signals below 4kHz. Larger values of coupling capacitors will proportionally reduce this highpass 3dB frequency.

In Figure 3 the LT6600-10 is providing 12dB of gain. The gain resistor has an optional 62pF in parallel to improve the passband flatness near 10MHz. The common mode output voltage is set to 2V.

Use Figure 4 to determine the interface between the LT6600-10 and a current output DAC. The gain, or “transimpedance”, is defined as $A = V_{OUT}/I_{IN}\Omega$. To compute the transimpedance, use the following equation:

$$A = \frac{402 \cdot R1}{R1 + R2} \Omega$$

By setting $R1 + R2 = 402\Omega$, the gain equation reduces to $A = R1\Omega$.

The voltage at the pins of the DAC is determined by $R1$, $R2$, the voltage on V_{MID} and the DAC output current (I_{IN}^+ or I_{IN}^-). Consider Figure 4 with $R1 = 49.9\Omega$ and $R2 = 348\Omega$. The voltage at V_{MID} is 1.65V. The voltage at the DAC pins is given by:

$$\begin{aligned} V_{DAC} &= V_{PIN7} \cdot \frac{R1}{R1 + R2 + 402} + I_{IN} \frac{R1 \cdot R2}{R1 + R2} \\ &= 103mV + I_{IN} 43.6\Omega \end{aligned}$$

I_{IN} is I_{IN}^- or I_{IN}^+ . The transimpedance in this example is 50.4 Ω .

Evaluating the LT6600-10

The low impedance levels and high frequency operation of the LT6600-10 require some attention to the matching networks between the LT6600-10 and other devices. The previous examples assume an ideal (0 Ω) source impedance and a large (1k Ω) load resistance. Among practical examples where impedance must be considered is the evaluation of the LT6600-10 with a network analyzer. Figure 5 is a laboratory setup that can be used to characterize the LT6600-10 using single-ended instruments with 50 Ω source impedance and 50 Ω input impedance. For a unity gain configuration the LT6600-10 requires a 402 Ω source resistance yet the network analyzer output is calibrated for a 50 Ω load resistance. The 1:1 transformer, 53.6 Ω and 388 Ω resistors satisfy the two constraints above. The transformer converts the single-ended source into a differential stimulus. Similarly, the output the LT6600-10 will have lower distortion with larger load resistance yet the analyzer input is typically 50 Ω . The 4:1 turns (16:1 impedance) transformer and the two 402 Ω resistors of

APPLICATIONS INFORMATION

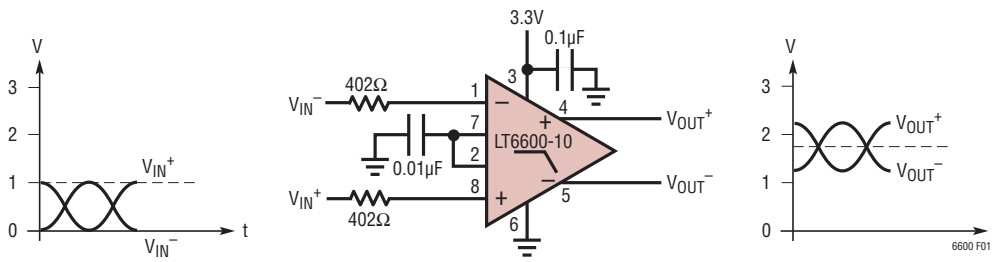

Figure 1. (S8 Pin Numbers)

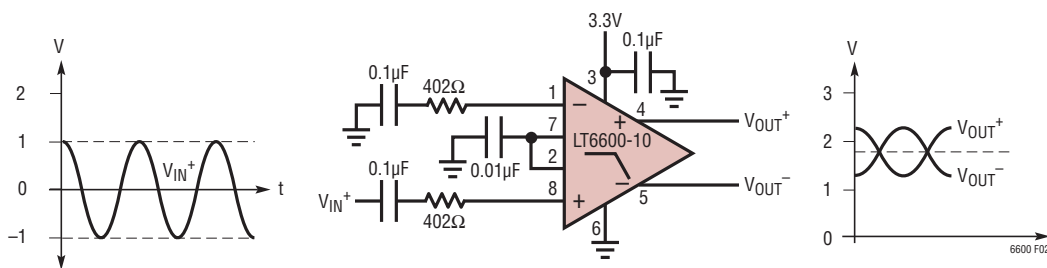

Figure 2. (S8 Pin Numbers)

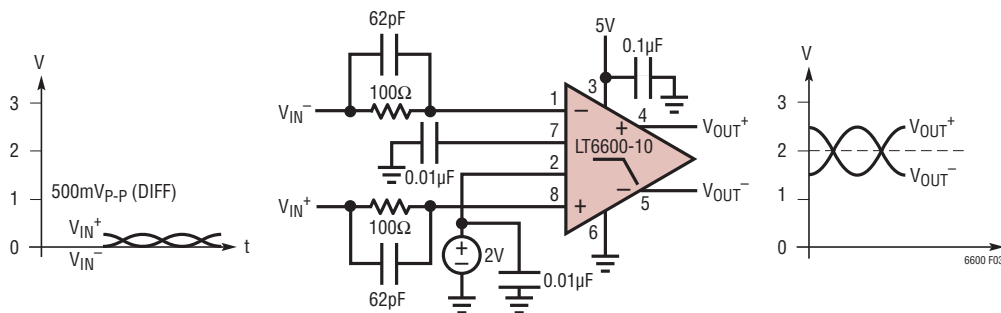

Figure 3. (S8 Pin Numbers)

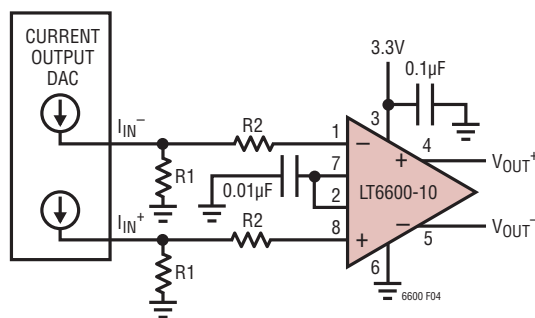

Figure 4. (S8 Pin Numbers)

APPLICATIONS INFORMATION

Figure 5, present the output of the LT6600-10 with a 1600Ω differential load, or the equivalent of 800Ω to ground at each output. The impedance seen by the network analyzer input is still 50Ω, reducing reflections in the cabling between the transformer and analyzer input.

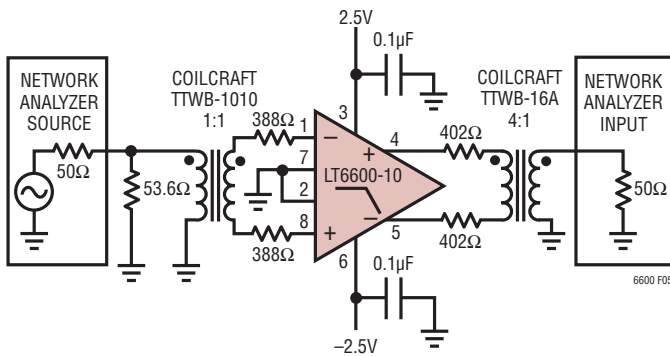

Figure 5. (S8 Pin Numbers)

Differential and Common Mode Voltage Ranges

The differential amplifiers inside the LT6600-10 contain circuitry to limit the maximum peak-to-peak differential voltage through the filter. This limiting function prevents excessive power dissipation in the internal circuitry and provides output short-circuit protection. The limiting function begins to take effect at output signal levels above 2V_{P-P} and it becomes noticeable above 3.5V_{P-P}. This is illustrated in Figure 6; the LTC6600-10 was configured with unity passband gain and the input of the filter was driven with a 1MHz signal. Because this voltage limiting takes place well before the output stage of the filter reaches the supply rails, the input/output behavior of the IC shown in Figure 6 is relatively independent of the power supply voltage.

The two amplifiers inside the LT6600-10 have independent control of their output common mode voltage (see the Block Diagram section). The following guidelines will optimize the performance of the filter for single-supply operation.

V_{MID} must be bypassed to an AC ground with a 0.01µF or higher capacitor. V_{MID} can be driven from a low impedance source, provided it remains at least 1.5V above V⁻ and at least 1.5V below V⁺. An internal resistor divider sets the

voltage of V_{MID}. While the internal 11k resistors are well matched, their absolute value can vary by ±20%. This should be taken into consideration when connecting an external resistor network to alter the voltage of V_{MID}.

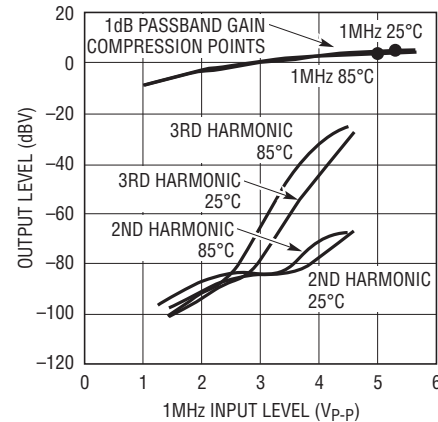

Figure 6

V_{OCM} can be shorted to V_{MID} for simplicity. If a different common mode output voltage is required, connect V_{OCM} to a voltage source or resistor network. For 3V and 3.3V supplies the voltage at V_{OCM} must be less than or equal to the mid-supply level. For example, voltage (V_{OCM}) ≤ 1.65V on a single 3.3V supply. For power supply voltages higher than 3.3V the voltage at V_{OCM} can be set above mid-supply. The voltage on V_{OCM} should not be more than 1V below the voltage on V_{MID}. The voltage on V_{OCM} should not be more than 2V above the voltage on V_{MID}. V_{OCM} is a high impedance input.

The LT6600-10 was designed to process a variety of input signals including signals centered around the mid-supply voltage and signals that swing between ground and a positive voltage in a single-supply system (Figure 1). The range of allowable input common mode voltage (the average of V_{IN}⁺ and V_{IN}⁻ in Figure 1) is determined by the power supply level and gain setting (see the Electrical Characteristics section).

Common Mode DC Currents

In applications like Figure 1 and Figure 3 where the LT6600-10 not only provides lowpass filtering but also level shifts the common mode voltage of the input signal, DC

APPLICATIONS INFORMATION

currents will be generated through the DC path between input and output terminals. Minimize these currents to decrease power dissipation and distortion.

Consider the application in Figure 3. V_{MID} sets the output common mode voltage of the 1st differential amplifier inside the LT6600-10 (see the Block Diagram section) at 2.5V. Since the input common mode voltage is near 0V, there will be approximately a total of 2.5V drop across the series combination of the internal 402Ω feedback resistor and the external 100Ω input resistor. The resulting 5mA common mode DC current in each input path, must be absorbed by the sources V_{IN}^+ and V_{IN}^- . V_{OCM} sets the common mode output voltage of the 2nd differential amplifier inside the LT6600-10, and therefore sets the common mode output voltage of the filter. Since in the example, Figure 3, V_{OCM} differs from V_{MID} by 0.5V, an additional 2.5mA (1.25mA per side) of DC current will flow in the resistors coupling the 1st differential amplifier output stage to filter output. Thus, a total of 12.5mA is used to translate the common mode voltages.

A simple modification to Figure 3 will reduce the DC common mode currents by 36%. If V_{MID} is shorted to V_{OCM} the common mode output voltage of both op amp stages will be 2V and the resulting DC current will be 8mA. Of course, by AC-coupling the inputs of Figure 3, the common mode DC current can be reduced to 2.5mA.

Noise

The noise performance of the LT6600-10 can be evaluated with the circuit of Figure 7.

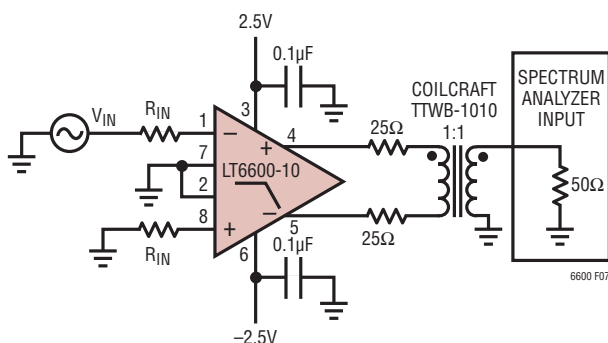

Figure 7. (S8 Pin Numbers)

Given the low noise output of the LT6600-10 and the 6dB attenuation of the transformer coupling network, it will be necessary to measure the noise floor of the spectrum analyzer and subtract the instrument noise from the filter noise measurement.

Example: With the IC removed and the 25Ω resistors grounded, measure the total integrated noise (e_S) of the spectrum analyzer from 10kHz to 10MHz. With the IC inserted, the signal source (V_{IN}) disconnected, and the input resistors grounded, measure the total integrated noise out of the filter (e_O). With the signal source connected, set the frequency to 1MHz and adjust the amplitude until V_{IN} measures 100mV_{P-P}. Measure the output amplitude, V_{OUT} , and compute the passband gain $A = V_{OUT}/V_{IN}$. Now compute the input referred integrated noise (e_{IN}) as:

$$e_{IN} = \frac{\sqrt{(e_O)^2 - (e_S)^2}}{A}$$

Table 1 lists the typical input referred integrated noise for various values of R_{IN} .

Figure 8 is plot of the noise spectral density as a function of frequency for an LT6600-10 with $R_{IN} = 402\Omega$ using the fixture of Figure 7 (the instrument noise has been subtracted from the results).

Table 1. Noise Performance

PASSBAND GAIN (V/V)	R_{IN}	INPUT REFERRED INTEGRATED NOISE 10kHz TO 10MHz	INPUT REFERRED NOISE dBm/Hz
4	100Ω	24μV _{RMS}	-149
2	200Ω	34μV _{RMS}	-146
1	402Ω	56μV _{RMS}	-142

The noise at each output is comprised of a differential component and a common mode component. Using a transformer or combiner to convert the differential outputs to single-ended signal rejects the common mode noise and gives a true measure of the S/N achievable in the system. Conversely, if each output is measured individually and the noise power added together, the resulting calculated noise level will be higher than the true differential noise.

APPLICATIONS INFORMATION

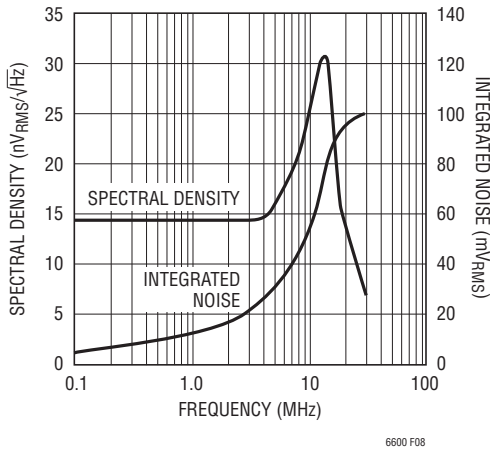

Figure 8

Power Dissipation

The LT6600-10 amplifiers combine high speed with large-signal currents in a small package. There is a need to ensure that the dies’s junction temperature does not exceed 150°C. The LT6600-10 S8 package has Pin 6 fused to the lead frame to enhance thermal conduction when connecting to a ground plane or a large metal trace. Metal trace and plated through-holes can be used to spread the heat generated by the device to the backside of the PC board. For example, on a 3/32" FR-4 board with 2oz copper, a total of 660 square millimeters connected to Pin 6 of the LT6600-10 S8 (330 square millimeters on each side of the PC board) will result in a thermal resistance, θ_{JA} , of about 85°C/W. Without the extra metal trace connected to the V^- pin to provide a heat sink, the thermal resistance will be around 105°C/W. Table 2 can be used as a guide when considering thermal resistance.

Table 2. LT6600-10 SO-8 Package Thermal Resistance

COPPER AREA		BOARD AREA (mm ²)	THERMAL RESISTANCE (JUNCTION-TO-AMBIENT)
TOPSIDE (mm ²)	BACKSIDE (mm ²)		
1100	1100	2500	65°C/W
330	330	2500	85°C/W
35	35	2500	95°C/W
35	0	2500	100°C/W
0	0	2500	105°C/W

Junction temperature, T_J , is calculated from the ambient temperature, T_A , and power dissipation, P_D . The power dissipation is the product of supply voltage, V_S , and supply current, I_S . Therefore, the junction temperature is given by:

$$T_J = T_A + (P_D \cdot \theta_{JA}) = T_A + (V_S \cdot I_S \cdot \theta_{JA})$$

where the supply current, I_S , is a function of signal level, load impedance, temperature and common mode voltages.

For a given supply voltage, the worst-case power dissipation occurs when the differential input signal is maximum, the common mode currents are maximum (see the Applications Information section regarding common mode DC currents), the load impedance is small and the ambient temperature is maximum. To compute the junction temperature, measure the supply current under these worst-case conditions, estimate the thermal resistance from Table 2, then apply the equation for T_J . For example, using the circuit in Figure 3 with DC differential input voltage of 250mV, a differential output voltage of 1V, no load resistance and an ambient temperature of 85°C, the supply current (current into V^+) measures 48.9mA. Assuming a PC board layout with a 35mm² copper trace, the θ_{JA} is 100°C/W. The resulting junction temperature is:

$$T_J = T_A + (P_D \cdot \theta_{JA}) = 85 + (5 \cdot 0.0489 \cdot 100) = 109^\circ\text{C}$$

When using higher supply voltages or when driving small impedances, more copper may be necessary to keep T_J below 150°C.

PACKAGE DESCRIPTION

Please refer to <http://www.linear.com/designtools/packaging/> for the most recent package drawings.

DF Package 12-Lead Plastic DFN (4mm × 4mm) (Reference LTC DWG # 05-08-1733 Rev 0)

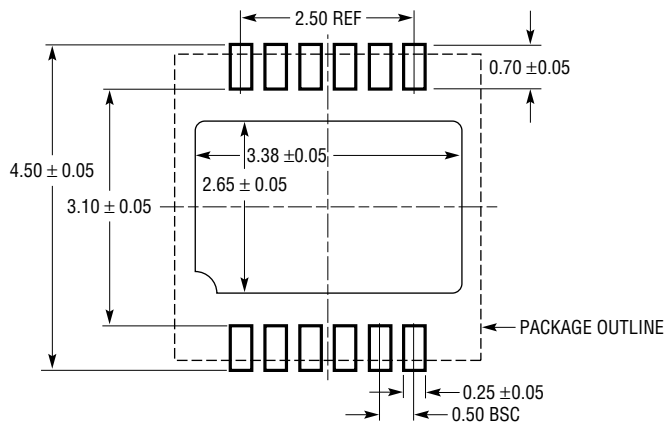

RECOMMENDED SOLDER PAD PITCH AND DIMENSIONS
APPLY SOLDER MASK TO AREAS THAT ARE NOT SOLDERED

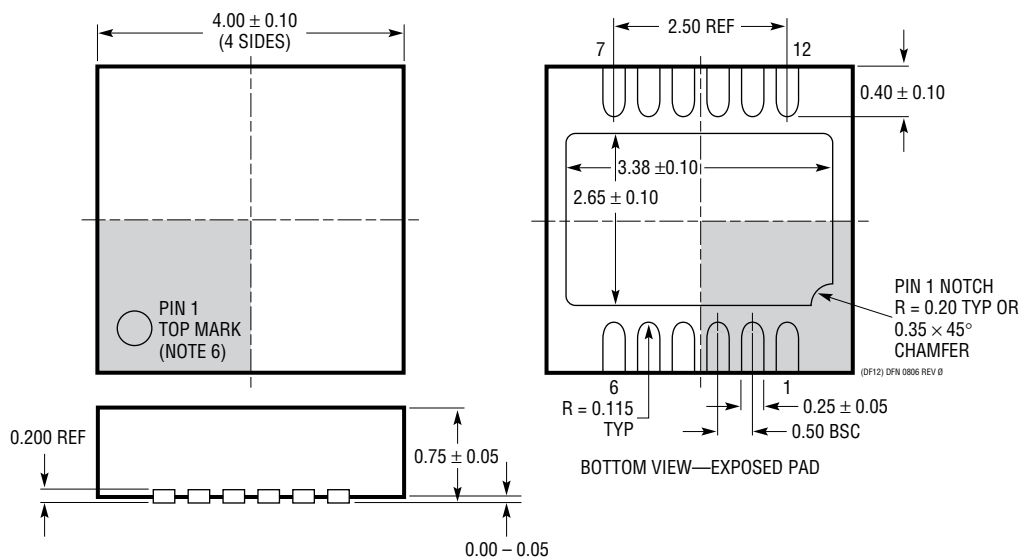

- NOTE:
1. DRAWING IS PROPOSED TO BE MADE A JEDEC PACKAGE OUTLINE MO-220 VARIATION (WGGD-X)—TO BE APPROVED
 2. DRAWING NOT TO SCALE
 3. ALL DIMENSIONS ARE IN MILLIMETERS
 4. DIMENSIONS OF EXPOSED PAD ON BOTTOM OF PACKAGE DO NOT INCLUDE MOLD FLASH. MOLD FLASH, IF PRESENT, SHALL NOT EXCEED 0.15mm ON ANY SIDE
 5. EXPOSED PAD SHALL BE SOLDER PLATED
 6. SHADED AREA IS ONLY A REFERENCE FOR PIN 1 LOCATION ON THE TOP AND BOTTOM OF PACKAGE

PACKAGE DESCRIPTION

Please refer to <http://www.linear.com/designtools/packaging/> for the most recent package drawings.

S8 Package 8-Lead Plastic Small Outline (Narrow .150 Inch) (Reference LTC DWG # 05-08-1610)

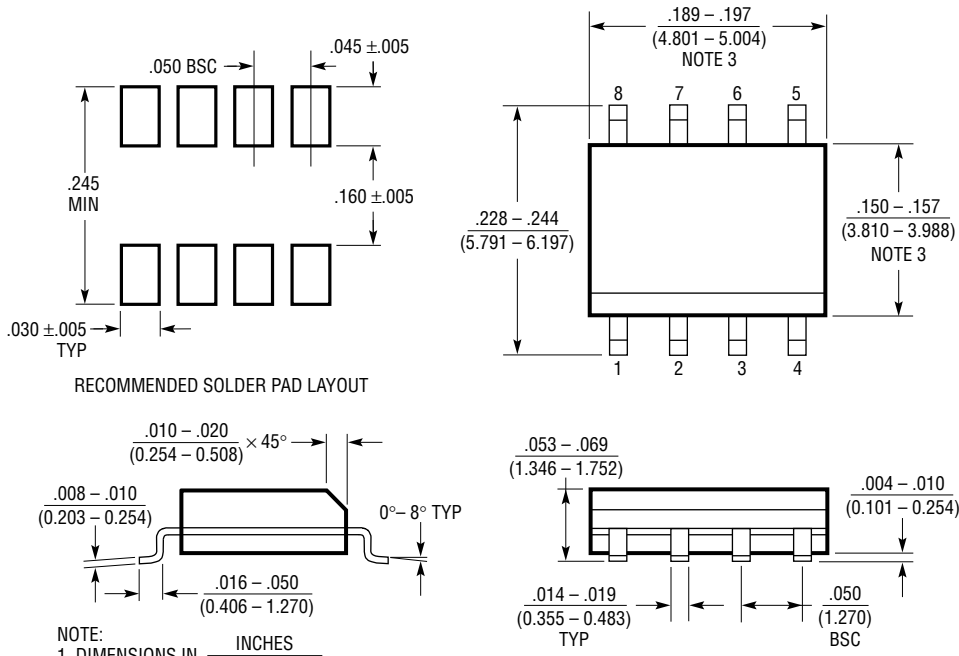

- NOTE:
 1. DIMENSIONS IN $\frac{\text{INCHES}}{\text{MILLIMETERS}}$
 2. DRAWING NOT TO SCALE
 3. THESE DIMENSIONS DO NOT INCLUDE MOLD FLASH OR PROTRUSIONS.
 MOLD FLASH OR PROTRUSIONS SHALL NOT EXCEED $.006''$ (0.15mm)

S08 0303

REVISION HISTORY (Revision history begins at Rev D)

REV	DATE	DESCRIPTION	PAGE NUMBER
D	5/10	Updated Order Information section	2
E	10/11	Corrected Conditions for Voltage at V_{MID} (Pin 7) and Power Supply Current	4

TYPICAL APPLICATIONS

**5th Order, 10MHz Lowpass Filter
(S8 Pin Numbers Shown)**

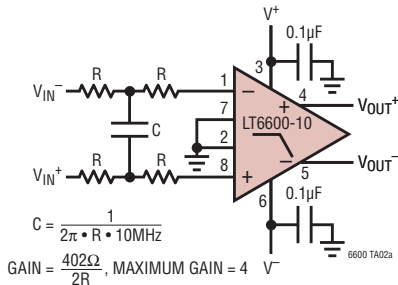

Amplitude Response

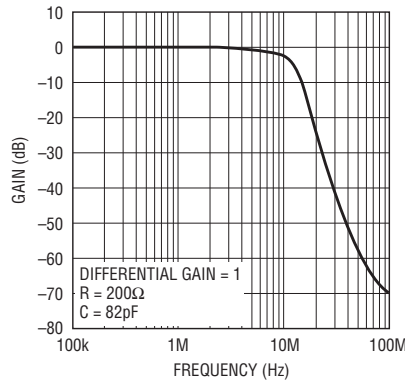

**Transient Response
5th Order, 10MHz Lowpass Filter
Differential Gain = 1**

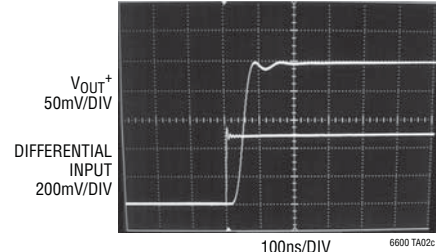

**Amplitude Respo A WCDMA Transmit Filter
(10MHz Lowpass Filter with a 28MHz Notch, S8 Pin Numbers Shown)**

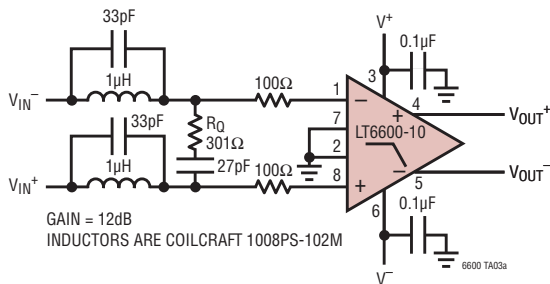

Amplitude Response

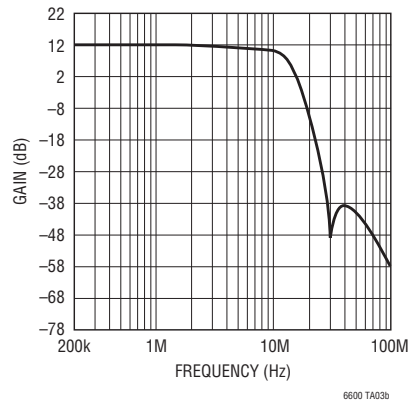

RELATED PARTS

PART NUMBER	DESCRIPTION	COMMENTS
LTC®1565-31	650kHz Linear Phase Lowpass Filter	Continuous Time, SO8 Package, Fully Differential
LTC1566-1	Low Noise, 2.3MHz Lowpass Filter	Continuous Time, SO8 Package, Fully Differential
LT1567	Very Low Noise, High Frequency Filter Building Block	1.4nV/√Hz Op Amp, MSOP Package, Differential Output
LT1568	Very Low Noise, 4th Order Building Block	Lowpass and Bandpass Filter Designs Up to 10MHz, Differential Outputs
LTC6600-2.5	Very Low Noise, Differential Amplifier and 2.5MHz Lowpass Filter	Adjustable Output Common Mode Voltage
LTC6600-20	Very Low Noise, Differential Amplifier and 20MHz Lowpass Filter	Adjustable Output Common Mode Voltage