

# NX7537BF-AA

Data Sheet

R08DS0006EJ0400

Rev.4.00

Feb 28, 2011

## LASER DIODE

1 550 nm InGaAsP MQW-FP LASER DIODE COAXIAL MODULE FOR OTDR APPLICATION

### DESCRIPTION

The NX7537BF-AA is a 1 550 nm Multiple Quantum Well (MQW) structured Fabry-Perot (FP) laser diode coaxial module with single mode fiber. This module is specified to operate under pulsed condition and designed for light source of Optical Time Domain Reflectometer (OTDR).

### FEATURES

- High output power  $P_r = 120 \text{ mW MIN. @ } I_{FP} = 1\,000 \text{ mA}^{*1}$
- Long wavelength  $\lambda_c = 1\,550 \text{ nm}$

\*1 Pulse Conditions: Pulse width (PW) = 10  $\mu\text{s}$ , Duty = 1%



The mark <R> shows major revised points.

The revised points can be easily searched by copying an "<R>" in the PDF file and specifying it in the "Find what:" field.

**NX7537BF-AA**

<R> **PACKAGE DIMENSIONS (UNIT: mm)**

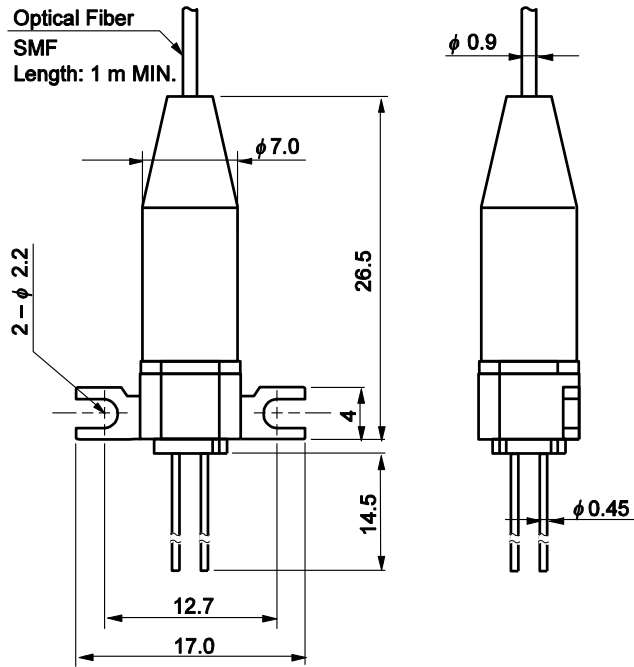

**PIN CONNECTIONS**

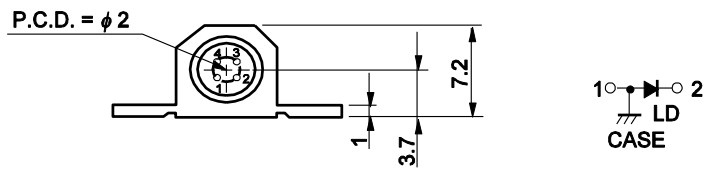

## NX7537BF-AA

### OPTICAL FIBER CHARACTERISTICS

Parameter	Specification	Unit
Mode Field Diameter	9.3±0.5	μm
Cladding Diameter	125±2	μm
Maximum Cladding Noncircularity	2	%
Maximum Core/Cladding Concentricity	1.6	%
Outer Diameter	0.9±0.1	mm
Cut-off Wavelength	1 140 to 1 280	nm
Minimum Fiber Bending Radius	30	mm
Fiber Length	1 000 MIN.	mm

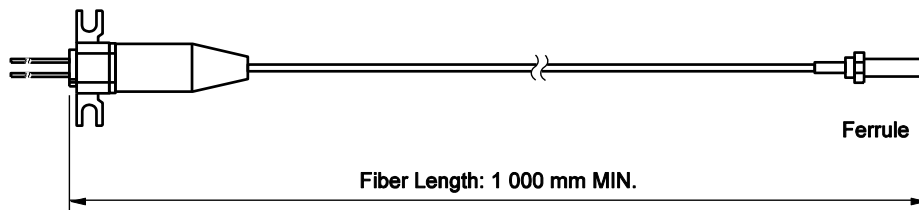

## NX7537BF-AA

### ORDERING INFORMATION

Part Number	Flange Type	Pf (MIN.)
NX7537BF-AA	flat mount flange	120

### ABSOLUTE MAXIMUM RATINGS (T<sub>c</sub> = 25°C, unless otherwise specified)

Parameter	Symbol	Ratings	Unit
Pulsed Forward Current <sup>*1</sup>	I <sub>FP</sub>	1.2	A
Reverse Voltage	V <sub>R</sub>	2.0	V
Operating Case Temperature	T <sub>c</sub>	-20 to +60	°C
Storage Temperature	T <sub>stg</sub>	-40 to +85	°C
Lead Soldering Temperature	T <sub>slid</sub>	350 (3 sec.)	°C
Relative Humidity (noncondensing)	RH	85	%

\*1 Pulse Condition: Pulse Width (PW) = 10 μs, Duty = 1%

### ELECTRO-OPTICAL CHARACTERISTICS (T<sub>c</sub> = 25°C)

Parameter	Symbol	Conditions	MIN.	TYP.	MAX.	Unit
Forward Voltage	V <sub>FP</sub>	I <sub>FP</sub> = 1 000 mA, PW = 10 μs, Duty = 1%		2.5	4.0	V
Threshold Current	I <sub>th</sub>			45	75	mA
Optical Output Power from Fiber	P <sub>f</sub>	I <sub>FP</sub> = 1 000 mA, PW = 10 μs, Duty = 1%	120	145		mW
Center Wavelength	λ <sub>c</sub>	RMS (-20 dB), I <sub>FP</sub> = 1 000 mA, PW = 10 μs, Duty = 1%	1 530	1 550	1 570	nm
Spectral Width	σ	RMS (-20 dB), I <sub>FP</sub> = 1 000 mA, PW = 10 μs, Duty = 1%		7.5	10.0	nm
Rise Time	t <sub>r</sub>	10-90%			2.0	ns
Fall Time	t <sub>f</sub>	90-10%			2.0	ns

### ELECTRO-OPTICAL CHARACTERISTICS (T<sub>c</sub> = 0 to +60°C)

Parameter	Symbol	Conditions	MIN.	TYP.	MAX.	Unit
Threshold Current	I <sub>th</sub>				100	mA
Optical Output Power from Fiber	P <sub>f</sub>	I <sub>FP</sub> = 1000 mA, PW = 10 μs, Duty = 1%	60			mW
Center Wavelength	λ <sub>c</sub>	RMS (-20 dB), I <sub>FP</sub> = 1 000 mA, PW = 10 μs, Duty = 1%	1 520		1 585	nm
Temperature Dependency of Center Wavelength	Δλ/ΔT			0.35		nm/°C
Spectral Width	σ	RMS (-20 dB), I <sub>FP</sub> = 1 000 mA, PW = 10 μs, Duty = 1%			10	nm

**NX7537BF-AA**

**TYPICAL CHARACTERISTICS (T<sub>c</sub> = 25°C, unless otherwise specified)**

**OPTICAL OUTPUT POWER FROM FIBER vs. PULSED FORWARD CURRENT**

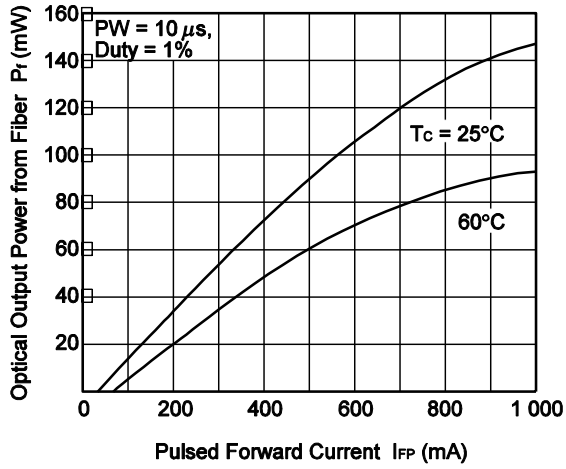

**SPECTRUM**

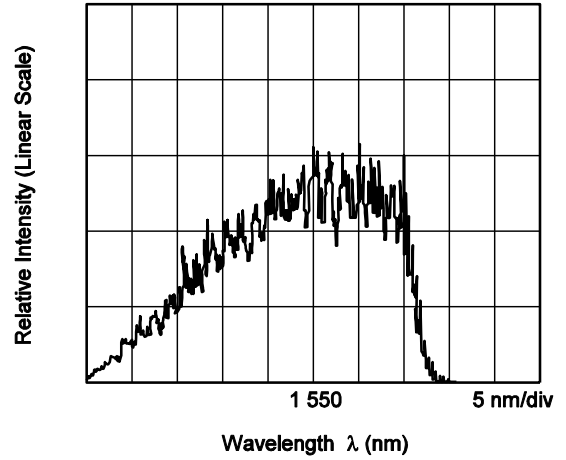

**Remark** The graphs indicate nominal characteristics.

**NX7537BF-AA**

---

**REFERENCE**

Document Name	Document No.
Opto-Electronics Devices Pamphlet <sup>*1</sup>	PX10160E

\*1 Published by the former NEC Electronics Corporation.

**SAFETY INFORMATION ON THIS PRODUCT**

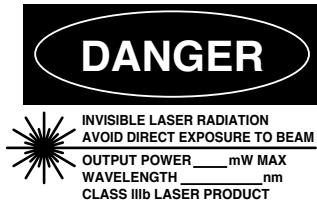

**SEMICONDUCTOR LASER**

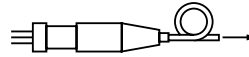

**AVOID EXPOSURE-Invisible**  
 Laser Radiation is emitted from  
 this aperture

<p><b>Warning</b> Laser Beam</p>	<p>A laser beam is emitted from this diode during operation. The laser beam, visible or invisible, directly or indirectly, may cause injury to the eye or loss of eyesight.</p> <ul style="list-style-type: none"> <li>• Do not look directly into the laser beam.</li> <li>• Avoid exposure to the laser beam, any reflected or collimated beam.</li> </ul>
<p><b>Caution</b> GaAs Products</p>	<p>This product uses gallium arsenide (GaAs). GaAs vapor and powder are hazardous to human health if inhaled or ingested, so please observe the following points.</p> <ul style="list-style-type: none"> <li>• Follow related laws and ordinances when disposing of the product. If there are no applicable laws and/or ordinances, dispose of the product as recommended below.                     <ol style="list-style-type: none"> <li>1. Commission a disposal company able to (with a license to) collect, transport and dispose of materials that contain arsenic and other such industrial waste materials.</li> <li>2. Exclude the product from general industrial waste and household garbage, and ensure that the product is controlled (as industrial waste subject to special control) up until final disposal.</li> </ol> </li> <li>• Do not burn, destroy, cut, crush, or chemically dissolve the product.</li> <li>• Do not lick the product or in any way allow it to enter the mouth.</li> </ul>
<p><b>Caution</b> Optical Fiber</p>	<p>A glass-fiber is attached on the product. Handle with care.</p> <ul style="list-style-type: none"> <li>• When the fiber is broken or damaged, handle carefully to avoid injury from the damaged part or fragments.</li> </ul>

<b>Revision History</b>	<b>NX7537BF-AA Data Sheet</b>
-------------------------	-------------------------------

Rev.	Date	Description	
		Page	Summary
-	Jul 2006	-	Previous No. : PL10605EJ02V0DS
3.00	Sep 19, 2010	p.1	Modification of photograph
		p.2, 3	Modification of <b>PACKAGE DIMENSIONS</b>
4.00	Feb 28, 2011	p.2	Modification of <b>PACKAGE DIMENSIONS</b> : MMF -> SMF

All trademarks and registered trademarks are the property of their respective owners.
---



## NOTICE

1. Descriptions of circuits, software and other related information in this document are provided only to illustrate the operation of semiconductor products and application examples. You are fully responsible for the incorporation of these circuits, software, and information in the design of your equipment. California Eastern Laboratories and Renesas Electronics assumes no responsibility for any losses incurred by you or third parties arising from the use of these circuits, software, or information.
2. California Eastern Laboratories has used reasonable care in preparing the information included in this document, but California Eastern Laboratories does not warrant that such information is error free. California Eastern Laboratories and Renesas Electronics assumes no liability whatsoever for any damages incurred by you resulting from errors in or omissions from the information included herein.
3. California Eastern Laboratories and Renesas Electronics do not assume any liability for infringement of patents, copyrights, or other intellectual property rights of third parties by or arising from the use of Renesas Electronics products or technical information described in this document. No license, express, implied or otherwise, is granted hereby under any patents, copyrights or other intellectual property rights of California Eastern Laboratories or Renesas Electronics or others.
4. You should not alter, modify, copy, or otherwise misappropriate any Renesas Electronics product, whether in whole or in part. California Eastern Laboratories and Renesas Electronics assume no responsibility for any losses incurred by you or third parties arising from such alteration, modification, copy or otherwise misappropriation of Renesas Electronics product.
5. Renesas Electronics products are classified according to the following two quality grades: "Standard" and "High Quality". The recommended applications for each Renesas Electronics product depends on the product's quality grade, as indicated below. "Standard": Computers; office equipment; communications equipment; test and measurement equipment; audio and visual equipment; home electronic appliances; machine tools; personal electronic equipment; and industrial robots etc. "High Quality": Transportation equipment (automobiles, trains, ships, etc.); traffic control systems; anti-disaster systems; anti-crime systems; and safety equipment etc. Renesas Electronics products are neither intended nor authorized for use in products or systems that may pose a direct threat to human life or bodily injury (artificial life support devices or systems, surgical implantations etc.), or may cause serious property damages (nuclear reactor control systems, military equipment etc.). You must check the quality grade of each Renesas Electronics product before using it in a particular application. You may not use any Renesas Electronics product for any application for which it is not intended. California Eastern Laboratories and Renesas Electronics shall not be in any way liable for any damages or losses incurred by you or third parties arising from the use of any Renesas Electronics product for which the product is not intended by California Eastern Laboratories or Renesas Electronics.
6. You should use the Renesas Electronics products described in this document within the range specified by California Eastern Laboratories, especially with respect to the maximum rating, operating supply voltage range, movement power voltage range, heat radiation characteristics, installation and other product characteristics. California Eastern Laboratories shall have no liability for malfunctions or damages arising out of the use of Renesas Electronics products beyond such specified ranges.
7. Although Renesas Electronics endeavors to improve the quality and reliability of its products, semiconductor products have specific characteristics such as the occurrence of failure at a certain rate and malfunctions under certain use conditions. Further, Renesas Electronics products are not subject to radiation resistance design. Please be sure to implement safety measures to guard them against the possibility of physical injury, and injury or damage caused by fire in the event of the failure of a Renesas Electronics product, such as safety design for hardware and software including but not limited to redundancy, fire control and malfunction prevention, appropriate treatment for aging degradation or any other appropriate measures. Because the evaluation of microcomputer software alone is very difficult, please evaluate the safety of the final products or systems manufactured by you.
8. Please contact a California Eastern Laboratories sales office for details as to environmental matters such as the environmental compatibility of each Renesas Electronics product. Please use Renesas Electronics products in compliance with all applicable laws and regulations that regulate the inclusion or use of controlled substances, including without limitation, the EU RoHS Directive. California Eastern Laboratories and Renesas Electronics assume no liability for damages or losses occurring as a result of your noncompliance with applicable laws and regulations.
9. Renesas Electronics products and technology may not be used for or incorporated into any products or systems whose manufacture, use, or sale is prohibited under any applicable domestic or foreign laws or regulations. You should not use Renesas Electronics products or technology described in this document for any purpose relating to military applications or use by the military, including but not limited to the development of weapons of mass destruction. When exporting the Renesas Electronics products or technology described in this document, you should comply with the applicable export control laws and regulations and follow the procedures required by such laws and regulations.
10. It is the responsibility of the buyer or distributor of California Eastern Laboratories, who distributes, disposes of, or otherwise places the Renesas Electronics product with a third party, to notify such third party in advance of the contents and conditions set forth in this document, California Eastern Laboratories and Renesas Electronics assume no responsibility for any losses incurred by you or third parties as a result of unauthorized use of Renesas Electronics products.
11. This document may not be reproduced or duplicated in any form, in whole or in part, without prior written consent of California Eastern Laboratories.
12. Please contact a California Eastern Laboratories sales office if you have any questions regarding the information contained in this document or Renesas Electronics products, or if you have any other inquiries.

**NOTE 1:** "Renesas Electronics" as used in this document means Renesas Electronics Corporation and also includes its majority-owned subsidiaries.

**NOTE 2:** "Renesas Electronics product(s)" means any product developed or manufactured by or for Renesas Electronics.

**NOTE 3:** Products and product information are subject to change without notice.

**CEL Headquarters** • 4590 Patrick Henry Drive, Santa Clara, CA 95054 • Phone (408) 919-2500 • [www.cel.com](http://www.cel.com)

For a complete list of sales offices, representatives and distributors,  
Please visit our website: [www.cel.com/contactus](http://www.cel.com/contactus)