

PRODUCT NUMBER  
SEE TABLE

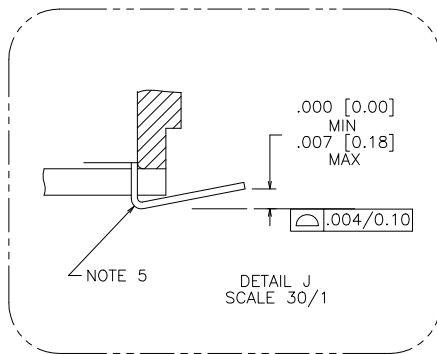
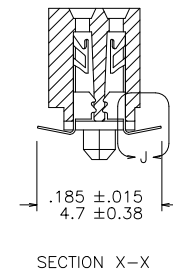
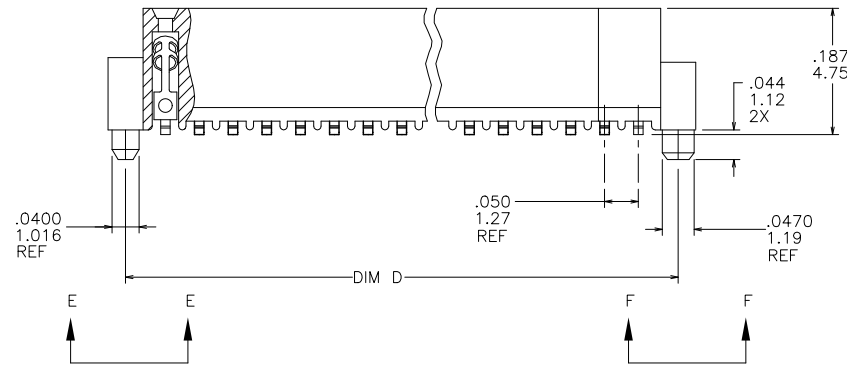
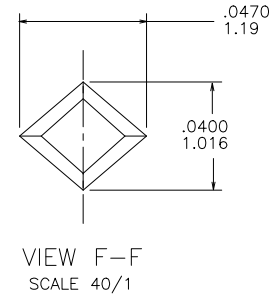
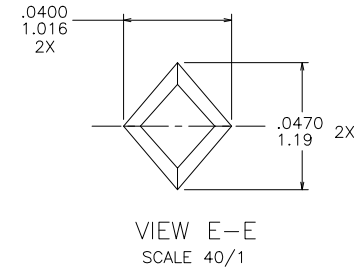
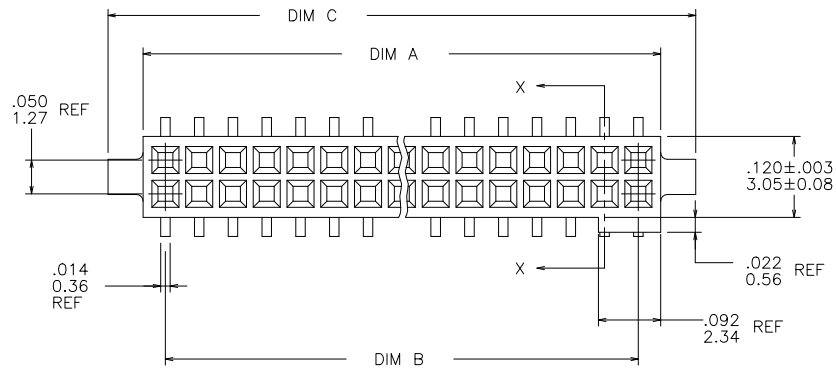

mat'l. code				surface		tolerance		projection		product family		
-				ISO 1302 ✓		ISO 406 ISO 1101				RIB CAGE		
ltr	ecn no	dr	date	tolerances unless otherwise specified				title				
K	V11674	CRG	7/12/01	angles	linear	xx ±.01/.3		INCH/MM		.050/1.27cc V.C.C. SMT		
L	M05-0123	ERE	6/10/05			xxx ±.005/.13				w/POL. .044/1.12 SHORT PEG		
M	M06-0225	ERE	6/12/06	σ±2'			xxxx ±.0020/.050		scale 4:1		dwg no	
N	M06-0370	MHT	9/26/06	dr	M. CRONMAN	12/10/91				sheet 1 of 3 size		
P	M09-0058	MHT	4/06/09	engr	J. SHUEY	8/11/92				91872 A3		
R	N11-0168	YO	5/20/11	chr	G. GINGRICH	8/11/92				type Product Customer Drawing		
S	ELX-N-010204	YO	2/8/12	appd	J. SHUEY	8/11/92						
sheet	revision	S	S	S								
index	sheet	1	2	3								

PRODUCT NO. NOTE 7	SIZE	DIM A	DIM B	DIM C	DIM D	SPECIAL PACKAGING	TAPE WIDTH PITCH	PIECES PER REEL
91872-605	2 X 5	.266/6.76	.200/5.08	.370/9.40	.3200/8.128	NONE	-	-
-610	2 X 10	.516/13.11	.450/11.43	.620/15.75	.5700/14.478	NONE	-	-
-615	2 X 15	.766/19.46	.700/17.78	.870/22.10	.8200/20.828	NONE	-	-
-620	2 X 20	1.016/25.81	.950/24.13	1.120/28.45	1.0700/27.178	NOTE 10	44 mm 12 mm	500
-625	2 X 25	1.266/32.16	1.200/30.48	1.370/34.80	1.3200/33.528	NONE	-	-
-630	2 X 30	1.516/38.51	1.450/36.83	1.620/41.15	1.5700/39.878	NONE	-	-
-635	2 X 35	1.766/44.86	1.700/43.18	1.870/47.50	1.8200/46.228	NONE	-	-
-640	2 X 40	2.016/51.21	1.950/49.53	2.120/53.85	2.0700/52.578	NONE	-	-
-645	2 X 45	2.266/57.56	2.200/55.88	2.370/60.20	2.3200/58.928	NONE	-	-
91872-650	2 X 50	2.516/63.91	2.450/62.23	2.620/66.55	2.5700/65.278	NONE	-	-

NOTES :

- ① HOUSING MATERIAL :  
GLASS FILLED THERMOPLASTIC FLAME RETARDANT PER UL 94V-0  
COLOR: NATURAL
- ② TERMINAL MATERIAL : BeCu
- ③ TERMINAL PLATING :  
30u".76u MIN HARD GOLD OR GXT OVER Ni ON CONTACT ZONES.  
100u"/2.54u MIN Sn OVER Ni IN SOLDERING ZONES.  
OTHERWISE GOLD FLASH OR UNPLATED.
4. APPLICATION INFORMATION :
  - A. RECOMMENDED MOUNTING PAD PATTERN IS SHOWN IN FIGURE "A".
  - B. MATING PINS TO BE .0176/0.447 TO .0181/0.459 THICK.
  - C. MATING PIN TIPS TO BE IN TRUE POSITION TO MATING GRID WITHIN .008/0.20 DIA.
  - D. SUGGESTED MATING PIN LENGTH .130/3.30 ±.010/0.25.
- ⑤ LEAD TIPS TO BE ABOVE HEEL UP TO .007/0.18 MAX.  
COPLANARITY TO BE MEASURED AT LOWEST POINT (HEEL).
6. ADD "CT" TO END DASH NUMBER FOR CONNECTOR WITH VACUUM CAP IN TUBE.
- ⑦ ADD "LF" SUFFIX AT THE END OF PART NUMBER FOR LEAD FREE OPTION.
- ⑧ THIS PRODUCT MEETS EUROPEAN UNION DIRECTIVES AND OTHER COUNTRY REGULATION AS DESCRIBED IN GS-22-008.
9. THE HOUSING WILL WITHSTAND EXPOSURE TO 260°C PEAK TEMPERATURE FOR 20 SECONDS IN A CONVECTION INFRA-RED OR VAPOR PHASE REFLOW OVEN. SEE APPLICATION NOTES/PROCEDURES IF THEY ARE AVAILABLE.
- ⑩ ADD "TR" TO END OF DASH NUMBER FOR TAPE AND REEL PACKAGING WITH CAP. TOOLED ONLY FOR NOTED CONNECTORS.
- 11 PRODUCT SPECIFICATION PER BUS-12-087.

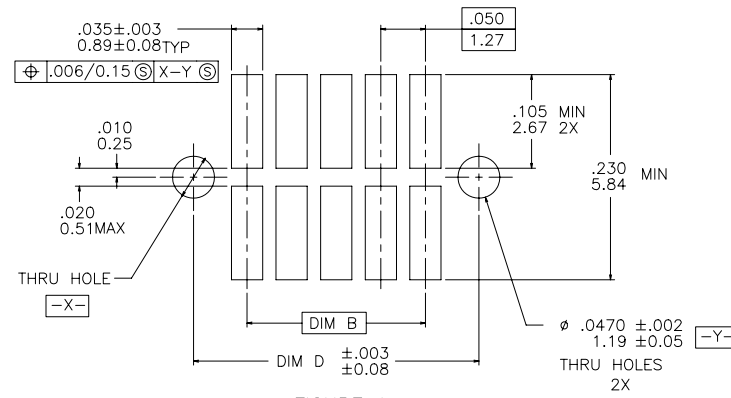

FIGURE A  
RECOMMENDED  
P.C.B. LAYOUT

mat'l. code -		surface ISO 1302 ✓		tolerance ISO 406 ISO 1101		projection INCH/MM		product family RIB CAGE	
ltr	ecn	no	dr	date		tolerances unless otherwise specified		title	
S						angles	linear	.050/1.27cc V.C.C. SMT	
						σ±2'	linear	w/POL. .044/1.12 SHORT PEG	
								scale 4:1	
				dr		M. CRONMAN 12/10/91		dwg no	
				enrg		J. SHUEY 8/11/92		sheet 2 of 3	
				chr		G. GINGRICH 8/11/92		size	
				appd		J. SHUEY 8/11/92		A3	
sheet index		revision sheet						type Product Customer Drawing	

REFERENCE ONLY

UNREELING DIRECTION

TAPE WIDTH'S 32mm AND ABOVE HAS BOTH FEED TRACKS,  
BELOW 32mm HAS TOP FEED TRACK ONLY.

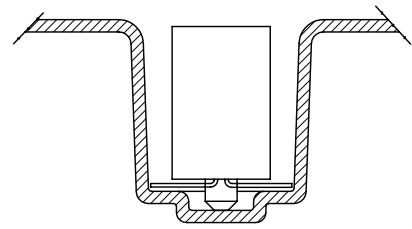
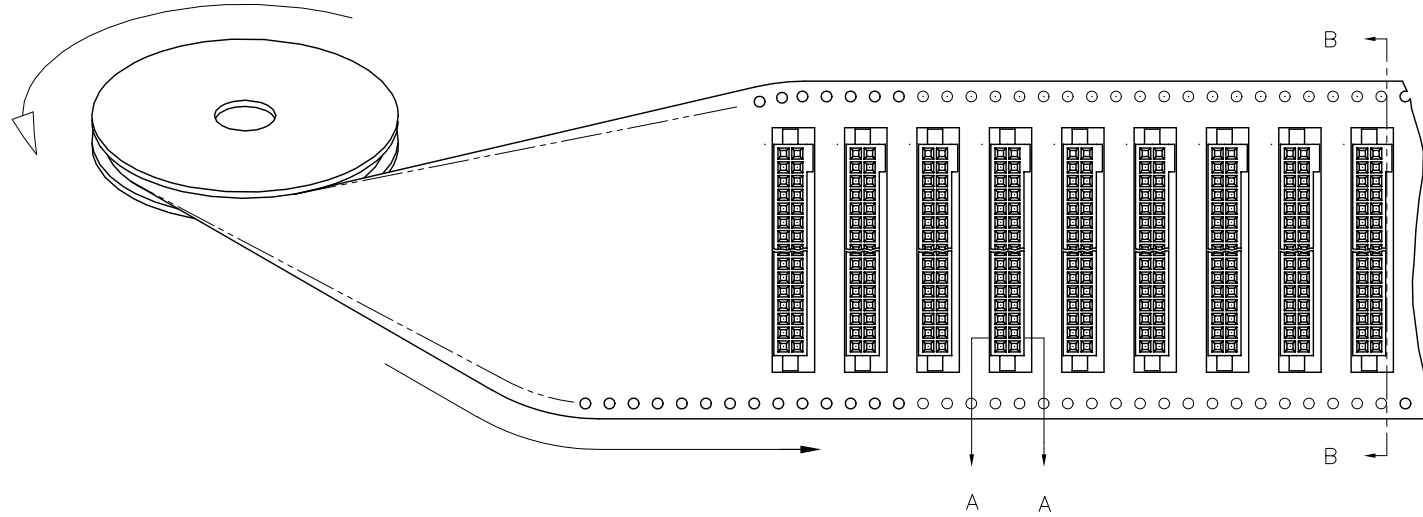

SECTION A-A

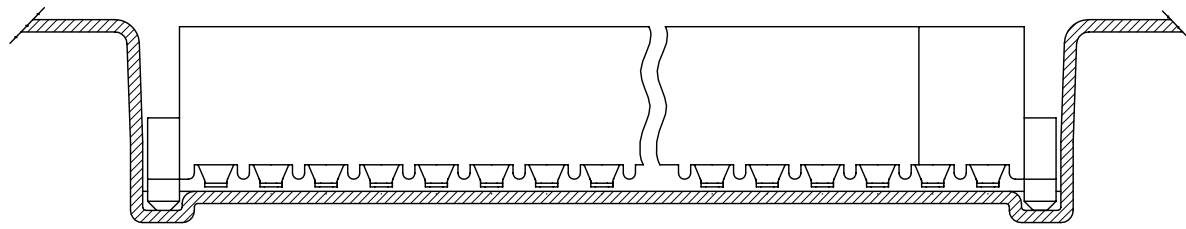

SECTION B-B

mat'l. code		surface		tolerance		projection		product family	
-		ISO 1302 ✓		ISO 406 ISO 1101				RIB CAGE	
ltr	ecn	no	dr	date	tolerances unless otherwise specified			title	
S					angles	linear	$xx \pm .01/.3$ $xxx \pm .005/.13$ $xxxx \pm .0020/.050$	INCH/MM scale 4:1	
					$\sigma \pm 2'$			.050/1.27cc V.C.C. SMT w/POL. .044/1.12 SHORT PEG	
					dr	M. CRONMAN	12/10/91	dwg no 91872 sheet 3 of 3 size A3	
					enr	J. SHUEY	8/11/92		
					chr	G. GINGRICH	8/11/92	type Product Customer Drawing	
					appd	J. SHUEY	8/11/92		
sheet	revision								
index	sheet								