

Telegesis™	 SILICON LABS	TG-PM-510 ZigBee Communications Gateway
ZigBee Communications Gateway		Product Manual 0510r6

Telegesis™ is a trademark of Silicon Laboratories Inc.

Telegesis ZigBee Communications Gateway Product Manual



Rev: 4

Date: April 2014

Table of Contents

1	CHANGE LOG	4
2	ABBREVIATIONS.....	4
3	PACKAGE CONTENTS.....	5
4	SPECIFICATIONS	6
4.1	Order Codes	6
4.2	Examples	6
4.3	Power.....	10
4.4	LED Indicators	11
4.5	Buttons Actions	12
4.5.1	Restore factory defaults	12
4.5.2	Gateway reboot.....	12
4.5.3	Gateway recovery mode	12
4.5.4	Issue ZigBee command.....	12
5	FUNCTIONALITY	13
5.1	Start-up.....	13
5.2	Gateway Discovery	13
5.2.1	Discovery on a windows-7 PC.....	13
5.2.2	Discovery on other platforms:.....	14
5.3	Gateway Webserver.....	15
5.3.1	Authentication	15
5.3.2	Web Pages	16
6	APPENDIX A	30
6.1	Bootloading ETRX3 ZigBee module.....	30
6.2	Cleaning.....	32
7	SOFTWARE LICENSE	32

Table of Figures

Figure 1: Package contents	5
Figure 2: Gateway front view.....	7
Figure 3: Gateway without RS232/RS485 back view	7
Figure 4: Gateway with RS232/RS485 back view	8
Figure 5: Gateway bottom view.....	9
Figure 6: Top label.....	9
Figure 7: Bottom label.....	10
Figure 8: Device Discovery	13
Figure 9: Discovery Python Script.....	14
Figure 10: Discovery Output	14
Figure 11: HTTP server authentication.....	15
Figure 12: Configurations Page.....	16
Figure 13: ZigBee Interface Configurations page	24
Figure 14: Web Terminal page.....	25
Figure 15: Firmware Upgrade page	26
Figure 16: Logout page.....	29
Figure 17: Dialin socket connection.....	30
Figure 18: ETRX3 Bootload prompt	31
Figure 19: Ready to receive upgrade image file via XMODEM.....	32

1 Change Log

Table 1

Version	Date	Comments	Author
1	Aug 28, 2013	Initial draft	Nikhil Sarnaik
2	Oct 13 2013	Button command modified	Nikhil Sarnaik
3	Jan 22, 2014	Added Change Log. Added pinout for RS232/485 ports. Added configuration options for RS232/RS485 ports. Corrected order codes. Restore factory defaults by button updated	Nikhil Sarnaik, Alex Wood
4	April 22,2014	Added license message	Nikhil Sarnaik
5	Oct 17,2014	Added information about IP range filtering for dial in sockets Added Information to enable/disable webpages	Nikhil Sarnaik
6	Jan 16, 2016	Reformatted	David Chalmers

2 Abbreviations

PoE	Power over Ethernet
LED	Light Emitting Diode
HTTP	Hyper Text Transfer Protocol
UPnP	Universal Plug and Play
UDP	User Datagram Protocol
TCP	Transmission Control Protocol
SSL	Secure Socket Layer
DNS	Domain Name System
SNTP	Simple Network Time Protocol
DHCP	Dynamic Host Control Protocol
IP	Internet Protocol
MAC	Media Access Control

3 Package Contents

The package contains the following items,

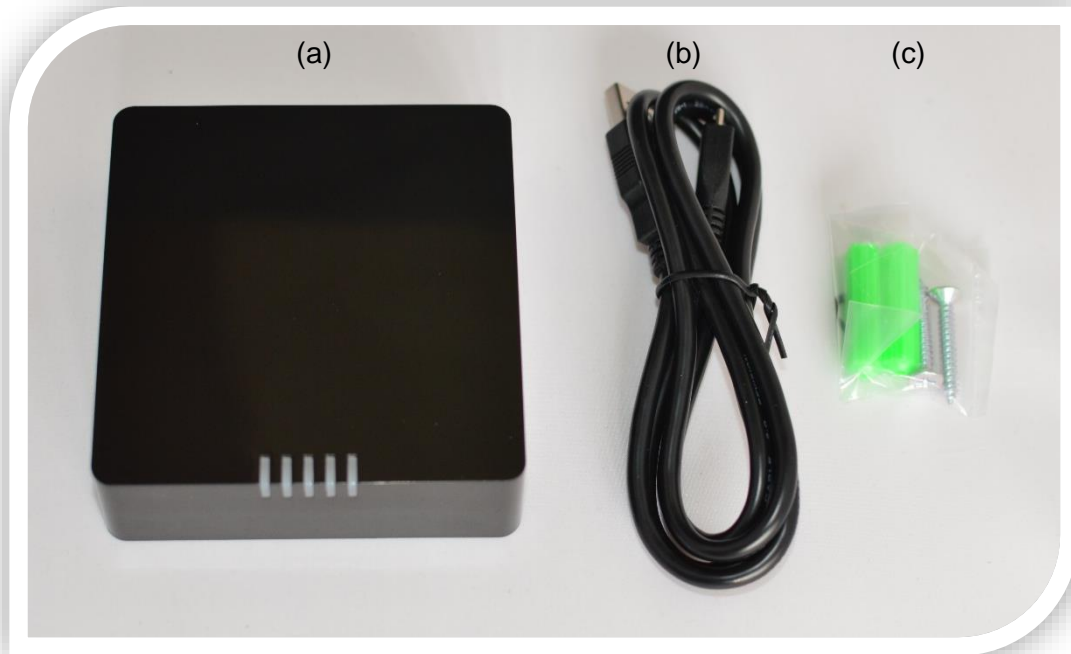

Figure 1: Package contents

- a. ZigBee Communications Gateway
- b. Micro USB power cable
- c. Mounting screws

4 Specifications

Model Number	GW357
RF Interface	ZigBee Pro
RF Output Power	+8dBm
Antenna	Half-wave Dipole Antenna 2dBi Gain or Integrated Antenna
Clock Battery	1x 3V 220mAh Sony CR2032 Battery
Power Source	5Volts @ 500mA via USB Micro Connector Charging source should be current limited
Ethernet	RJ45 10/100Mbps
Power Over Ethernet (optional)	802.3af Compliant Class 1 Device
Operating Temperature	-20 to 70C
Humidity	95% TH Non-condensing
IP Rating	IP20 (subject to testing)
Net Weight	110g
RS485/RS232	Baud rate: 2400, 4800, 9600, 19200, 38400, 57600, 115200 Parity: none, odd, even Stop bits: 1 or 2 RS485 120Ω termination resistor built in

4.1 Order Codes

GW	Gateway	
GW357	Core Silabs IC	
GW357-X	1st module	1 = ETRX357
GW357-0X	2nd module	2 = ETRX357HR
GW357-00-X	Power of Ethernet (P)	3 = ETRX357-LRS
GW357-00-0-X	WiFi or GSM (W or G)	4 = ETRX357-HR-LRS
GW357-00-0-0-X	RS232/RS485 (1=yes 0=No)	
GW357-00-0-0-0-X	SD Memory Card size i.e. 4, 8 etc.	

4.2 Examples

- GW357-11-P-W-1-8 Gateway with 2xETRX357 module, Power-over-Ethernet, WiFi, RS232/RS485 and an 8MB SD Memory Card
- GW357-1 Basic Gateway with 1xETRX357 module
- GW357-30-0-0-1 Gateway with 1xETRX357-LRS and RS232/RS485

Layout

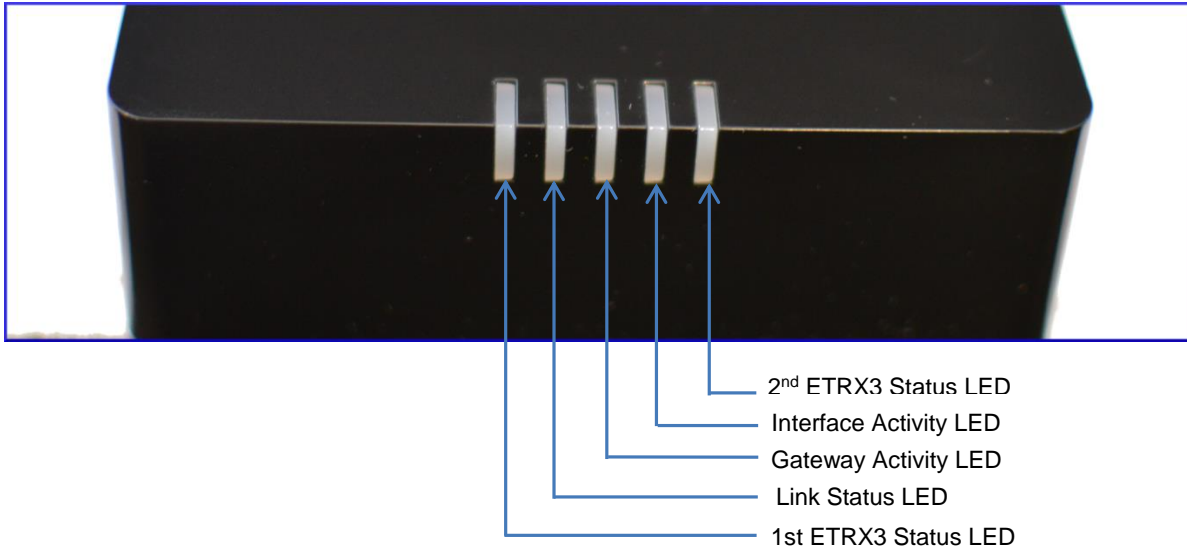

Figure 2: Gateway front view

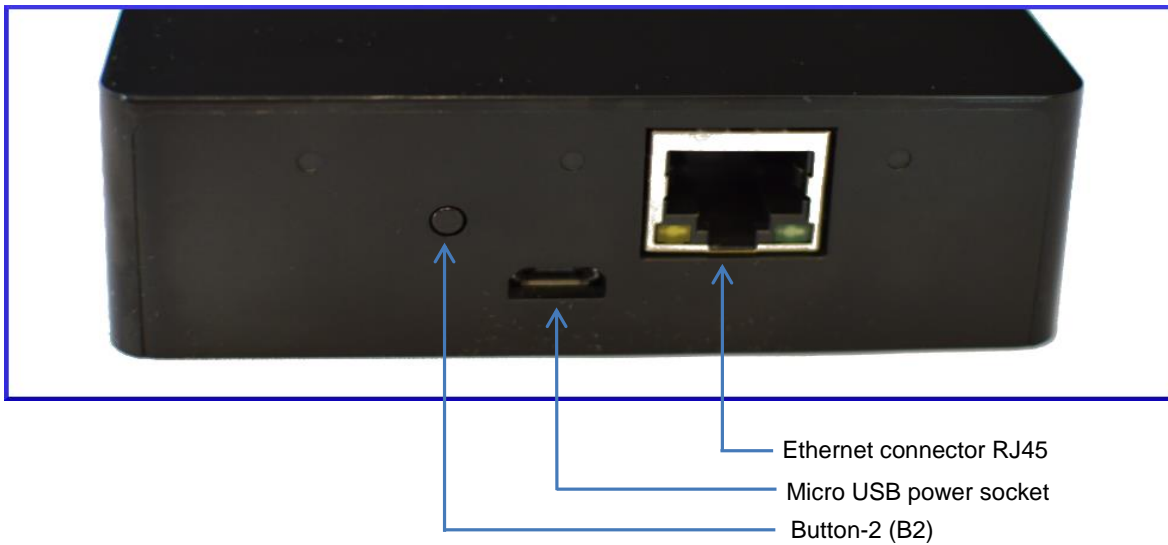

Figure 3: Gateway without RS232/RS485 back view

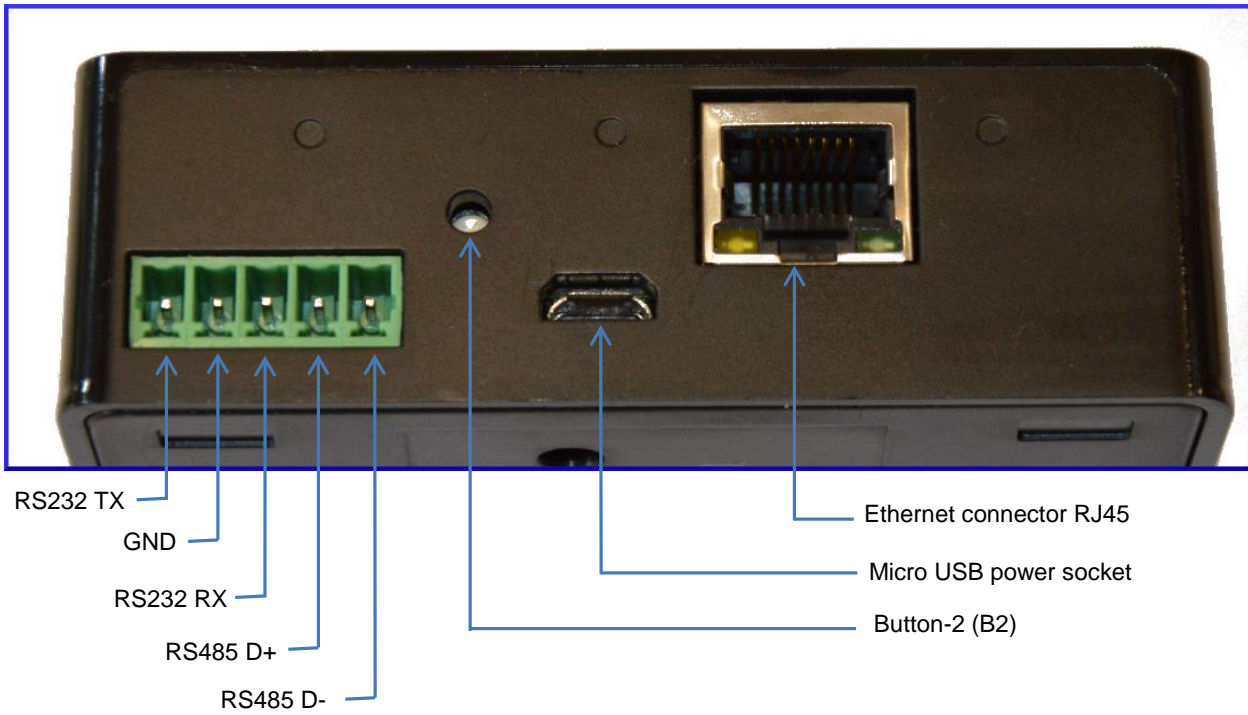

Figure 4: Gateway with RS232/RS485 back view¹

¹ Compatible connectors for RS232/RS485 port
MULTICOMP - MC000099
MULTICOMP - MC000107
MULTICOMP - MC000115



Figure 5: Gateway bottom view

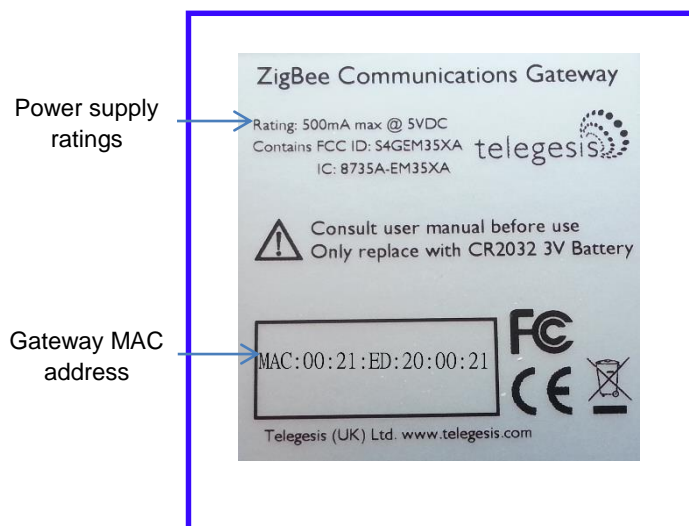

Figure 6: Top label

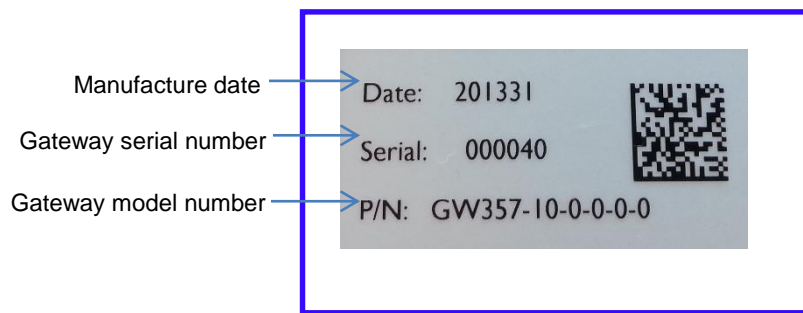
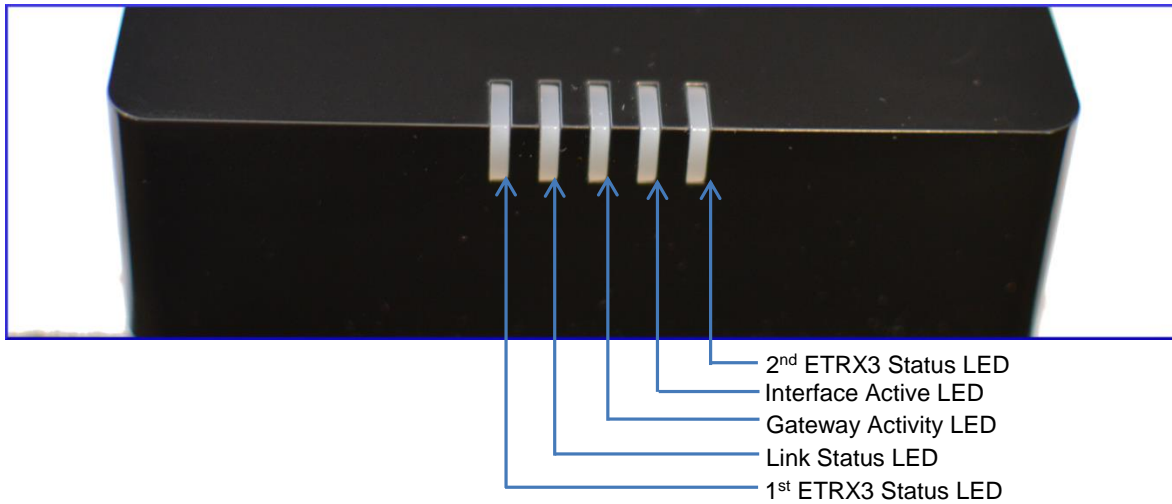

Figure 7: Bottom label

4.3 Power

The Gateway can be powered ON by plugging in the micro USB cable in the socket provided as shown in [figure-3](#) with power source as specified in the [Specifications](#). Selected models of gateway incorporating Power over Ethernet (PoE) can be powered on using the PoE injector through RJ45 cable.

4.4 LED Indicators



Sequence Number	Gateway State	1 st ETRX3 Status LED	Link Status LED	Gateway Activity LED	Interface Active LED	2 nd ETRX3 Status LED
1	Power UP Sequence	ON	Red + Green	Blinking Amber for 5 sec	OFF	ON
All LEDs will turn ON and then following blink one after the other twice except for the ETRX3 Status LEDs which are controlled by ETRX3 ZigBee modules						
2	Ethernet link inactive	-	Red	Blinking Amber	-	-
3	Ethernet link active	-	Green	OFF	-	-
4	Any socket connected to either ZigBee module OR Web Terminal connected	-	-	-	Green	-
5	Any communication with ZigBee modules OR Any communications on Ethernet lines	-	-	Blinking Amber	-	-

Table 2: LED Sequence table

4.5 Buttons Actions

The Gateway has three hardware buttons as shown in the [Layout](#) which can perform multiple functions as described in this section.

1. **Button 1 (B1)**
2. **Button 2 (B2)**
3. **Button 3 (B3)**

4.5.1 Restore factory defaults

Follow the following procedure with buttons in order to restore the factory default configuration settings on the Gateway using **B3** and **B1**.

1. Press and hold **B3**
2. Then with **B3** pressed, press and hold **B1** for approximately 3 seconds after which the Gateway reboots and LED power up sequence is seen.

4.5.2 Gateway reboot

Press **B3** and hold for 5 seconds to reboot the Gateway.

4.5.3 Gateway recovery mode

Perform following procedure to put the Gateway in recovery mode².

1. Press and hold **B3** until gateway reboots.
2. At power up hold **B2** and wait for 3 seconds.
3. The Gateway will be in recovery mode now.

4.5.4 Issue ZigBee command

Button **B2** is used to issue custom ZigBee command to the 1st ETRX3 ZigBee module which can be configured in Button Command section of the [Gateway Configurations](#) as shown below.

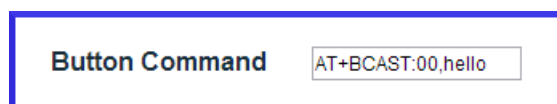

So whenever the B2 is pressed the command ("AT+BCAST:00,hello" by default) is issued to the 1st ETRX3 ZigBee module.

² Recovery mode not implemented in initial release but will be added in subsequent release soon.

5 Functionality

5.1 Start-up

Turn ON the ZigBee Communications Gateway by inserting the micro USB power cable into the socket shown in figure 3. The LEDs on the front panel will light up as described in the [LED's Sequence table](#). Once the Start-up LED sequence is complete the gateway will continuously look for an Ethernet link which is indicated by LED sequence-3. Insert the Ethernet cable in the RJ45 socket shown in figure 3. The gateway will try to obtain an IP address by using DCHP (by default DHCP is enabled but the user can also set static IP address for the Gateway). Once an IP address is allocated successfully the LED sequence-4 is displayed on the LED panel.

5.2 Gateway Discovery

5.2.1 Discovery on a windows-7 PC

Gateway implements UPnP discovery service so the user can directly go to “Network settings” and look for devices under “Network Infrastructure” category. The Gateway will show up as ZigBee Communications Gateway as shown below. Navigate to properties by right clicking on the device to view the device properties. Browse to the IP address shown in the device properties or alternatively double click on the device to navigate to the webpage hosted by Gateway.

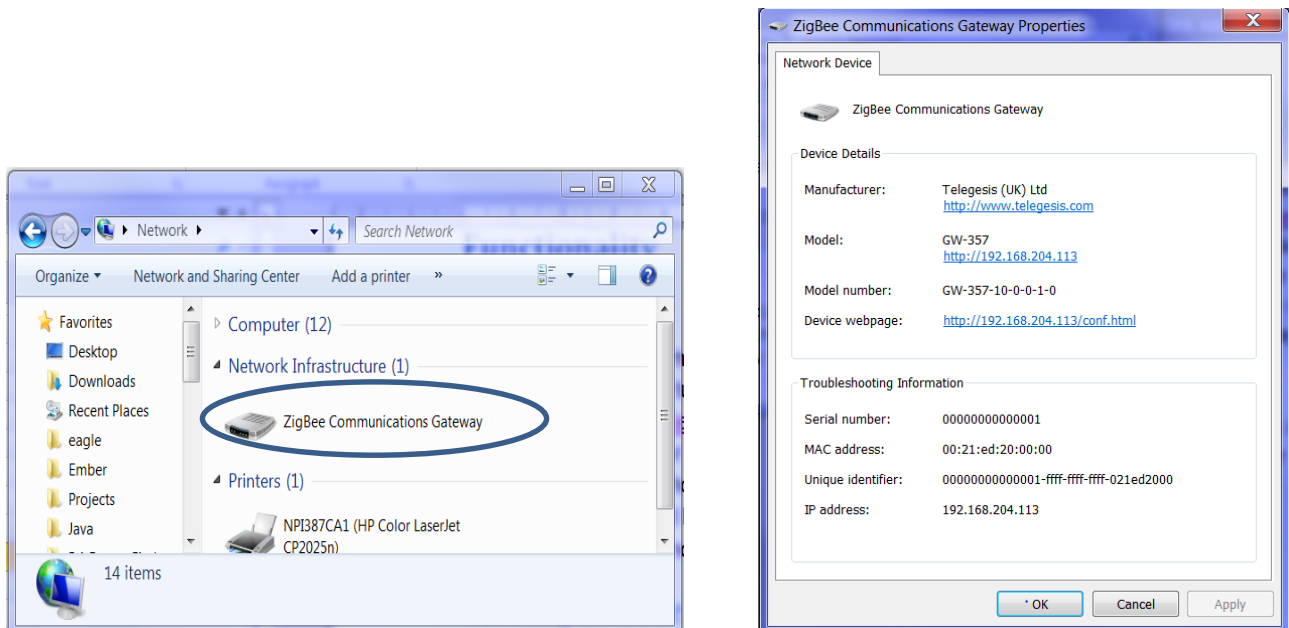

Figure 8: Device Discovery

5.2.2 Discovery on other platforms:

On other platforms where UPnP services are not available, the device can be discovered using the following python script which basically listens to the UDP broadcast on port 14099 by the gateway once every minute.

```
import socket, traceback, commands
host = ''          # Bind to all interfaces
port = 14099

#start a udp socket server to listen on port 14099

s = socket.socket(socket.AF_INET, socket.SOCK_DGRAM)
s.setsockopt(socket.SOL_SOCKET, socket.SO_REUSEADDR, 1)
s.setsockopt(socket.SOL_SOCKET, socket.SO_BROADCAST, 1)
s.bind((host, port))

print "Waiting for Telegesis Gateway:"
while 1:
    try:
        message, address = s.recvfrom(8192)
        print "Telegesis Gateway Found on IP Address:
        %r"%(address[0])
    except (KeyboardInterrupt, SystemExit):
        raise
```

Figure 9: Discovery Python Script

Run the above script from command line and the output window would show the IP addresses of the ZigBee Communications Gateways in the network as shown below

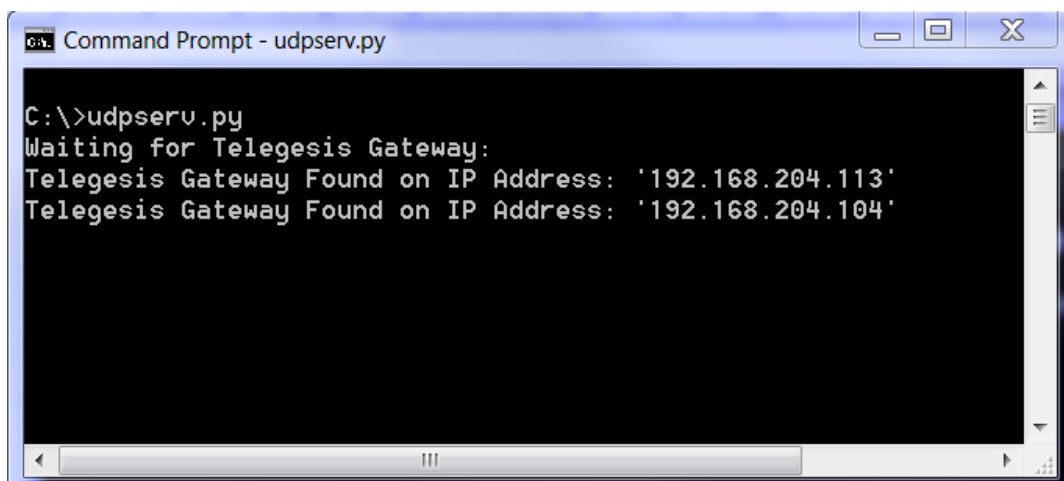

```
Command Prompt - udpserver.py
C:\>udpserver.py
Waiting for Telegesis Gateway:
Telegesis Gateway Found on IP Address: '192.168.204.113'
Telegesis Gateway Found on IP Address: '192.168.204.104'
```

Figure 10: Discovery Output

5.3 Gateway Webserver

ZigBee Communication Gateway hosts a http webserver to serve webpages which help the user to configure the Gateway and communicate with the ZigBee device via a simple web interface.

5.3.1 Authentication

The http webserver is protected by basic authentication hence a valid username **“admin”** and password **“password”** must be provided when prompted to access the webpages. The password can be changed through the GW357 Configuration webpage as explained in the later section.

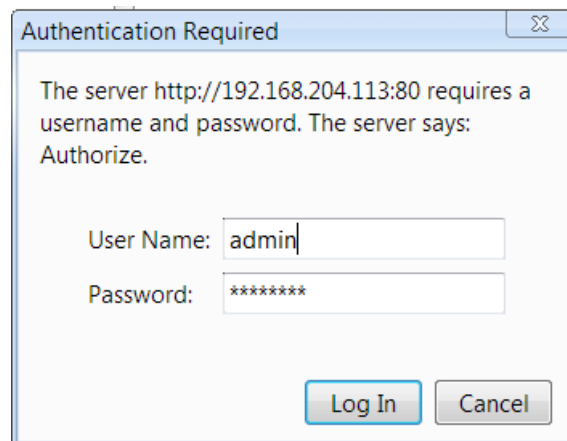

Figure 11: HTTP server authentication

5.3.2 Web Pages

Following web pages are served by the http web server on the ZigBee Communications Gateway

5.3.2.1 GW357 Configuration

The Gateway configuration page is the main page of the http webserver. This page provides access to the configuration parameters of the Gateway.

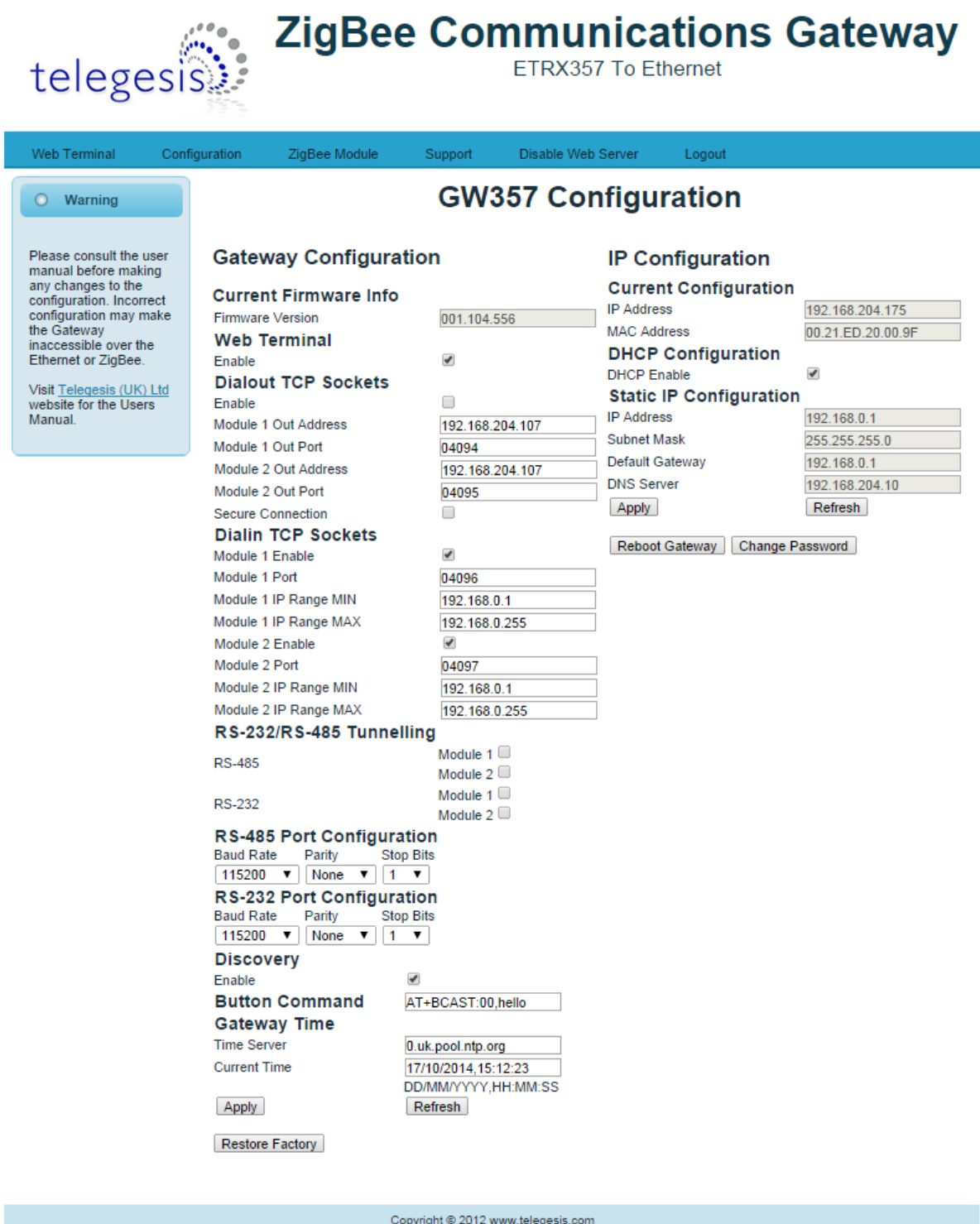

telegesis ZigBee Communications Gateway
ETRX357 To Ethernet

Web Terminal Configuration ZigBee Module Support Disable Web Server Logout

Warning

Please consult the user manual before making any changes to the configuration. Incorrect configuration may make the Gateway inaccessible over the Ethernet or ZigBee.

Visit [Telegesis \(UK\) Ltd website for the Users Manual.](#)

GW357 Configuration

Gateway Configuration

Current Firmware Info
Firmware Version: 001.104.556

Web Terminal
Enable:

Dialout TCP Sockets
Enable:
Module 1 Out Address: 192.168.204.107
Module 1 Out Port: 04094
Module 2 Out Address: 192.168.204.107
Module 2 Out Port: 04095
Secure Connection:

Dialin TCP Sockets
Module 1 Enable:
Module 1 Port: 04096
Module 1 IP Range MIN: 192.168.0.1
Module 1 IP Range MAX: 192.168.0.255
Module 2 Enable:
Module 2 Port: 04097
Module 2 IP Range MIN: 192.168.0.1
Module 2 IP Range MAX: 192.168.0.255

RS-232/RS-485 Tunnelling
RS-485: Module 1 Module 2
RS-232: Module 1 Module 2

RS-485 Port Configuration
Baud Rate: 115200 Parity: None Stop Bits: 1

RS-232 Port Configuration
Baud Rate: 115200 Parity: None Stop Bits: 1

Discovery
Enable:

Button Command
AT+BCAST:00,hello

Gateway Time
Time Server: 0.uk.pool.ntp.org
Current Time: 17/10/2014,15:12:23
DD/MM/YYYY,HH:MM:SS

Apply Refresh Restore Factory

IP Configuration

Current Configuration
IP Address: 192.168.204.175
MAC Address: 00.21.ED.20.00.9F

DHCP Configuration
DHCP Enable:

Static IP Configuration
IP Address: 192.168.0.1
Subnet Mask: 255.255.255.0
Default Gateway: 192.168.0.1
DNS Server: 192.168.204.10

Apply Refresh Reboot Gateway Change Password

Copyright © 2012 www.telegesis.com

Figure 12: Configurations Page

5.3.2.1.1 Gateway Configuration

a. Current Firmware Info

This field gives information about the current firmware running on the gateway.

b. Web Terminal

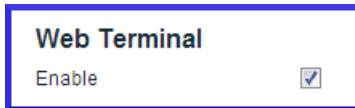

This option enables or disables the access to ZigBee module via the web terminal. The Gateway provides an access to the ZigBee module via Web Terminal page which can be used to issue commands to the ZigBee module and monitor the response of the module. The Web Terminal only supports communication in ASCII.

Default value is enabled.

c. Dialout TCP Sockets

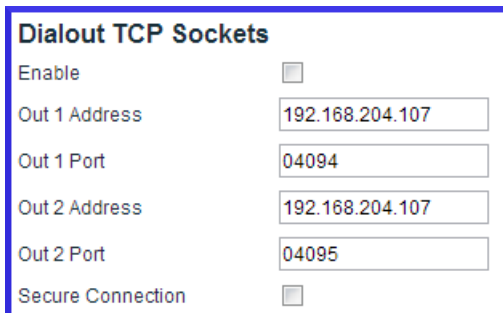

Enable

The Gateway can establish an outgoing TCP socket connections to a specified dialout addresses and port numbers. This option can enable or disable the outgoing socket connections for both the ZigBee modules.

Default value is disabled.

Out 1 Address

The address specified in this option is used by the gateway to establish the outgoing socket connection for the 1st ETRX3 ZigBee module. The dialout address can either be an IP address or a host name.

Out 1 port

This item specifies the port number for the dialout connection from 1st ETRX3 ZigBee module.

Out 2 Address³

The address specified in this option is used by the gateway to establish the outgoing socket connection from the 2nd ETRX3 ZigBee module. The dialout address can either be an IP address or a host name.

³ This option only available in Gateway models with two ZigBee modules on-board. Please refer order codes

Out 2 port³

This item specifies the port number for the dialout connection from 2nd ETRX3 ZigBee module.

Secure Connection

This option enables the SSL on the outgoing socket connection⁴.

d. Dialin TCP Sockets

Dialin TCP Sockets	
Module 1 Enable	<input checked="" type="checkbox"/>
Module 1 Port	<input type="text" value="04096"/>
Module 2 Enable	<input checked="" type="checkbox"/>
Module 2 Port	<input type="text" value="04097"/>

Module 1 Enable

The Gateway also allows an incoming TCP socket connection on a specified port which enables access to the 1st ETRX3 ZigBee module.

Module 1 Port

The IP port number to access the 1st ETRX3 ZigBee module via incoming TCP socket.

Module 1 IP Range MIN

The lowest IP address that can make a dial in socket connection to module 1 on gateway.

Module 1 IP Range MAX

The highest IP address that can make a dial in socket connection to module 1 on gateway.

Module 2 Enable⁵

The Gateway also allows an incoming TCP socket connection on a specified port which enables access to the 2nd ETRX3 ZigBee module.

Module 2 Port⁵

The IP port number to access the 2nd ETRX3 ZigBee module via incoming TCP socket.

Module 2 IP Range MIN⁵

The lowest IP address that can make a dial in socket connection to module 2 on gateway.

Module 2 IP Range MAX⁵

The highest IP address that can make a dial in socket connection to module 2 on gateway.

⁴ The SSL is not implemented in current release.

⁵ This option only available in Gateway models with two ZigBee modules on-board. Please refer order codes

e. RS232/RS485 Tunnelling

This is only available on GW357 gateway models which have the RS232\RS485 option (see the order codes table.) A “Module 2” check box will also be present if your GW357 has a second ETRX3 ZigBee module fitted.

This option creates a direct connection between the RS232 or RS485 port on the gateway and the ETRX3 ZigBee module.

The GW357 doesn't support addressing in multidrop networks. Any data received on the RS485 port will be automatically forwarded to the ETRX3 ZigBee module.

f. RS232/RS485 Port Configuration

This option is only available on GW357 gateway models which have the RS232\RS485 option (see the order codes table.)

Here the user can select the RS232 and RS485 port settings. Note: it is recommended (although not a requirement) that the RS232/RS485 port on the gateway and the ETRX3 ZigBee module have the same baud rate. The gateway has a limited capacity to buffer messages; ensuring the baud rates are the same removes the potential for a buffer overflow in the RX or TX paths.

g. Discovery

Discovery
Enabled

This option enables the Gateway to send discovery broadcasts by UDP on port 14099 once every minute. This option is enabled by default.

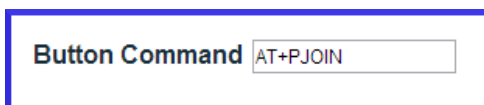
h. Button Command

Button Command

This is a command string that will be sent to the 1st ETRX3 ZigBee module each time the Button-2 (B2) is pressed.

i. Gateway Time

Gateway Time	
Time Server	<input type="text" value="0.uk.pool.ntp.org"/>
Current Time	<input type="text" value="20/08/2013,11:15:33"/>
DD/MM/YYYY,HH:MM:SS	

Time Server

The Gateway implements SNTP client which can update Gateway time from a valid time server specified in time server field.

Current Time

The current time of the gateway is displayed in this field when the page is loaded or is clicked.

After changing any settings on the webpage must be clicked in order to apply the changes to Gateway configuration. Following message will be displayed to confirm the change.

Gateway configurations change successful
--

j. Disable Web Server

The HTTP webserver running on the gateway can be disabled using this option on the configurations page.

Once it is disabled only following page will be accessible to user. This feature is added to avoid any unauthorized or unintended changes in the gateway configuration. A CGI-script can be run on the gateway to re-enable the webserver. The CGI script to re-enable the webserver is **“en-wp.cgi”**

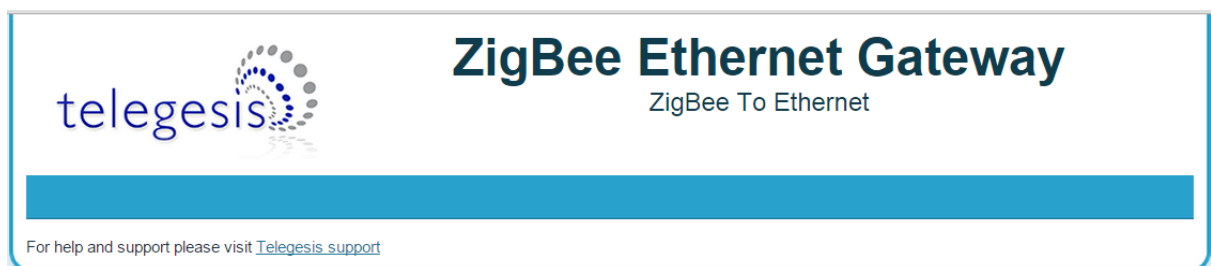

5.3.2.1.2 IP Configuration

a. Current IP Configurations

Current Configuration	
IP Address	192.168.204.113
MAC Address	00.21.ED.20.00.00

IP address

The current IP address of the Gateway is displayed in this field.

MAC address

The MAC address of the Gateway is displayed in this field.

b. DHCP Configuration

DHCP Configuration	
DHCP Enable	<input checked="" type="checkbox"/>

DHCP Enable

If this option is enabled the Gateway can acquire IP configurations like IP address, subnet mask, default gateway and the DNS server dynamically by using DHCP protocol. If the DHCP option is not selected then stored Static IP configuration is used to setup the network interface.

c. Static IP Configurations

Static IP Configuration	
IP Address	192.168.204.121
Subnet Mask	255.255.255.0
Default Gateway	192.168.204.1
DNS Server	192.168.204.10

IP Address

The gateway uses the IP address specified in this field as static IP when DHCP option is not selected.

Subnet Mask

The gateway uses the subnet mask specified in this field as subnet mask when DHCP option is not selected.

Default Gateway

The gateway uses the default gateway specified in this field as default gateway when DHCP option is not selected.

DNS Server

The gateway uses the DNS server specified in this field as DNS server when DHCP option is not selected.

After changing any settings in the IP configuration must be clicked in order to apply the changes in Gateway. Following message will be displayed to confirm the change.

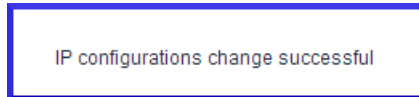

Click refresh to verify if the settings are changed successfully.

5.3.2.1.3 Restoring Factory Defaults

The factory settings can be restored by clicking . The factory defaults can also be restored by combination of hardware button presses as described in [Buttons Actions](#) section. Following are the factory defaults:

Default Gateway Configurations

1. Web Terminal : Enabled
2. Dialout : Disabled
3. Out 1 Address : 192.168.204.107
4. Out 1 Port : 4094
5. Out 1 Address : 192.168.204.107
6. Out 1 Port : 4095
7. Secure Connection⁶ : Disabled
8. Module 1 Enable : Enabled
9. Module 1 Port : 4096
10. Module 2 Enable : Enabled
11. Module 2 Port : 4097
12. Time Server : 0.uk.pool.ntp.org\0
13. Username : admin
14. Password : password

Default IP Configurations

1. DHCP Enable : Enabled
2. Static IP Address : 192.168.204.121
3. Subnet Mask : 255.255.255.0
4. Default Gateway : 192.168.204.10

⁶ The SSL is not implemented in current release.

5.3.2.1.4 Changing the Admin Password

User can change the Gateway's default password by clicking which will display following fields on the configurations page. Fill in all the fields and hit change to apply new password.

Old Password	<input type="text"/>	
New Password	<input type="text"/>	Max 9 chars
Retype New	<input type="text"/>	<input type="button" value="Change"/>

Once the password is changed successfully the following message will be displayed.

Password change successful

Password can also be reset to factory default by restoring factory default configurations mentioned in [Buttons Actions](#).

5.3.2.2 ZigBee Interface Configurations

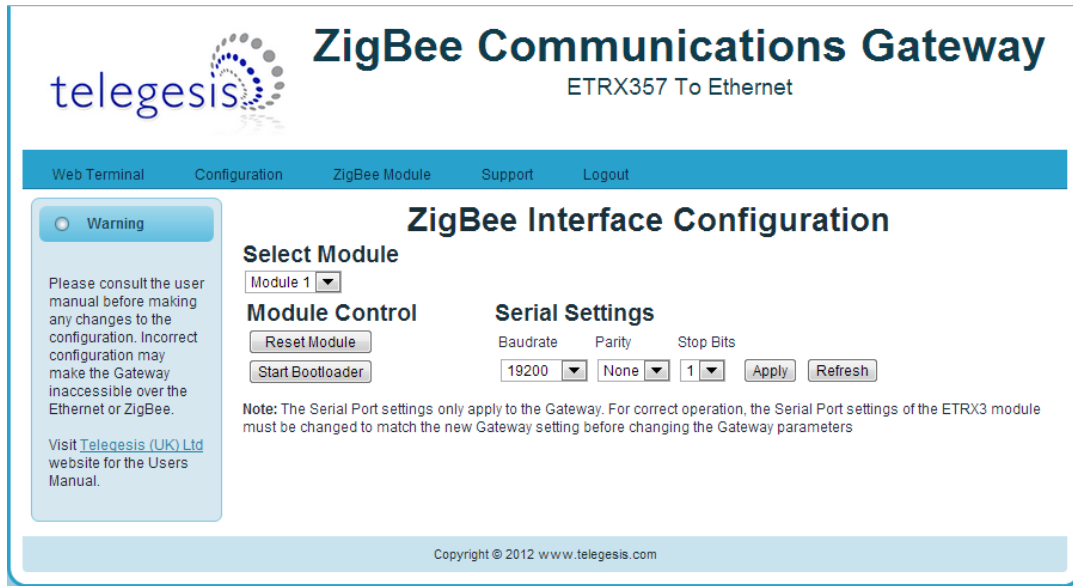

Figure 13: ZigBee Interface Configurations page

The Gateway comes with Telegesis ZigBee AT-commands⁷ Firmware programmed onto the assembled ETRX3 ZigBee module. This firmware communicates at baud rate settings of 19200-8N1. The ZigBee Interface Configurations page is useful to change⁸ the serial settings of the gateway serial ports connected to the ETRX3 ZigBee modules. This page also provides the options to reset the selected ETRX3 ZigBee module and to start the bootloader.

a. Select Module

This field selects the ETRX3 ZigBee module to apply the settings to (there can be two module as per the model number of gateway).

b. Module Control

Reset Module

Click for gateway reset the selected ETRX3 module.

Start Bootloader

Click to start the bootloader on selected ZigBee module. The standard AT-Command firmware has serial Bootloader which can be used to upgrade the ZigBee firmware in the selected module. Process of upgrading ETRX3 ZigBee firmware in standard Gateway is described in the [Appendix A](#). The bootloader is initiated by holding down the PA5 pin of the EM35x and then issuing a hardware reset to the module

c. Serial Settings

Select the serial settings for the selected module and click to apply the settings

⁷ Please refer AT-commands documentation at [Telegesis document centre](#)

⁸ The Serial Port settings only apply to the Gateway. For correct operation, the Serial Port settings of the ETRX3 module must be changed to match the new Gateway setting before changing the Gateway parameters

5.3.2.3 Web-Terminal

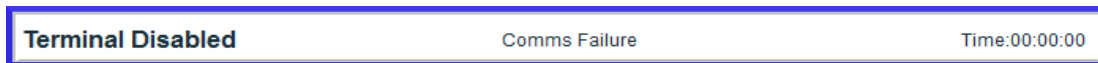

Figure 14: Web Terminal page

The Web Terminal is a simple web interface to communicate with the 1st ETRX3 ZigBee module on the Gateway. User can issue AT-Commands⁹ to the module in ZigBee input command box, click and monitor the response in the ZigBee output window.

The Terminal status shows the current status of the web terminal and the Gateway time is also displayed in the top right of the ZigBee output window,

Terminal Disabled Status:



If the Web Terminal option is disabled in the [Configurations page](#) Terminal status as shown above will be displayed. No commands can be issued to the ZigBee module via Web Terminal if this status is been displayed.

Terminal Enabled Status:



When the Web Terminal connects successfully to the ZigBee module above status will be displayed. The Gateway time will also start updating once every second. Now, the user may enter an AT-Command in ZigBee input box and click issue the command¹⁰ to the ZigBee module and expect the response in approximately one sec.

⁹ Please refer AT-commands documentation at [Telegesis document centre](#)

¹⁰ Note: Pressing Enter Key on Keyboard will NOT send the command but will refresh the page.

5.3.2.4 Firmware Upgrade

The Gateway firmware can be updated over Ethernet. To perform Gateway firmware upgrade, navigate to “http://<gateway_ip_address>/bootload.html” page which looks like below.

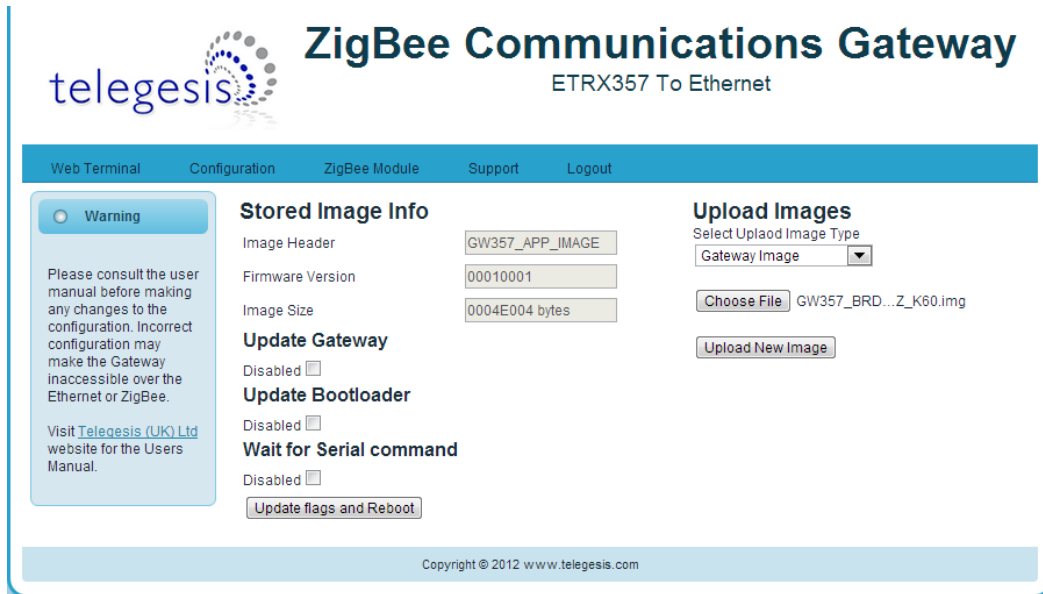
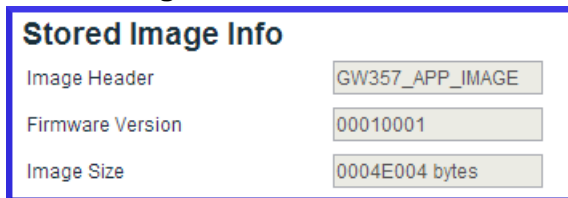

Figure 15: Firmware Upgrade page

Stored Image Info



This section gives the information of the Gateway firmware image stored in the Gateway.

Image Header

Each image stored in the Gateway has an Image Header for identifying the type of image. This field displays the image header of selected Image type.

Firmware Version

This field displays the firmware version of image stored.

Image Size

This field displays the size of stored image in bytes.

Upload Images

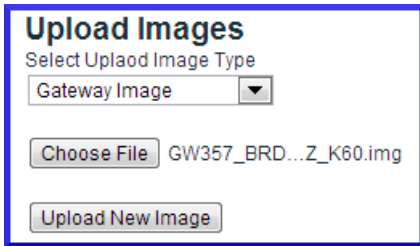

The screenshot shows a web interface titled "Upload Images". It features a dropdown menu labeled "Select Upload Image Type" with "Gateway Image" selected. Below the dropdown is a "Choose File" button, followed by the filename "GW357_BRD...Z_K60.img". At the bottom of the form is an "Upload New Image" button.

Select Upload Image Type:

Select the type of image to be uploaded to the Gateway. Currently Gateway supports three types of images

- a. Gateway Image
This is the gateway upgrade image which will replace the current Gateway firmware when gateway is rebooted with Update Gateway flag enabled.
- b. Bootloader Image
This is the recovery bootloader¹¹ upgrade image which will replace the current secondary bootloader when gateway is rebooted with Update Bootloader flag is enabled.
- c. Configuration Settings Image
All the configurations settings mentioned in [Configurations page](#) can be updated by this image type. The settings will get applied after the gateway is rebooted. No flag is necessary to be enabled for the configuration settings to be update.

Image Upload Process

Click **Choose File** which opens a dialogue box to navigate to the image, navigate to appropriate file and click open.

Now click **Upload New Image** a pop-up box will open to confirm correct file is uploaded. Click OK to proceed. Gateway activity LED will be blinking while the file is being transferred. If the image is uploaded and stored successfully in Gateway "**FW image sent successfully**" message is displayed in a new tab in the browser.

¹¹ Recovery bootloader mechanism is not implemented in the initial release but will be implemented in subsequent release soon.

Update Flags and Reboot

Update Gateway
Disabled

Update Bootloader
Disabled

Wait for Serial command
Disabled

Update Gateway

If this flag is enabled upon reboot the gateway will validate the Gateway Image stored by image upload process mentioned above and updates the gateway firmware if a valid image is present.

Update Bootloader

If this flag is enabled upon reboot the gateway will validate the Bootloader Image stored by the image upload process mentioned above and updates the recovery bootloader firmware if a valid image is present.

Wait for Serial Commands

The Gateway can accept some serial commands at start-up (available only on models with RS232-RS485 port present). If this flag is enabled the gateway will wait for 5 sec to accept any serial commands on the RS232 lines and then jump to the main gateway application.

Enable the appropriate flags and click buttons to upgrade the gateway with stored image.

Upgrading may take few minutes, be patient and do not interrupt the upgrade process until power up sequence is indicated on the LED panel. The upgrade process will be indicated by blinking of gateway activity LED.

5.3.2.5 Support

Support link will redirect to telegesis Support page on the internet <http://www.telegesis.com/support/>

5.3.2.6 Logout

Logout will end current session and “**Logged out successfully**” message will be displayed and the user will need to authenticate with username and password at the next login.



Figure 16: Logout page

6 Appendix A

6.1 Bootloading ETRX3 ZigBee module

The procedure to upgrade firmware on ETRX3 module over a TCP socket is as described below.

1. For this example assume the firmware of 1st ETRX3 ZigBee module is to be updated remotely over a TCP socket.
2. Make sure dialin socket is enabled for the 1st ETRX3 ZigBee module as shown below



Dialin TCP Sockets	
Module 1 Enable	<input checked="" type="checkbox"/>
Module 1 Port	04096
Module 2 Enable	<input checked="" type="checkbox"/>
Module 2 Port	04097

3. Connect to the Gateway's dialin socket for the 1st ETRX3 ZigBee module using Telegesis terminal (Version 4 or higher) as shown below.

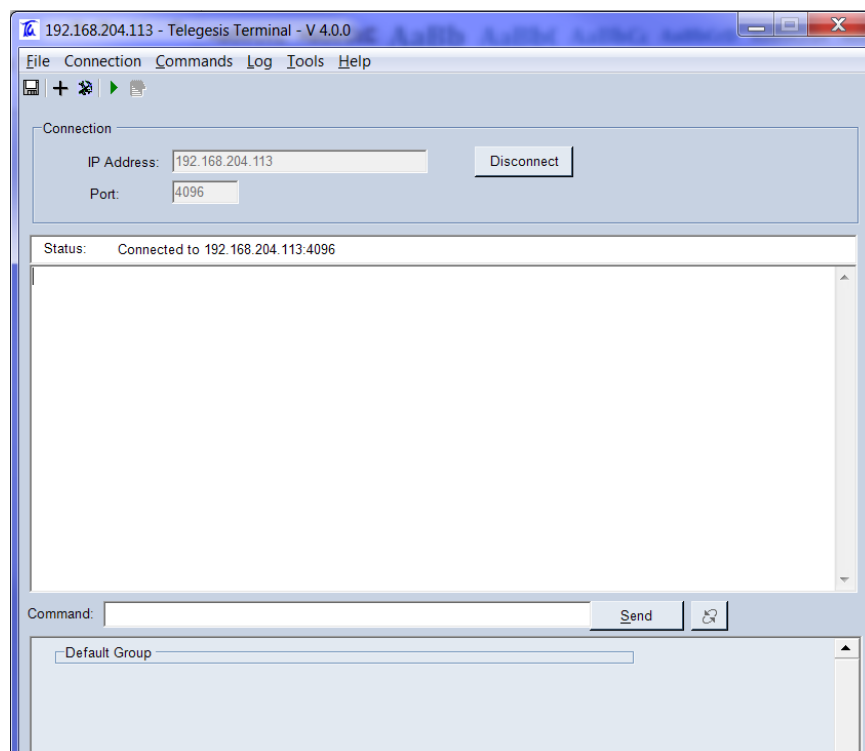
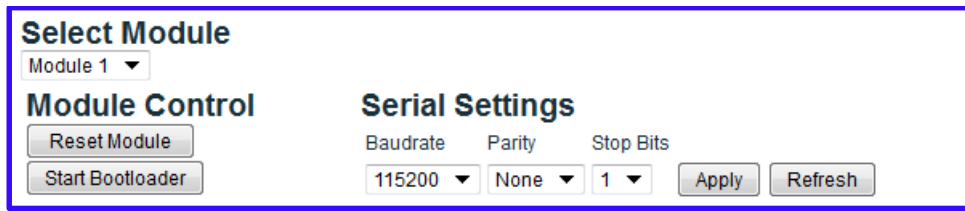

Figure 17: Dialin socket connection

4. The [LED sequence 4](#) should be indicated by LED panel.
5. Navigate to ZigBee Interface Configuration and Select Module 1 as shown below.



6. Click **Start Bootloader** to start the bootloader on selected ZigBee module.
7. Change the baudrate to 115200 and click **Apply**.
8. On Telegesis terminal hit Enter key to see following prompt

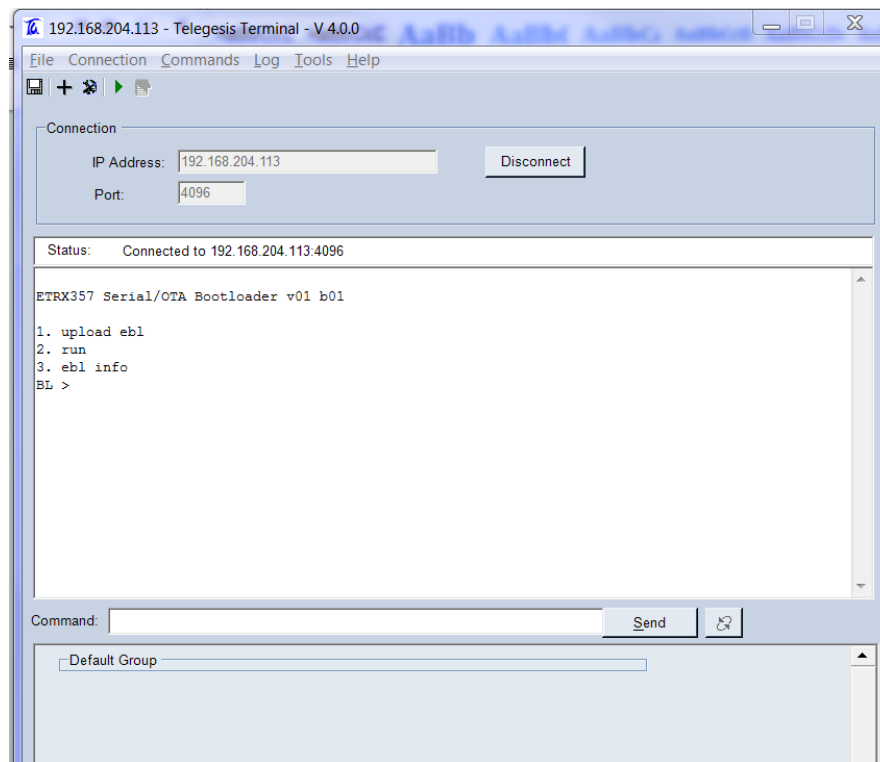

Figure 18: ETRX3 Bootload prompt

9. Press “1” to see character ‘C’ displayed periodically as shown which indicates the ZigBee module is ready to receive upgrade image file via XMODEM

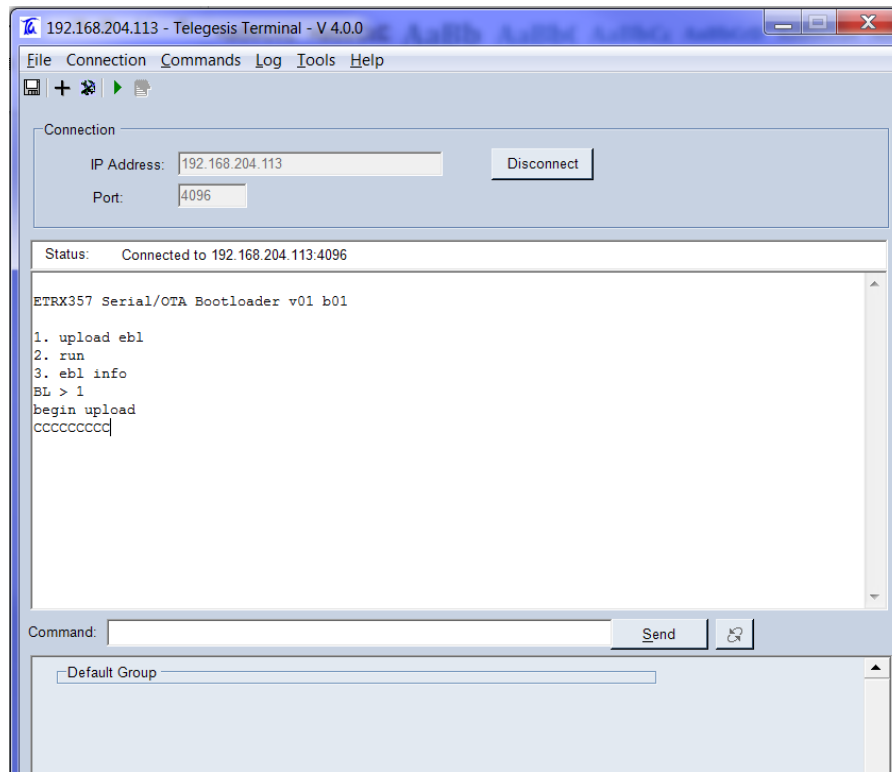
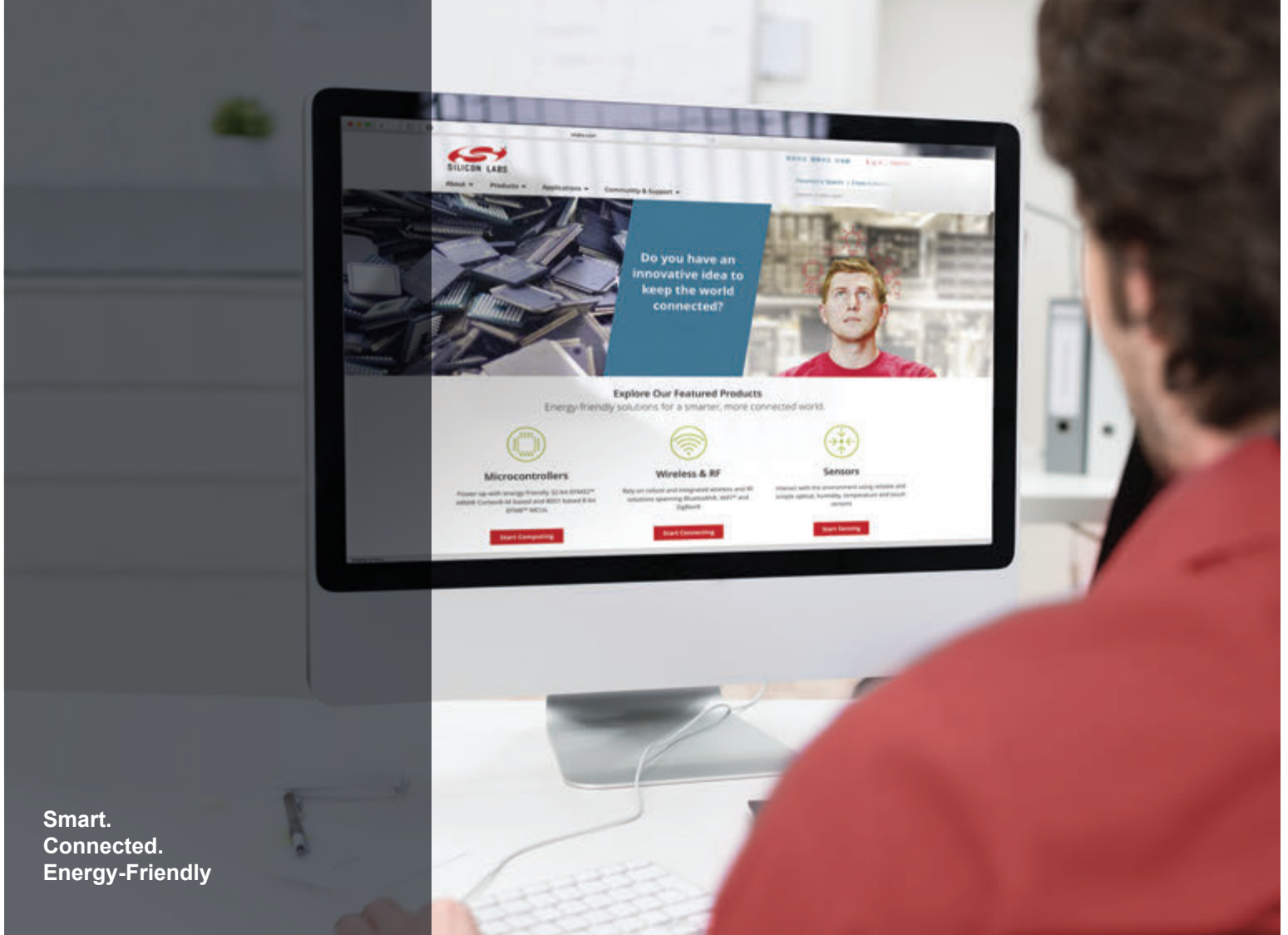

Figure 19: Ready to receive upgrade image file via XMODEM

10. Go to Tools->Transfer File (XMODEM) and send the appropriate upgrade image file.
11. Once successful change the baudrate of module according to upgraded firmware and the ZigBee module will communicate according to the new firmware. For Telegesis R3xx firmware the default baud rate is 19200-8N1

6.2 Cleaning

Dust or wipe only with damp cloth; do not allow moisture to penetrate the enclosure. Do not use aggressive cleaning agents



Smart.
Connected.
Energy-Friendly



Products
www.silabs.com/products



Quality
www.silabs.com/quality



Support and Community
community.silabs.com

Disclaimer

Silicon Laboratories intends to provide customers with the latest, accurate, and in-depth documentation of all peripherals and modules available for system and software implementers using or intending to use the Silicon Laboratories products. Characterization data, available modules and peripherals, memory sizes and memory addresses refer to each specific device, and "Typical" parameters provided can and do vary in different applications. Application examples described herein are for illustrative purposes only. Silicon Laboratories reserves the right to make changes without further notice and limitation to product information, specifications, and descriptions herein, and does not give warranties as to the accuracy or completeness of the included information. Silicon Laboratories shall have no liability for the consequences of use of the information supplied herein. This document does not imply or express copyright licenses granted hereunder to design or fabricate any integrated circuits. The products are not designed or authorized to be used within any Life Support System without the specific written consent of Silicon Laboratories. A "Life Support System" is any product or system intended to support or sustain life and/or health, which, if it fails, can be reasonably expected to result in significant personal injury or death. Silicon Laboratories products are not designed or authorized for military applications. Silicon Laboratories products shall under no circumstances be used in weapons of mass destruction including (but not limited to) nuclear, biological or chemical weapons, or missiles capable of delivering such weapons.

Trademark Information

Silicon Laboratories Inc.®, Silicon Laboratories®, Silicon Labs®, SiLabs® and the Silicon Labs logo®, Bluegiga®, Bluegiga Logo®, Clockbuilder®, CMEMS®, DSPLL®, EFM®, EFM32®, EFR®, Ember®, Energy Micro, Energy Micro logo and combinations thereof, "the world's most energy friendly microcontrollers", Ember®, EZLink®, EZRadio®, EZRadioPRO®, Gecko®, ISModem®, Precision32®, ProSLIC®, Simplicity Studio®, SiPHY®, Telegesis, the Telegesis Logo®, USBXpress® and others are trademarks or registered trademarks of Silicon Laboratories Inc. ARM, CORTEX, Cortex-M3 and THUMB are trademarks or registered trademarks of ARM Holdings. Keil is a registered trademark of ARM Limited. All other products or brand names mentioned herein are trademarks of their respective holders.



SILICON LABS

Silicon Laboratories Inc.
400 West Cesar Chavez
Austin, TX 78701
USA

<http://www.silabs.com>